

D I G I T A L C O M B A T S I M U L A T O R



DCS
SERIES



THE FIGHTER COLLECTION



Eagle Dynamics

AJS 37

V I G G E N



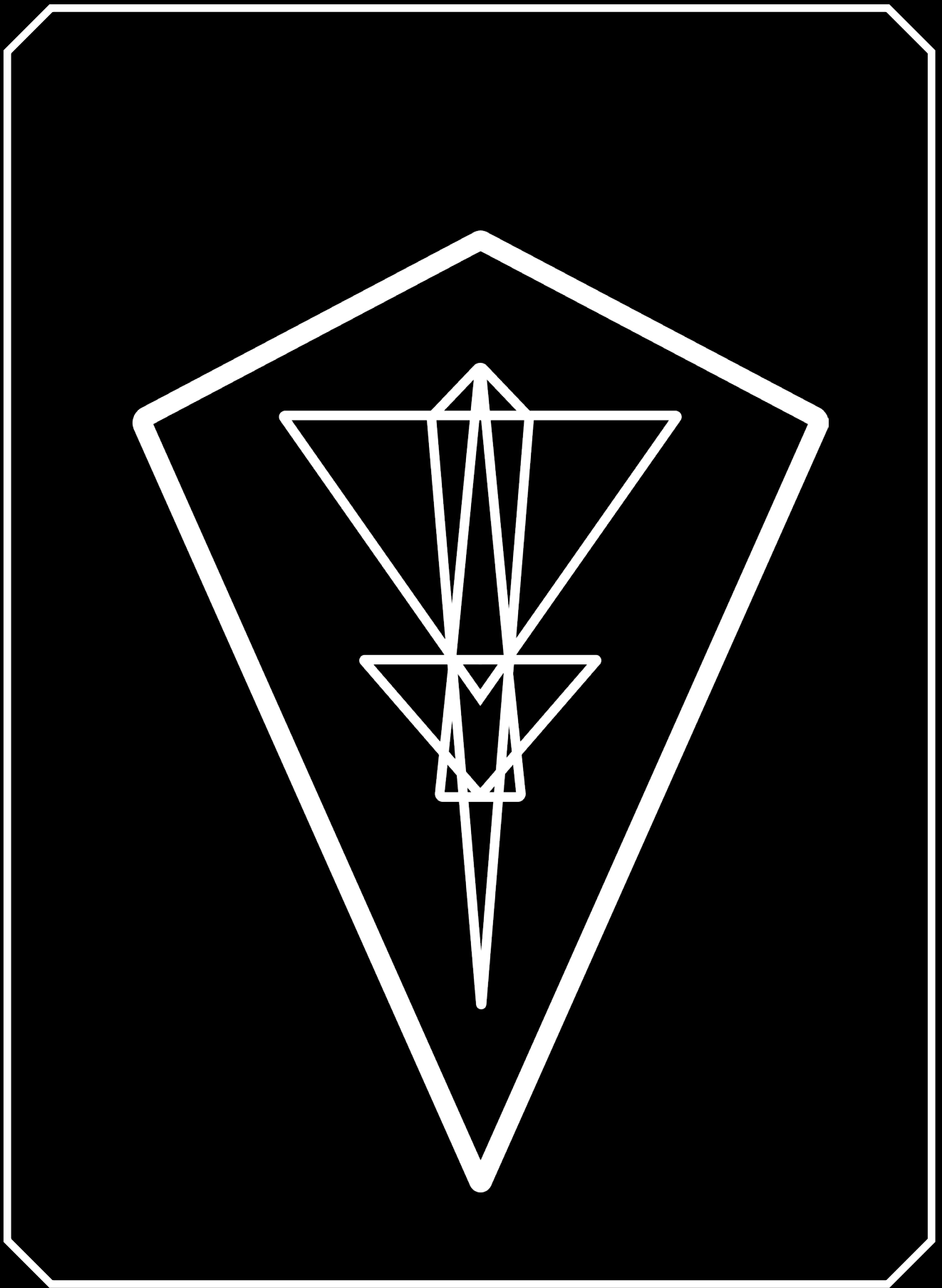

Table of Contents

<u>Introduction</u>	16
Viggen versions.....	17
Historical background.....	17
General specifications	19
Technical data.	19
Fuel capacity.....	19
Performance.....	19
<u>Cockpit Overview</u>	20
General layout	21
Front Panel	22
Left side panel.....	24
Right side panel	26
Front instrument panel	28
Primary Flight instruments	29
Airspeed indicator.....	29
Altimeter.....	29
Attitude Director Indicator, ADI (FLI37)	30
Angle of Attack (alpha, α) indicator.....	31
Course ring and Course index.....	31
Engine instruments	32

RPM indicator 32

EPR indicator 32

Exhaust Gas Temperature indicator 33

Zone selected indicator 33

Engine nozzle indicator 34

Backup flight instruments..... 35

 Backup altimeter..... 35

 Backup attitude indicator 35

 Backup compass 36

 Backup airspeed indicator 36

Navigation and other..... 37

 Distance indicator 37

 Destination indicator 37

 Fuel indicator 38

 Clock 38

 Accelerometer (G-indicator)..... 39

 Oxygen pressure indicator 39

 Brake pressure indicator 40

 Cabin pressure indicator 40

 Pitch trim indicator 41

Indicator and warning system..... 42

Left indicator / warning table..... 44

 Right indicator / warning table..... 47

Master Caution alarms	49
Warning / indicator table test.....	50
Rear fuselage	51
Wings and Canards.....	51
<u>General design and Systems overview</u>	52
Aircraft overview, structural overview, fuselage, wings	53
Forward fuselage	53
Landing gear	54
Engine RM-8A / Thrust reverser	55
RM8 Engine overview.....	55
Engine specifications.....	56
Throttle overview and MAV/ settings	57
Starter system	59
Compressor stalls.....	59
Engine de-ice	60
Engine control overview.....	61
Fuel control cockpit overview	63
Thrust reverser	64
Tertiary air hatch	65
Autothrottle (AFK).....	66
Fuel system	68
Overview	68
Collection tank.....	68

Flow Distributor	69
Fuel pumps	69
Fuel system function.....	70
Start-up	70
Normal use	70
External tank.	70
Fuel system warnings	71
Fuel system cockpit overview	72
Flight control system overview	73
Control surfaces	73
Stick design	73
Differential	74
Pitch gearing	74
Roll gearing.....	75
Rudder system	76
Trim system	76
Emergency trim.....	76
Airbrakes	77
Flaps	78
High alpha warning (HAW) system	79
Landing gear, brakes and nose wheel steering	80
Landing gear lever.....	81
Emergency extension	81
Indicators	82

Wheel brakes	83
Nose wheel steering	83
Flight control system cockpit overview	84
Autopilot SA-06 (SPAK, ATT, HÖJD, Standard Turn, HAW)	86
SPAK.....	86
ATT	86
Standard Turn.....	87
HÖJD	87
Indication.....	87
Flight data unit system and FLI37 ADI	88
Main pitot system / Flight data unit	88
Accelerometer unit	88
Backup pitot system	88
FLI37 Attitude Director Indicator (ADI)	89
Course indicator ring	90
CK37 computer overview	92
Overview.....	92
Data panel	93
Master mode selector	95
Avionics overview.....	96
Head Up Display.....	96
Central indicator	97
Avionics Cockpit overview	98

HUD and CI elements	100
HUD Symbology.....	100
Take-off mode	105
LANDN NAV	106
LANDN P/O.....	107
LOW NAV low-level navigation mode	108
Weapons modes.....	108
Cental Indicator (CI) Symbology	109
Radar PS-37/A	110
Antenna elevation and scan zone range.....	111
Antenna scan width	112
Radar amplification modes	113
Radar control overview.....	114
Radar controls	115
Radar setting controls.....	116
Terrain avoidance mode	117
Passive scan mode	118
Memory mode.....	118
App-27 RWR and countermeasures systems	119
App-27 Radar Warning receiver (RWR)	119
KB countermeasures pod.....	121
U22 or U22/A ECM pods	126
Countermeasures controls overview	129

Navigation system (ADR/TILS/TERNAV/ Doppler)....	130
ADR principle.....	130
Calculation	130
Flight plan & Waypoint types.....	131
Automatic and manual initial course.....	132
Manual / automatic selected waypoint change.....	133
Navigation instruments and indicators	134
TILS	140
Indication.....	143
Landing & navigation	146
Position errors and fixing	159
Own-position fixes	160
Doppler	163
Radar altimeter	164
CK37 calculated altitude	165
Ground collision / altitude warning	166
TERNAV	169
Fuel calculation & Time keeping (Time on Target, time to waypoint) .	170
Popup points	177
Input of navigation data	179
Output of navigation data.....	189
Output TAKT	197
Output ID-NR	197
Radio systems FR 22, FR 24	198

FR 22198

FR 24201

Radio controls overview.....202

Electrical system203

 Battery.....203

 Main generator.....203

 Backup generator (ram air turbine)203

 Ground power.....204

 Circuit breakers205

Hydraulic system206

 System 1206

 System 2206

 Failure indication.....207

 Failure cases Case 1207

Lighting system (external/ internal)211

 External lights.....211

 Internal illumination212

 Illumination controls overview213

Canopy, ejection seat, and oxygen214

 Canopy214

 Canopy Jettison215

 Ejection seat215

 Oxygen216

Weapons overview	217
Weapon types	219
ARAK M/70B rockets	219
AKAN 30/55 gun pod	220
Sprängbomb 120kg M/71 General purpose bombs	221
Lysbomb 80kg M/71 Illumination bomb	222
RB-04E Anti-ship Missile	223
RB-15F Anti-ship missile	224
RB-05A air to ground / air to air missile	225
Rb-75 (AGM65A) Air to ground missile	226
BK-90 (Bombkapsel 90) Cluster munitions dispenser “Mjölner (Mjolnir)”	227
RB-24J / RB74 (AIM-9P/L) Sidewinder	228
RB 24J (AIM-9P) Sidewinder	228
RB74 (AIM-9L) Sidewinder	229
KB countermeasures dispenser pod	230
U/22 ECM pod	230
U/22A ECM pod	231
Procedures	232
Start-up procedure	233
Normal start-up (with ground power) checklist	233
Engine Start	236
Start-up without ground power	238
After engine start checklist	239

Takeoff & Landing.....	240
Take-off procedure	241
Take off methods.	242
By using the Flight Attitude Indicator	243
Take-off on short runways.	244
Visual approach.....	244
Braking.....	245
After landing	246
Shutdown procedure.....	246
Thrust reverser use	247
Instrument approach and TILS landing	249
Data input.....	251
MÅL (Reconnaissance target)	255
TID	256
TAKT	258
Navigation	261
Waypoint selection	261
Navigation display and monitoring.....	262
Navigation fixing (visual / radar / waypoint and target)	263
<u>Aerodynamic properties</u>	267
GSA (Autopilot turned off).....	268
Pitch	268
Roll and yaw	269

Normal control mode (Autopilot enabled, SPAK)	270
Pitch	270
Yaw and roll.	270
Airbrakes	270
Properties in transonic and high Mach speeds	270
High angles of attack	271
Aerobatics	272
<u>Weapons employment</u>	<u>273</u>
Weapon panel overview and weapon selection.....	275
Weapons & mode selection	279
Sighting mechanics	283
HUD & CI Element weapons symbology	285
Air to Ground	289
ARAK M/70B rocket pod / Gun pod AKAN M/55 A/G	289
General purpose bomb M/71 120 kg Sprängbomb (SB71)	297
RB 05A A/G use.....	316
RB 75 (AGM 65)	318
Illumination bomb Lysbomb (LysB) 80kg	321
RB 04E.....	325
RB 15F.....	329
BK 90 “Mjöltnir”	342
Air to Air weapons employment	351
Radar usage.....	351

Air to air Gun pods AKAN.....	352
RB 05A	354
RB 24J/RB 74.....	356
Reconnaissance.....	359
Reconnaissance Target Measurement SPA/MÅL	363
Reconnaissance target tracking SPA/SKU	366
<u>Emergency procedures</u>	<u>372</u>
<u>Appendices</u>	<u>375</u>
I. Mission Editor Settings.....	376
Mission Editor Waypoints	376
Mission editor weapon settings	378
II. Data Cartridge system.....	380
Types of cartridges	380
<u>Credits</u>	<u>383</u>

This page intentionally left blank

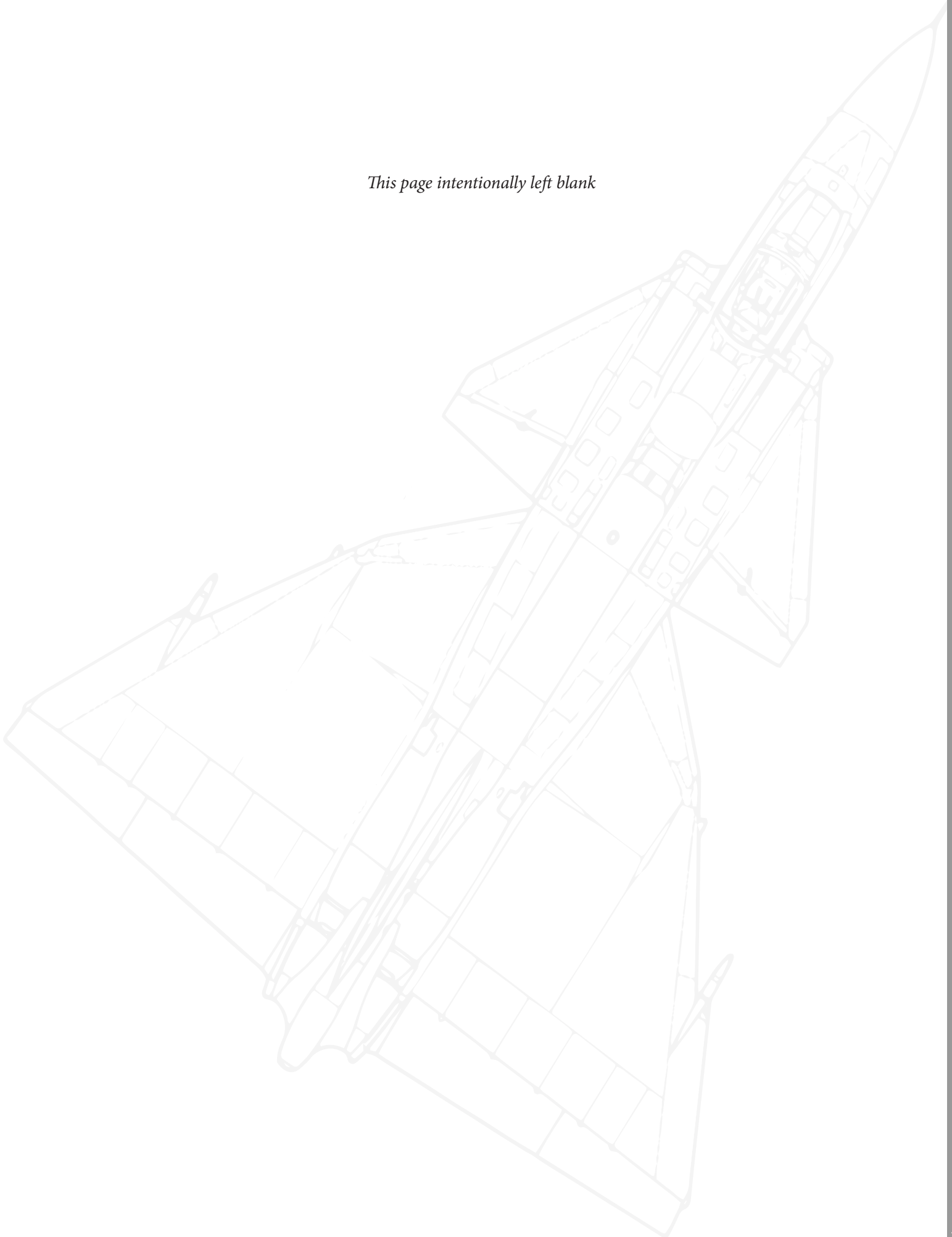

1. INTRODUCTION



The AJS-37 Viggen is a supersonic single-seat attack aircraft. The aircraft is designed with high performance in mind at very low altitudes, with good acceleration and supersonic performance. What the aircraft is perhaps most known for is the unique STOL capabilities, with the ability to take-off and land at very short distances. The aircraft is powered by a high-bypass engine, the RM8A (a heavily modified JT-8D), making it one of the most powerful single-engine aircraft of all time. The airframe is certainly of a unique design, with a canard delta planform, which provides large amounts of lift at low airspeeds.

The Viggen was developed during the 1960's and entered service in the Swedish Air Force in 1972. No other state has operated the type, although some export attempts were made. These failed due to a number of reasons.

A number of technological innovations were introduced with the type, such as a Head-up display, an automatic dead-reckoning navigation system and integrated radar system made possible by a for the time modern computer. The central computer CK37 integrates with most systems of the aircraft and facilitates everything ranging from flight data calculations, sight calculations, to controlling the radar. The PS-37/A radar is a ground mapping radar which provides a largely unfiltered view of the terrain for the purpose of navigation and targeting.

Viggen versions

The AJS-37 is an early 1990's avionics update of the AJ 37 attack variant that added avionics changes to facilitate the addition of more modern weaponry and improved systems and added functionalities.

The AJS prefix signifies the role of the aircraft in descending order of capability. "A" signifies the primary role attack (swe. Attack), the "J" for fighter (swe. Jakt) and the "S" for the added reconnaissance (swe. Spaning). While the aircraft was an early attempt at a multi-role aircraft, the fighter capability should not be overstated, with only short-range missiles and a primitive air-to-air radar mode. However, the powerful engine and manoeuvrability provides decent self-defence capabilities. The reconnaissance features are mainly for the purpose of naval reconnaissance by use of the radar for tracking ships and reporting their position, course and speed.

Other versions of the aircraft are the SH 37 (naval reconnaissance) and SF 37 (photographic reconnaissance) versions, the SK 37 two-seat trainer and the later JA 37 fighter variant. The SK37 would later receive an upgrade programme to the SK37E to incorporate dedicated electronic warfare equipment to allow training against supersonic jammers. The SH and SF models received the same avionics upgrade however could not use the same wide range of weaponry as the AJS.

Historical background

The AJS-37 Viggen is primarily designed as an attack aircraft with a focus on pre-planned targets. The tactics of the time were mainly concentrated on a single attack on a target area, with the aircraft approaching from very low altitudes (often lower than 50 m AGL) and later to withdraw at very high speed. The older AJ 37 version had bombs and rocket pods as its primary armament, along with the ability to fire the Rb-05A missile radio-guided (MCLOS) missile. Further updates during the 1980's added the AGM-65 "Maverick" (designated the Rb-75) missile. The AJS update added the BK-90 stand-off cluster munitions dispenser, originally intended for the JAS-39 "Gripen", which adds significant stand-off capabilities.



Figure 1.

Additionally, the aircraft was required to be able to engage shipping and the expected large invasion convoys. With a large coastline towards the Baltic, the Swedish Air Force had a significant focus on anti-ship duties. For this purpose, the PS/37A radar has both the functionality for setting targets for the navigation system, as well as planning and programming anti-ship missiles. The AJ 37 was initially armed with the RB-04E missile inherited from the A-32 “Lansen”. The AJS update added the necessary interfaces and computing capability to control the far more modern RB-15F missile, which can be programmed both in the manner it seeks and selects the target as well as the route the missile is going to fly.



Figure 2.

Due to the strategic doctrine of the Swedish Air Force to deploy to satellite airbases and airfields during time of war, significant short take-off and landing capabilities were required (STOL). Some of these airstrips consisted of the normal road network and some of shorter runways could be as short as 800 metres. Quick turnaround times were necessary in such a scenario. The aircraft is designed to be easily maintained and armed in such a field environment. The distinctive splinter camouflage paint scheme is intended to aid in camouflaging the aircraft at these airstrips, commonly located in the middle of the vast Swedish forests. In addition, the paint scheme aid in masking the aircraft when flying low.

General specifications

Technical data.

Crew: 1.

Length (including pitot tube): 16.3 m.

Wing span, main: 10.6 m.

Wing span, canards 5.45 m.

Height: 5.81 m.

Wing area (main wing): 46.0 m².

Wing area (canards): 6.70 m².

Wing load (at 15525kg): 3.24 kPa / 330 kgf/m².

Wheel base: 5.60 m.

Empty weight: 10659 kg.

Take-off weight (excluding armament and drop tank): 15,525 kg.

Power plant: RM8A. 65.6 kN static thrust, 115.6 kN static thrust with afterburner Zone III max.

Fuel capacity

Internal fuel: 4476 kg.

External fuel tank: 1013 kg.

Performance

Minimum turning radius on ground (centreline): 9.50 m.

Minimum turning radius on ground (wingtip) 15.45 m.

Service ceiling: 20,000 m.

Take-off speed: 200- 310 km/h.

Touch-down speed: 220- 310 km/h.

Maximum tire speed rating (max allowed speed with wheels on ground: Vi 320 km/h.

Maximum allowed airspeed, extended gear: Vi 600 km/h.

Maximum airspeed: Mach 2 or 1350 km/h indicated.

Range (Internal fuel): 1700 km.

Range (External tank): 2100 km.

Max Allowed G: 7G (6 G during peacetime). Can be exceeded but not allowed.

2. COCKPIT OVERVIEW



AJS 37
V I G G E N

General layout

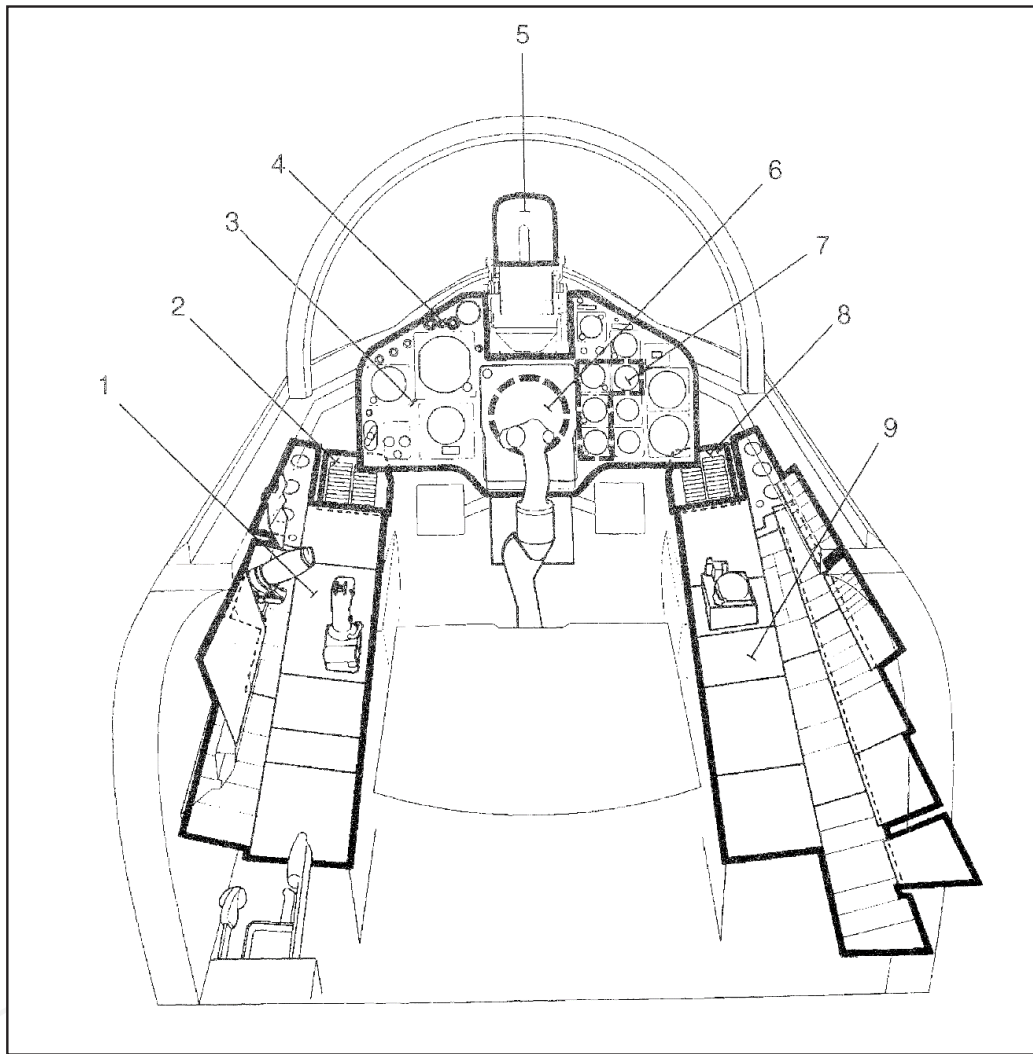

Figure 3. Cockpit layout.

1. Left side panel.
2. Left indicator / warning table.
3. Front panel.
4. Master Caution alert lights.
5. Heads up display.
6. Central indicator (CI, Radar display).
7. Backup Flight instruments.
8. Right indicator / warning table.
9. Right side panel.

Front Panel

2

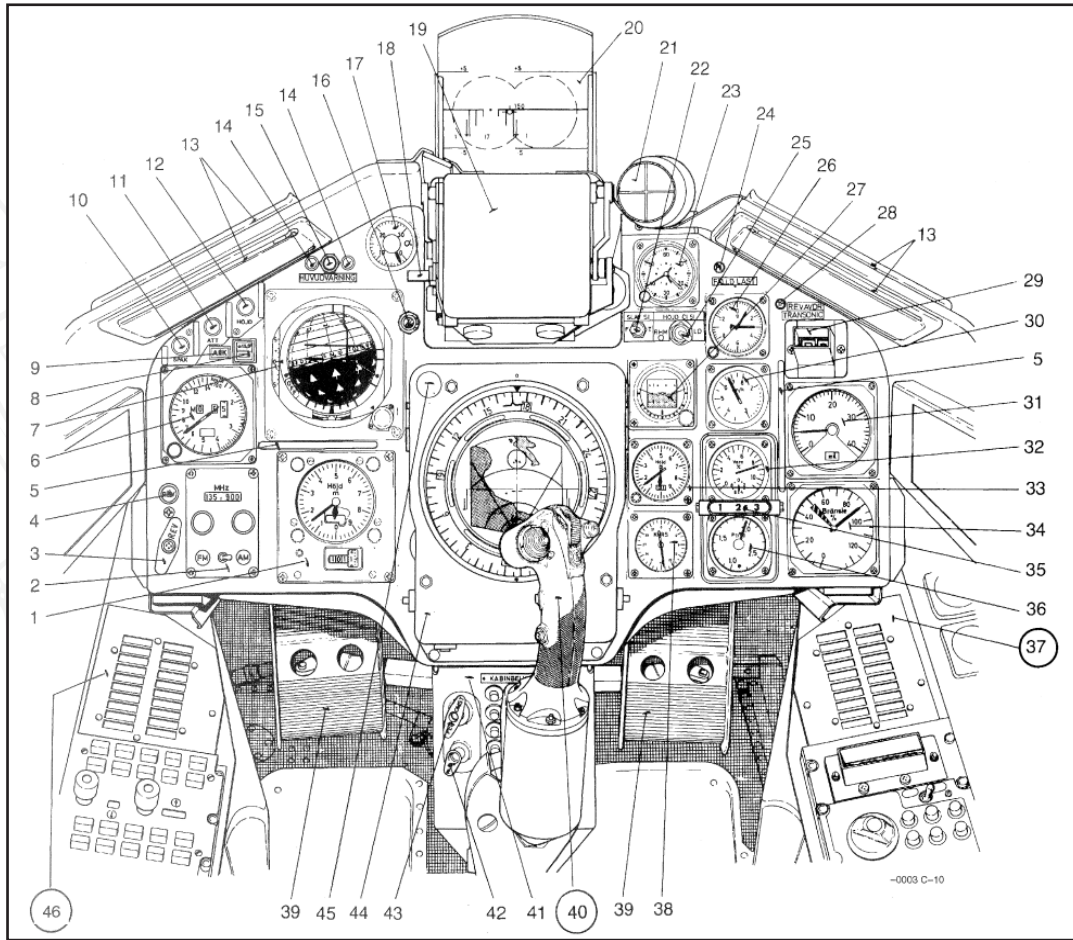

Figure 4. Front panel

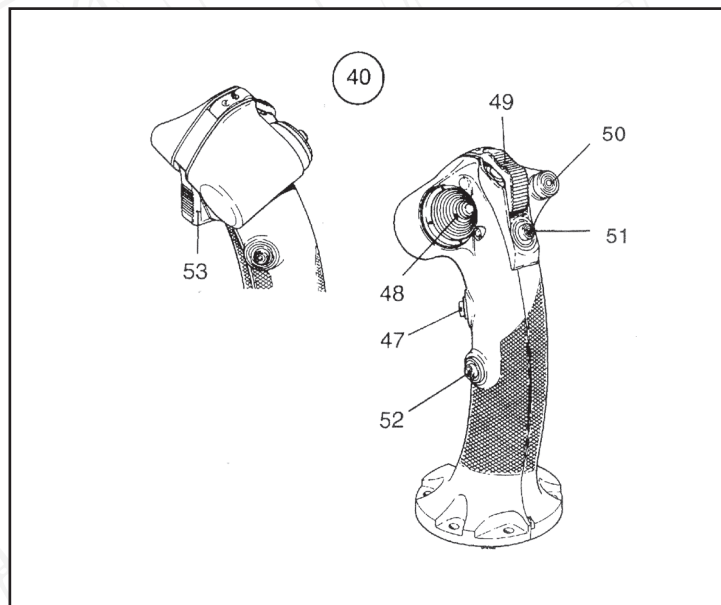

Figure 5. Control stick

1. Altimeter.
 2. Radio frequency selector.
 3. Thrust reverse handle.
 4. Reverser indicator
 5. Hand hold.
 6. Airspeed and Mach indicator
 7. Attitude director indicator (ADI, FLI37)
 8. Alpha 15.5° button (for AFK)
 9. Auto throttle mode indicator light.
 10. SPAK button and indicator
 11. ATT (attitude hold) button and indicator
 12. HÖJD (altitude hold) button and indicator
 13. Map holder
 14. Master Caution
 15. Master Caution Reset
 16. Head up display brightness
 17. Angle of Attack indicator
 18. HUD angle adjust lever
 19. HUD cover
 20. Head up display (Si)
 21. Ep-13 indicator
 22. Slave HUD switch
 23. Clock and chronometer
 24. Stores released indicator light (FÄLLD LAST)
 25. Altitude source HUD/CI (HÖJD CI/ SI switch)
 26. G-accelerometer
 27. Standby attitude indicator
 28. Reserve and transonic indicator (REV Tr)
 29. Destination indicator
 30. Standby airspeed indicator
 31. Distance indicator
 32. Engine RPM indicator
 33. Standby altimeter
 34. Fuel indicator
 35. Afterburner Zone indicator
 36. EPR (engine pressure ratio) indicator
 37. Right warning (caution) and indicator panel.
 38. Standby course indicator
 39. Rudder pedals and brakes
 40. Control stick
 41. Cockpit lighting dial
 42. Parking brake
 43. Pedal adjust
 44. Central Indicator
 45. Altitude warning light
 46. Left warning (caution) and indicator panel.
- Control Stick
47. Radio transmit/receive Fr-22
 48. Trim switch
 49. Trigger safety
 50. Autopilot disconnect
 51. Reference button (for HUD altitude reference)
 52. Event marking (no function)
 53. Trigger

Left side panel

2

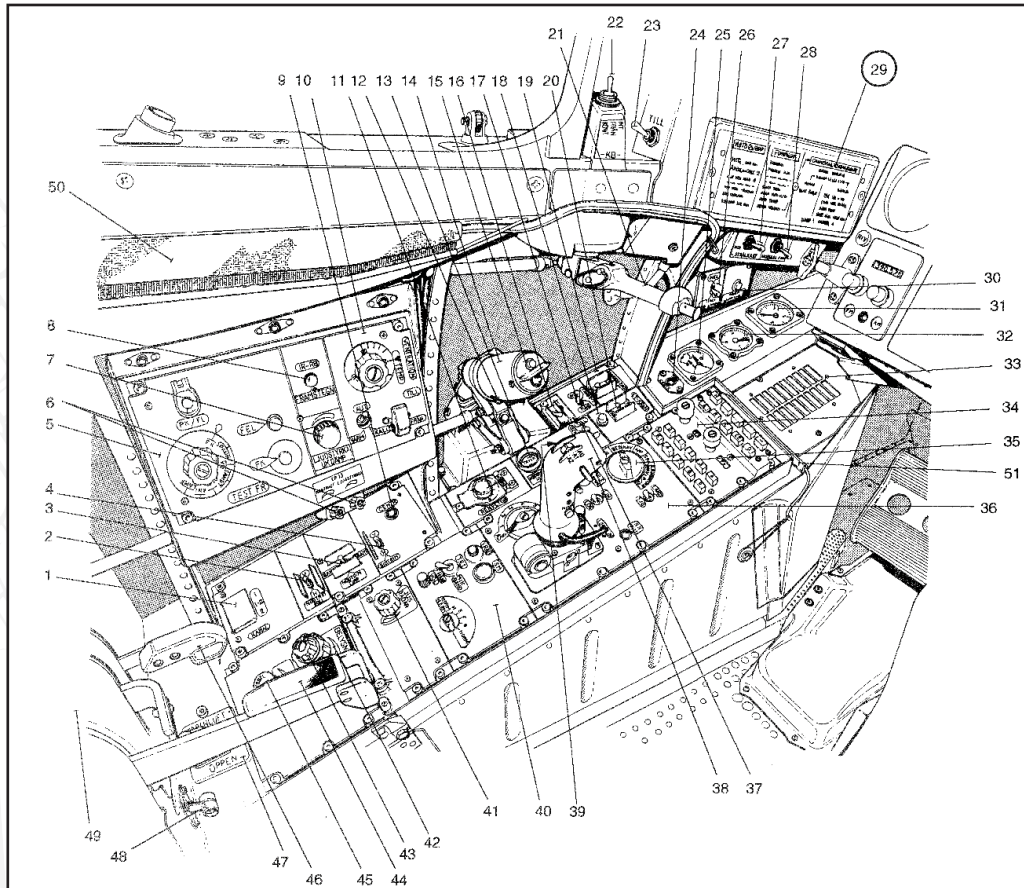

Figure 6. Cockpit left side.

- | | |
|---|---|
| 1. Autopilot channel selector | 13. Canopy Jettison. |
| 2. Emergency roll trim switch | 14. Throttle. |
| 3. Emergency pitch trim switch | 15. Countermeasures release. |
| 4. Yaw trim switch | 16. Engine Start. |
| 5. Radio panel | 17. Ignition systems. |
| 6. Ep-13 brightness and contrast dial. | 18. Low-pressure fuel valve indicator. |
| 7. Volume control Sidewinder (UK DÄMP). | 19. Main power switch |
| 8. Missile select button IR-RB FRAM-STEGR | 20. Low-pressure fuel valve switch. |
| 9. Rudder trim centred indicator. | 21. Canopy control handle |
| 10. Air conditioning panel. | 22. KB power Switch |
| 11. Autopilot yaw correction RENFLYGN. | 23. Left emergency instruction placard lighting switch. |
| 12. RB24J Un-cage. | 24. Roll trim indicator. |

25. Pitch trim indicator
26. Indicator lamps (Full/dim).
27. Landing light.
28. Emergency lighting switch.
29. Left Emergency placard.
30. Warning and indicator lights TEST.
31. Cabin pressure manometer.
32. Brake pressure manometer.
33. Left warning (caution) and indicator panel.
34. FR22 (VHF/UHF) radio control panel.
35. Master mode selector.
36. Radar control panel.
37. Generator Switch.
38. Radar control handle.
39. Engine restart switch (no visible in sketch).
40. FR 24 Backup radio panel.
41. Radar Screen illumination dial.
42. Ambient light dial.
43. Panel light dial.
44. Landing gear handle.
45. Instrument light dial.
46. Throttle friction.
47. Cabin air flow regulator.
48. Landing gear emergency extend lever.
49. Logbook and data cartridge slot
50. Arm netting for ejection seat.

Right side panel

2

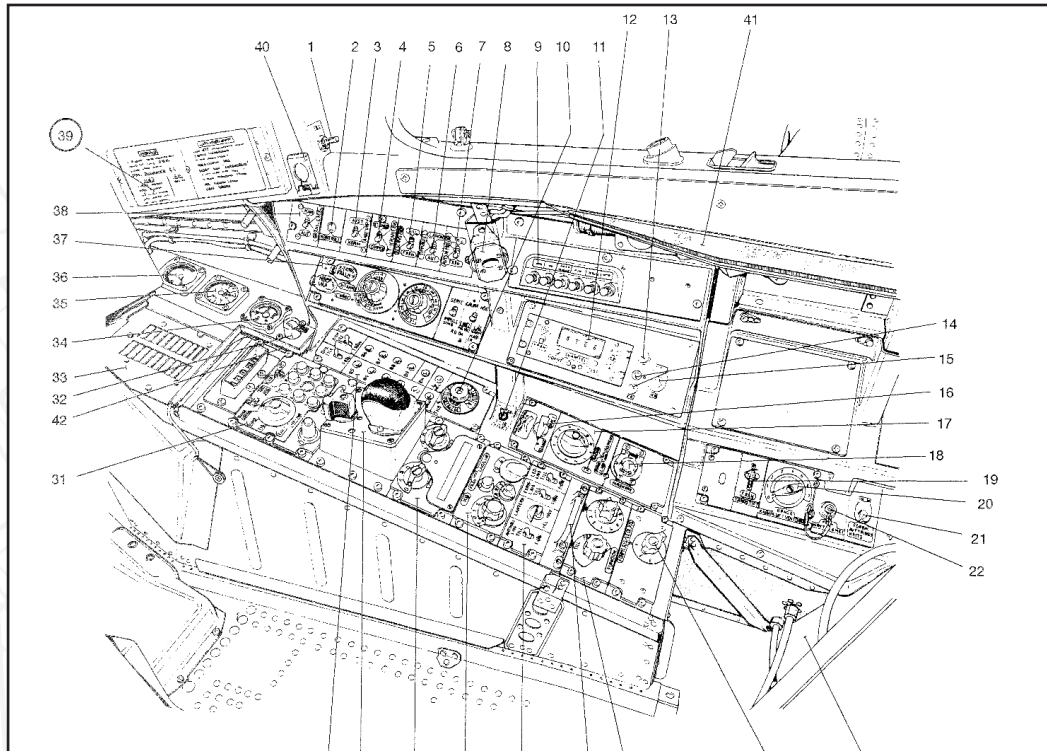

Figure 7. Right side of cockpit.

- | | |
|--|---|
| 1. Right emergency instruction placard lighting switch. | 17. Function Check panel |
| 2. Light test button | 18. Heading correction dial |
| 3. Tank pump switch | 19. Ignition switch |
| 4. Afterburner low-pressure fuel valve switch. | 20. Cabin air, cooling air external source |
| 5. Standby power generator switch | 21. Bypass stores release mechanism |
| 6. Pitch gearing switch TIPP VÄXEL | 22. Engine RPM test outlet |
| 7. Engine de-ice switch. | 23. Formation lights brightness potentiometer |
| 8. Holder for oxygen hose (for when aircraft is unoccupied) | 24. IFF control panel |
| 9. Circuit breaker panel | 25. Hand hold |
| 10. Channel selector TILS | 26. External lights control unit |
| 11. TILS group channel selector | 27. KB countermeasures pod control unit |
| 12. Transponder control panel | 28. U22 (KA) ECM pod control unit |
| 13. IFF control panel | 29. Rb05 missile steering control handle (not currently modelled) |
| 14. Function check indicator lights | 30. Navigation panel |
| 15. Countermeasures (KB) switch (Nose-wheel steering override) | 31. Data panel |
| 16. Windshield defog | 32. Oxygen valve |
| | 33. Right warning (caution) and indicator panel. |

34. Oxygen manometer
35. EGT indicator
36. Engine nozzle indicator
37. Weapons panel
38. Fuel regulator switch
39. Right Emergency instruction placard.
40. Lens holder
41. Arm netting (for ejection seat)
42. Line for arm netting
43. Gasmask storage bin (not shown)



Front instrument panel

2

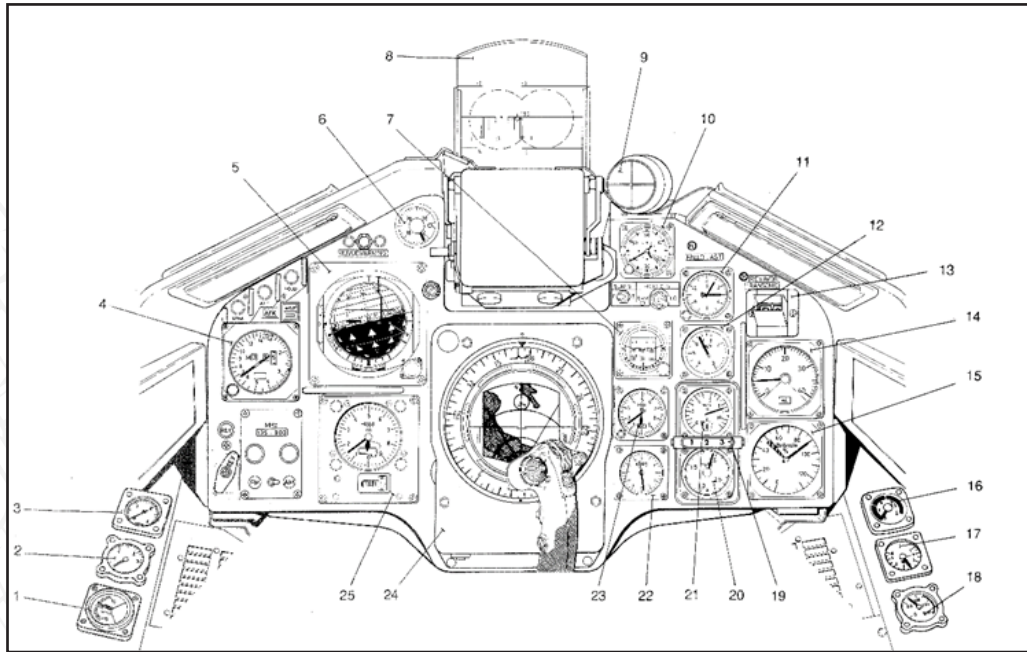

Figure 8. Front panel instruments.

- | | |
|--|---|
| 1. Pitch trim indicator | 14. Distance indicator |
| 2. Brake pressure indicator | 15. Fuel indicator |
| 3. Cabin pressure indicator | 16. Engine nozzle indicator |
| 4. Airspeed indicator | 17. Exhaust Gas Temperature (EGT) indicator |
| 5. Attitude Director indicator (ADI) | 18. Oxygen pressure indicator |
| 6. Angle of Attack indicator (α) | 19. Afterburner zone indicator |
| 7. Backup artificial horizon. | 20. Engine pressure ratio EPR indicator |
| 8. Head Up Display | 21. Engine RPM indicator |
| 9. EP-13 Indicator, Collimated sight for Rb75 (AGM-65) | 22. Backup course indicator |
| 10. Clock | 23. Backup altimeter |
| 11. Accelerometer | 24. Central Indicator (CI) |
| 12. Backup airspeed indicator | 25. Main altimeter |
| 13. Destination indicator | |

Primary Flight instruments

Airspeed indicator

Indicates current indicated airspeed in Kilometres per hour and Mach number. Below M 0.4 the Mach number is covered. A moveable index and knob are mounted, but has no function. A Fault or lack of power is indicated by the warning flag in the middle.



Figure 9. Main Airspeed Indicator. 650 km/h indicated air speed, Mach 0.58

Altimeter

Indicates barometric altitude in metres. A pressure setting dial is located on the bottom with a corresponding scale. The pressure is for hectopascal (hPa).

Rotate the pressure setting knob to change pressure setting. Pull the knob to set a standard pressure of 1013.25 hPa (29.92 inHg) indicated by the STD flag covering the pressure indicator. Pushing the knob in will return to the normal adjustable pressure.

The aircraft uses QFE (altimeter pressure setting calibrated to the airfield or ground elevation), which is used both for instrument landing and aiming calculations for the weapon system. Failure to set a correct pressure will produce minor errors in certain navigation and aiming calculations.



Figure 10. Main altimeter. 520 m altitude. Pressure set to 1011.5 hPa.

Attitude Director Indicator, ADI (FLI37)

Indicates aircraft attitude. Central “ball” rotates in 3 axes, indicating roll, pitch and course. Vertical speed indicator indicates climb or descent. Slip ball indicates sideways acceleration. Roll index indicates current bank angle.

The instrument is designed to be stable during most flight regimes, however can be fast erected in case of an error. This will however cause the initial course setting to be purged, and will result in a degraded navigation system.



Figure 11. Main Attitude Director Indicator. Straight and level flight, -3 metres per second vertical speed, heading 333, commanded heading 330

Angle of Attack (alpha, α) indicator

Indicates angle of attack (α) from 0 – 30°



Figure 12. Angle of attack indicator. Indicating 4.5° AoA (α).

Course ring and Course index

Indicates current course on the 12 o'clock position (white triangle) and current commanded course (course towards the waypoint) with the yellow course index.



Figure 13. Central indicator with Course ring. Current heading 351. Commanded heading 329.

Engine instruments

RPM indicator

Indicates revolutions per minute of the high-pressure turbine (N2, or core RPM). Large scale graded 0- 110%, smaller scale graded 10%.

2



Figure 14. RPM indicator. 94% RPM.

EPR indicator

Indicates ratio between the intake and exhaust pressure of the gas generator, EPR (Pt7/Pt2). Can be used to roughly indicate amount of thrust produced by the engine.



Figure 15. EPR indicator. EPR 1.78.

Exhaust Gas Temperature indicator

Indicates exhaust gas temperature in C°.

Instrument is powered on the DC circuit. In case of power failure, an OFF flag is displayed.



Figure 16. EGT indicator. Approximately. 440° C

Zone selected indicator

Indicates which afterburner zone is selected, that is which position the throttle is in, rather than the actual afterburner zone.



Figure 17. Afterburner indicator. Afterburner Zone 2 selected.

Engine nozzle indicator

Indicates the position of the engine nozzle, as well as the current afterburner zone the engine is in.

2



Figure 18. Engine nozzle indicator. Zone 2 afterburner open.

Backup flight instruments

The backup instruments are operated on the pitot mounted on the tailfin, and thereby are separate from the main instruments and the flight data unit.

Backup altimeter

Indicates current barometric altitude. Two needles, one graduated for 100's metres and one for 1000's of metres. Pressure setting is done by rotating the knob on the bottom left side (hPa).



Figure 19. Backup Altimeter. 1780 metres. Pressure set to 1000 hPa.

Backup attitude indicator

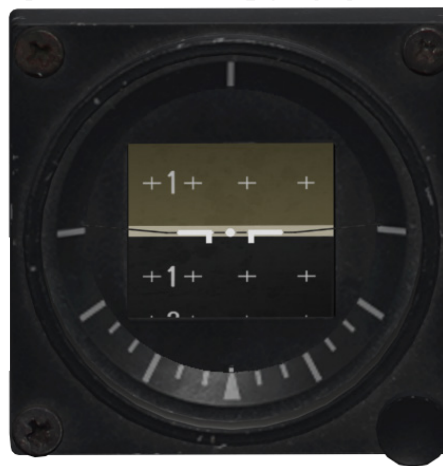

Figure 20. Backup attitude indicator.

Indicates aircraft orientation in pitch and roll by rotating a cylinder against a fixed symbol. Pitch is marked every 10° in pitch. Roll is indicated by the moving index on the bottom. Every 10° is marked on a fixed scale. 90° is also marked. The indicator has full freedom of movement in roll and between +93° and -79° in pitch.

The gyro may “tumble” during aerobatics and may require to be reset. The gyro is reset by pulling the knob for erecting it.

In case of electrical failure, the instrument will operate normally for about 3 minutes without any significant error. In case of power loss or other error, an error flag is displayed.

Backup compass

Indicates magnetic course. The compass can be fast erected by pressing a button on the bottom left. The button will be lit for the duration of the alignment (a maximum of 3 minutes).



Figure 21. Backup Compass. Indicating 020° Magnetic.

Backup airspeed indicator

Indicates airspeed between 200 – 800 km/h on a logarithmic scale.



Figure 22. Backup airspeed indicator. 560 km/h indicated airspeed.

Navigation and other

Distance indicator

Indicates the distance to the current destination (selected waypoint). Indicates 0-40 kilometres or 0-40 Swedish miles (1 Mil = 10km).

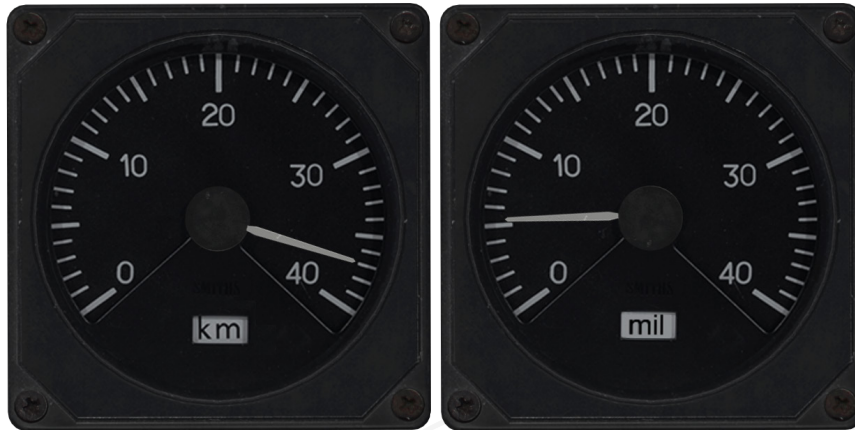

Figure 23. Distance indicator. Left picture indicating approx. 37 kilometres (or 3.7 Swedish miles). Right picture indicating 52 kilometres (or 5.2 Swedish miles) away from waypoint.

Destination indicator

Indicates current destination (selected waypoint) both in number and type.



Figure 24. Destination indicator. Left indicating waypoint 1 (B1). Centre indicating target waypoint 2 (M2). Right indicating the primary landing base (L1).

Fuel indicator

Indicates remaining fuel volume in percentage. A striped indicator (nicknamed the “tie”) indicates necessary fuel to complete the route as planned. *Please refer to the fuel calculation section for further details.*



Figure 25. Fuel indicator. 87% fuel remaining. Approx. 30% fuel required to complete flight plan with planned fuel reserve added.

Clock

Indicates current time. By default uses Local time in DCS. The clock can be changed via the knob on the lower left side (for instance if you want to set Zulu time) Note that this does not affect the aircraft computer, and will have to be changed manually. *Please refer to the TID / TIME section of the procedures chapter.*

Includes a stopwatch function button on the top right on the bezel. Press once to start stopwatch, second press to stop. The third press resets the stopwatch.



Figure 26. Clock

Accelerometer (G-indicator)

Indicates the current G-load. Graded from -2- +9 G. A needle for maximum G during the flight is included, and can be reset with a button on bottom left side of the instrument.



Figure 27. Accelerometer. 1.6 G.

Oxygen pressure indicator

Indicates the remaining pressure in the aircraft oxygen bottle. A valve mounted next to the indicator regulates oxygen flow.



Figure 28. Oxygen pressure indicator. >150 kPa/cm² remaining. Oxygen valve in the ON (TILL) position.

Brake pressure indicator

Indicates pressure in the brake accumulator tank.



Figure 29. Brake pressure indicator.

Cabin pressure indicator

Indicates current cabin pressure.



Figure 30. Cabin pressure indicator.

Pitch trim indicator

Indicates current pitch trim setting. Indicates trim setting in $\pm 10^\circ$ nose up (Nos upp) / nose down (Nos ned).



Figure 31. Pitch trim indicator. 3° nose up trim.

Indicator and warning system

2

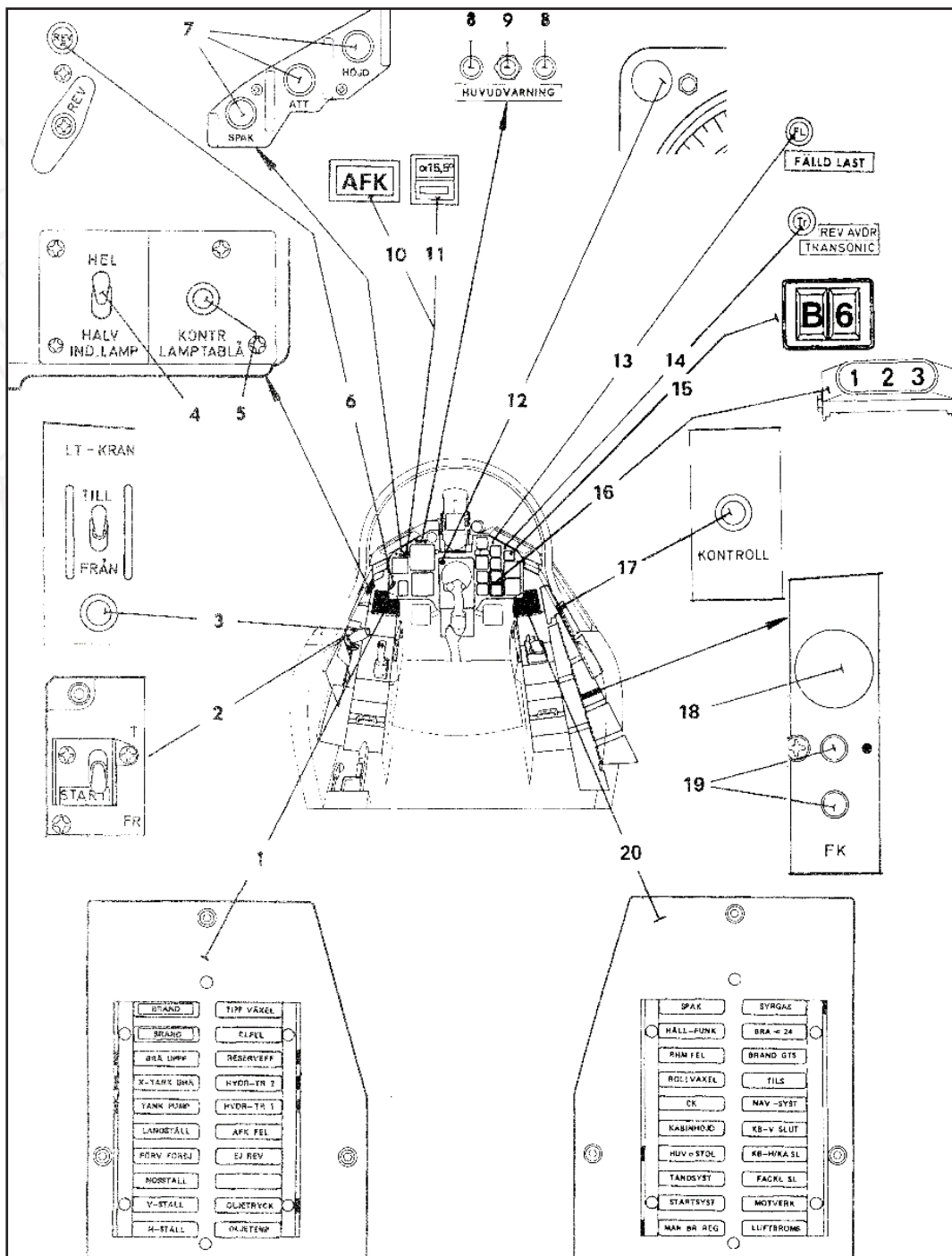
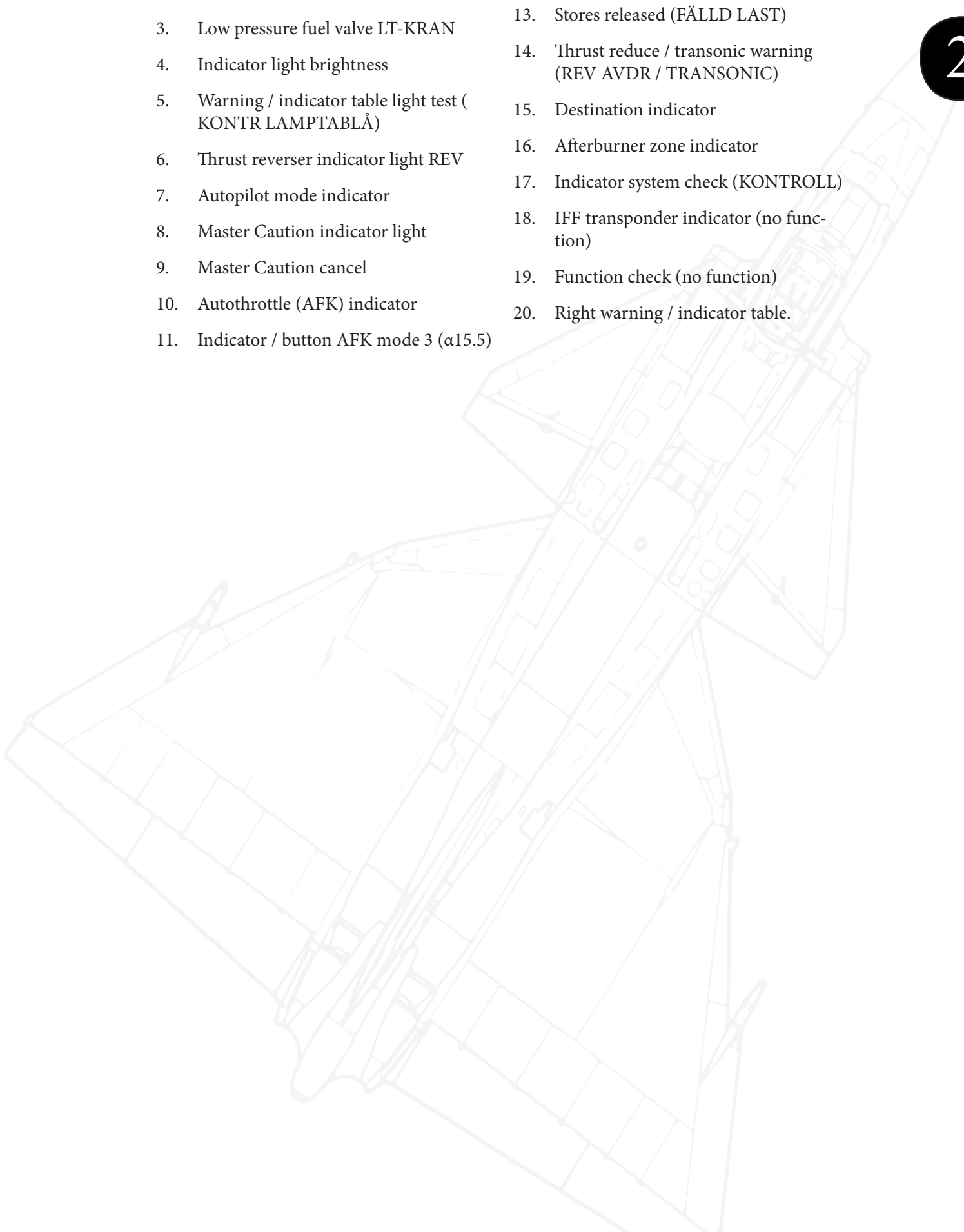

Figure 32. Indicator and warning system overview.

1. Left warning / indicator table
2. START Switch
3. Low pressure fuel valve LT-KRAN
4. Indicator light brightness
5. Warning / indicator table light test (KONTR LAMPTABLÅ)
6. Thrust reverser indicator light REV
7. Autopilot mode indicator
8. Master Caution indicator light
9. Master Caution cancel
10. Autothrottle (AFK) indicator
11. Indicator / button AFK mode 3 ($\alpha 15.5$)
12. Altitude warning light (among other uses)
13. Stores released (FÄLLD LAST)
14. Thrust reduce / transonic warning (REV AVDR / TRANSONIC)
15. Destination indicator
16. Afterburner zone indicator
17. Indicator system check (KONTROLL)
18. IFF transponder indicator (no function)
19. Function check (no function)
20. Right warning / indicator table.



Left indicator / warning table

2

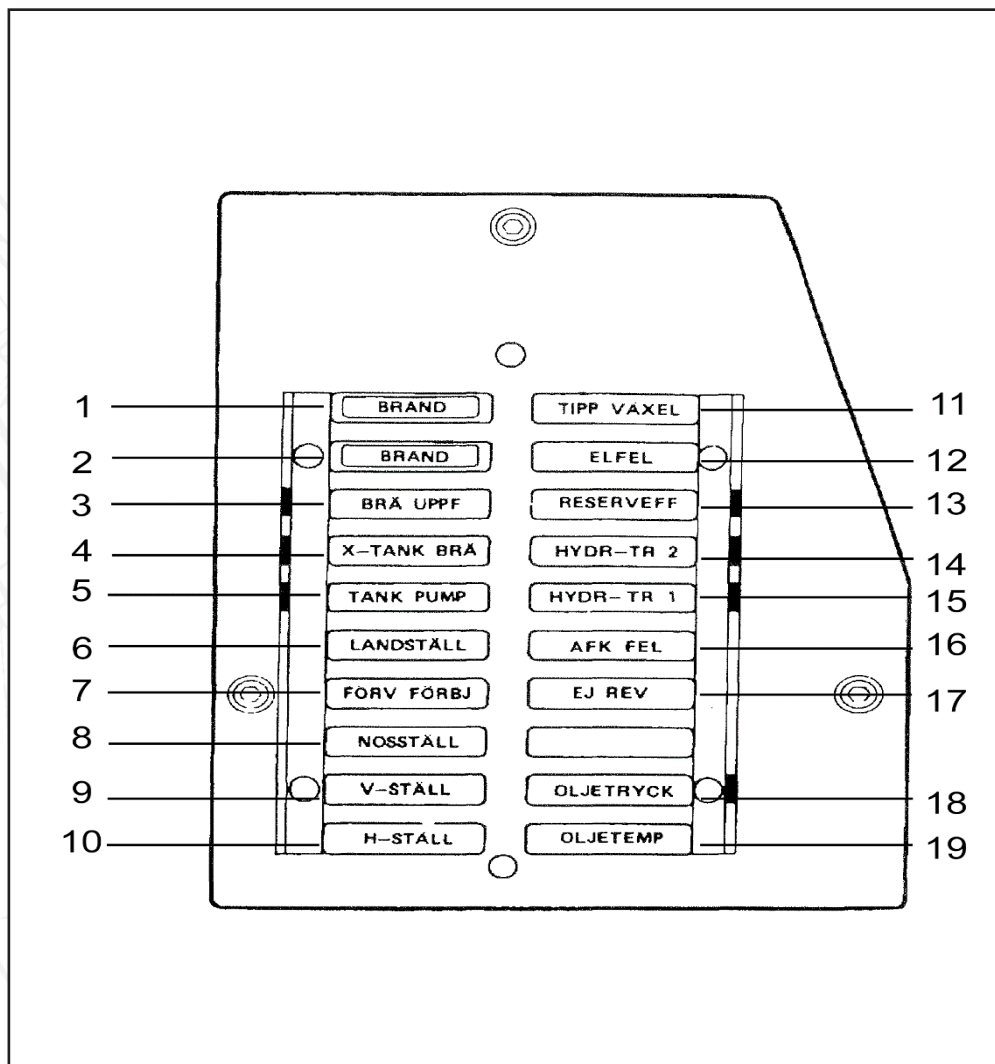

Figure 33. Right indicator and warning panel

1. Engine fire (BRAND)
 - » Indicates a fire detected in the engine bay.
2. Engine fire (BRAND)
 - » Indicates a fire detected in the engine bay.
3. Fuel distributor low pressure (BRÄ UPPF)
 - » Indicates a low pressure in the fuel distribution system, indicates a fault in the system.
4. External fuel tank warning (X-TANK BRÄ)
 - » Indicates a fault in the external fuel tank feed system. Does not indicate an empty fuel tank. Should be visible below 70% engine RPM.

5. Tank pump (TANK PUMP)
 - » Indicates a fault in tank pump system.
6. Landing gear (LANDSTÄLL)
 - » Indicates the status of the landing gear system. *Please refer to the landing gear section for further details*
7. Thrust reversal pre-select warning (FÖRV FÖRBJ)
 - » Indicates that thrust reversal is inadvisable due to possible fault.
8. Nose gear (NOSSTÄLL)
 - » Indicates that the nose landing gear is extended and locked.
9. Left landing gear (V-STÄLL)
 - » Indicates that the left landing gear is extended and locked.
10. Right landing gear (H-STÄLL)
 - » Indicates that the right landing gear is extended and locked.
11. Pitch gearing (TIPPVÄXEL)
 - » Indicates that the pitch gearing is not in the correct mode based on current airspeed, likely due to system failure, or that the system has been set to the Landing mode (LANDN) via the Pitch Gearing switch (TIPP VÄXEL)
12. Electrical failure (ELFEL)
 - » Indicates a failure in the electrical system, such as a generator failure. If the aircraft is started on battery, the indication will disappear when the generator is powering the aircraft.
13. Backup hydraulics or backup generator failure. (RESERVEFF)
 - » Indicates that:
 - The backup generator is deployed manually while airborne **without** a main generator failure.
 - A main generator failure with the backup generator **not** deployed.
 - Backup generator **not** deployed and main landing gear extended during take-off.
 - Backup hydraulic pump operating while there is still pressure in hydraulic system 2.
 - Backup hydraulic pump **not** operating while **no** pressure in hydraulic system 2.
 - Backup generator **not** deployed, landing gear retracted and backup generator switch (RESERVSTRÖM) in mode ON (TILL).
 - Backup generator deployed but not delivering power.
14. Hydraulic system 2 pressure (HYDR-TR 2)
 - » Indicates low pressure in hydraulic system (likely leak or pump failure)
15. Hydraulic system 1 pressure (HYDR-TR 1)
 - » Indicates low pressure in hydraulic system (likely leak or pump failure)

16. Autothrottle failure (AFK FEL)

- » Indicates that the autothrottle has failed (flashing light along with a master caution) or that the autothrottle is automatically disengaged on right main landing gear is depressed on landing or manually by the AFK disconnect button.

17. Thrust reverser failure (EJ REV)

- » Indicates that the thrust reverser system is inoperable or otherwise prohibited.

18. Oil pressure warning (OLJETRYCK)

- » Indicates a low pressure in the engine lubrication system

19. Oil temperature warning (OLJETEMP)

- » Indicates high temperature in the engine lubrication system.



Right indicator / warning table

2

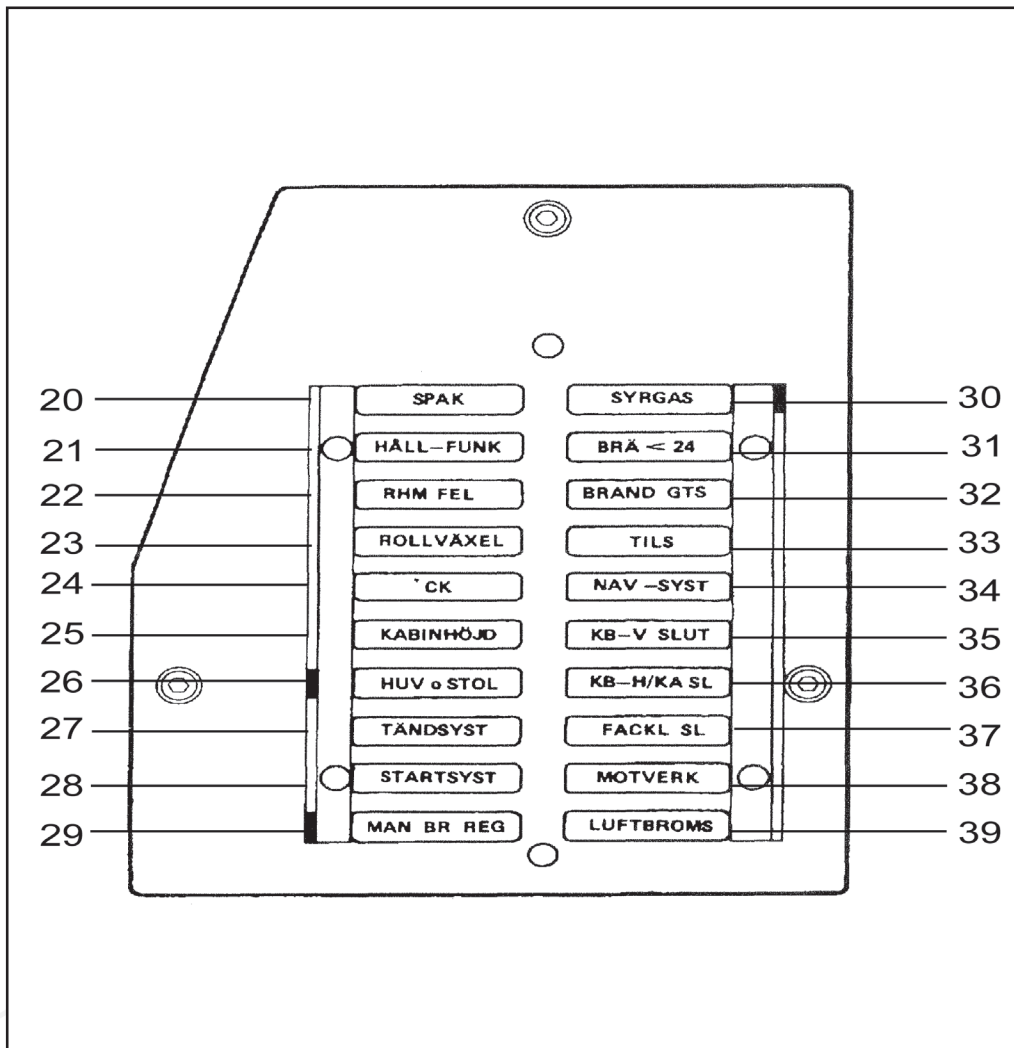

Figure 34. Left indicator and warning panel.

20. SPAK autopilot failure (SPAK)
 - » Indicates a failure of the autopilot damper systems or that the mode has been disengaged without pilot input.
21. Autopilot hold function failure (HÅLL-FUNK)
 - » Indicates a failure in the autopilot attitude / altitude hold systems or that for some reason the modes have been disengaged without pilot input or that the parameters for the autopilot modes are not fulfilled.
22. Radar altimeter failure (RHM FEL)
 - » Indicates a failure of the radar altimeter system.
23. Roll gearing (ROLL VÄXEL)
 - » Indicates a failure of the roll gearing system.
24. Computer error (CK)
 - » Indicates a failure of the main computer CK37.
25. Cabin pressure (KABINHÖJD)
 - » Indicates low cabin pressure.

26. Ejection seat and canopy (HUV o STOL)
 - » Indicates that the seat is not armed, canopy unlocked when closed, or that the circuit breaker for the ejection system is off (UTSKJKRETS).
27. Ignition system (TÄNDSYST)
 - » Indicates ignition system is active.
28. Starter system (STARTSYST)
 - » Indicates that the engine starter system is active.
29. Manual fuel regulator (MAN BR REG)
 - » Indicates that the manual fuel regulator is in Manual mode (MAN).
30. Oxygen (SYRGAS)
 - » Indicates that the oxygen valve is off or pressure in the oxygen bottle is low.
31. Low fuel warning (BRÄ < 24)
 - » Indicates fuel amount is below 24%.
32. Gas turbine starter fire (BRAND GTS)
 - » Indicates a fire in the gas turbine starter system.
33. TILS indicator (TILS)
 - » Indicates the status of the TILS landing system.
34. Navigation system (NAV-SYST)
 - » Indicates a failure in the navigation system.
35. Left countermeasures pod empty (KB-V SLUT)
 - » Indicates that the left countermeasures pod is empty.
36. Right countermeasures pod empty / ECM pod failure (KB-H/KA SL).
 - » Indicates that the right countermeasures pod is empty and/or an ECM pod failure.
37. Flares empty (FACKL SL)
 - » Indicates that the flares in the countermeasures pod are empty.
38. Countermeasures system (MOTVERK)
 - » Indicates the status of the countermeasures and radar warning system.
39. Airbrakes (LUFTBROMS)
 - » Indicates that the airbrakes are extended.

Master Caution alarms

Several of the systems may cause a master caution alarm. This is indicated by an audio tone as well as the two master caution lights flashing alternately. To cancel the master caution alarm, press the button between the two lights.

2



Figure 35. Master caution.

Warning / indicator table test

The master caution indicator and alarm sound and all the lamps in the warning / indicator tables are lit by pressing the warning / indicator table light test button (KONTR LAMPT-ABLÅ) mounted on the left side of the glare shield. Additionally the following lights are tested via the same button:

- Low pressure fuel valve (LT-kran) warning light.
- Thrust reverser indicator light.
- Autopilot indicator lights (SPAK, ATT, and HÖJD).
- Autothrottle AFK indicator light.
- Autothrottle mode 3 (α 15.5) indicator light.
- Thrust reduction / transonic indicator light.
- Stores released (FÄLLD LAST) indicator light.

Some of the lights are marked with white markers next to them. This is to indicate which lights should be displayed after the warning / indicator table light test button is released.

Indicator system test

The indicator system test (KONTROLL) mounted on the right vertical panel is used to test the altitude warning light as well as the following systems.

- Fire warning.
- Fuel indicator.
- High alpha warning.
- Landing gear indicator.
- Radar altimeter.

Please refer to the procedures section for further details.



Rear fuselage

The rear fuselage is dominated by the engine and fuel tanks. Behind the engine is the ejector assembly. Within this assembly there is the tertiary air inlet slits, which both add a bit of extra thrust at lower airspeeds and serves as an exhaust nozzle during thrust reversal. The slits are covered by the tertiary air hatch at high speeds. The reverser assembly consists of three titanium flaps which close and direct the thrust forwards and slightly downwards through the slits.

The rear fuselage features a bulge along the spine, which was added during prototyping to alleviate issues during transonic flight, to reduce drag according to the area-rule.

Wings and Canards

The wings are perhaps the most distinguishing and recognisable feature of the aircraft. The main wings are of a honeycomb construction and contains the wing fuel tanks, the elevons and weapons stations for stores. The hardpoints are merged on stakes with the servos for the wing surfaces.

While the wings had issues with structural weaknesses in the early airframes, with fractures occurring in the wing roots, this was addressed by significantly thickening the wing structure.

The canards are perhaps the most interesting addition to the aircraft from an aerodynamic point of view, in which it creates a system of vortices creating lift as opposed to a conventional wing design. The rear of the canards contain the flaps which will automatically extend when the undercarriage is extended. Due to certain weapons configuration and their aerodynamic impact, the flaps can be raised to an upwards angle of either 4 or 7 degrees to counteract these effects.

3. GENERAL DESIGN AND SYSTEMS OVERVIEW



Aircraft overview, structural overview, fuselage, wings

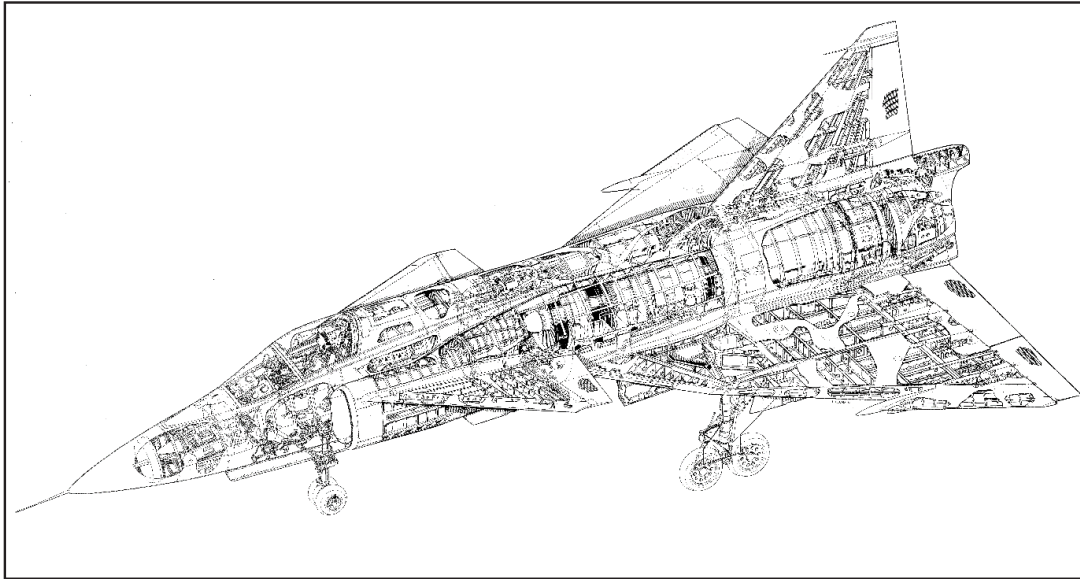

Figure 36. AJS 37 structural overview.

Forward fuselage

The forward fuselage contains the cockpit, radar and the majority of the aircraft avionic systems. The PS/37A radar is housed within the nosecone. The cockpit is situated between the two engine intakes. Note that the engine intakes have narrow slits on the bottom to allow a smoother airflow during flight at high angles of attack. An air intake for the cooling system for the electronics, oil and cabin air is situated at the belly, and four exhausts are situated just behind the canopy.

The aircraft is designed for ease of maintenance and quick access to the electronics bays. The right side has access panels for the ground crew to prepare the aircraft for flight and setting weapons parameters without having to kneel.



Figure 37. Canards and flaps.

Landing gear

Due to the requirement of being able to operate on short roadway airstrips, the landing gear of the Viggen is somewhat unique. With the low landing speed required to land on such a short distance, the vertical velocity is higher than seen in conventional landing with a flare. In order to lessen the impact and strengthen the undercarriage, the rear landing gear consists of two wheels on each axis arranged on a bogie. As the aircraft touches down, the bogie rotates slightly and removes a significant portion of the impact on hard landings. The bogies additionally provide longitudinal stability during landing and thrust reversal.

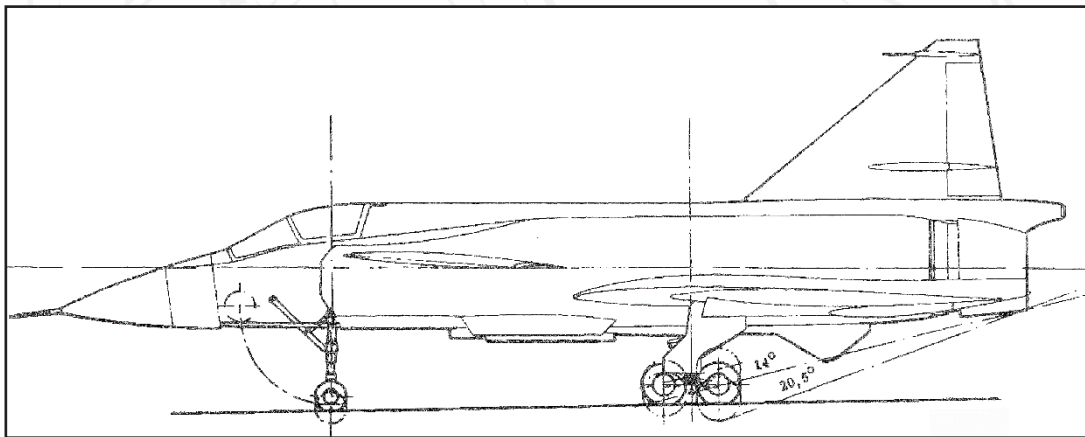

Figure 38. Figure 40 Landing gear and rotation limits in degrees.

Engine RM-8A / Thrust reverser

RM8 Engine overview

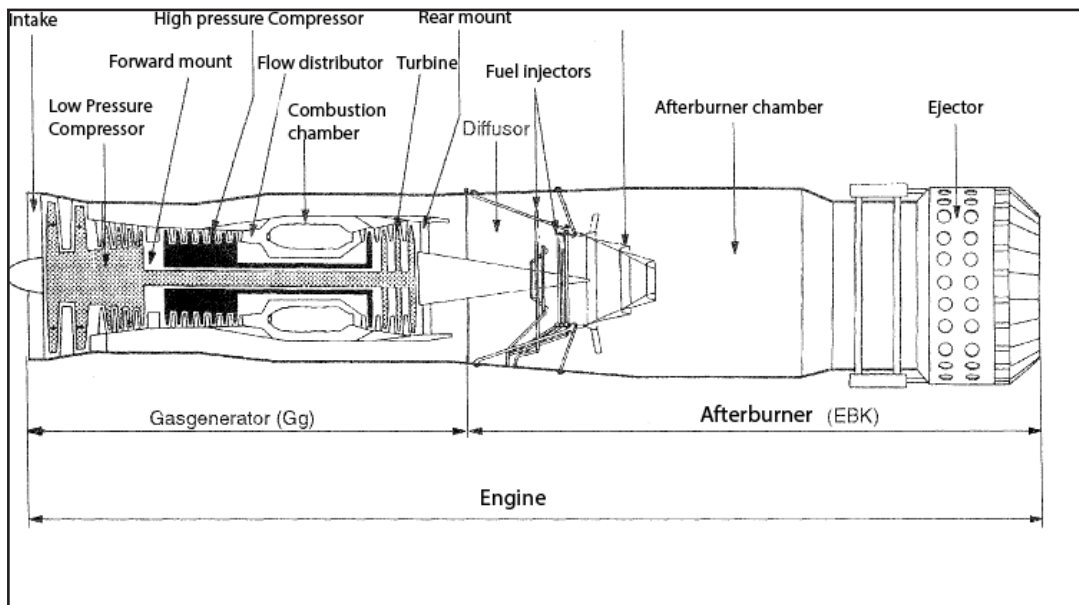

Figure 39. RM-8A Engine.

The RM-8A (Swe: ReaktionsMotor 8A) is a high-bypass (for a fighter engine) axial-compressor turbofan engine. The engine is a modified P&W JT8D-22 airliner engine, with changes to the gas generator and more importantly the addition of an afterburner.

The relatively high bypass ratio (for a military fighter) of the engine allows greater fuel efficiency as well as maintaining a higher level of thrust compared to a low or no-bypass engine. The relatively high portion of air that passes through the fan stage, but does not go through the compressor and combustion chamber, later merges with the compressed air at the afterburner.

Engine specifications

Rotation: Clockwise

Diameter: 1,350mm

Length with afterburner, room temperature: 6,170 mm

Length, gas generator: 3,420 mm

Overall pressure ratio: 16.5:1

Bypass ratio: 0.97:1

Thrust Military power (Max dry): 65.6 kN static thrust,

Thrust Max afterburner Zone III: 115.6 kN static thrust

Weight, total: 2095 kg.

Thrust to weight ratio: 5.4:1

Max Exhaust Gas Temperature: 600 °C

Fan stages: 2

Low-pressure compressor stages: 4

High pressure compressor stages: 7

Combustion chambers: 9

Thrust setting	Core RPM (100% = 12278 rpm)		Thrust kN	Specific fuel consumption kg/s	Nominal exhaust temperature C	Pt7/Pt2
	RPM	%				
Full (Zone 3) Afterburner	11950	97.3	115.6	8.253	600	2.06
Full Military	11850	96.5	65.6	1.167	570	2.04
In-flight Idle	9080	74	14.3	0.267	380	1.21
Ground Idle	7250	59	3.2	0.122	280	1.02

Values will vary with pressure and ambient temperature and airspeed.

Throttle overview and MAV/ settings



Figure 40. Throttle.

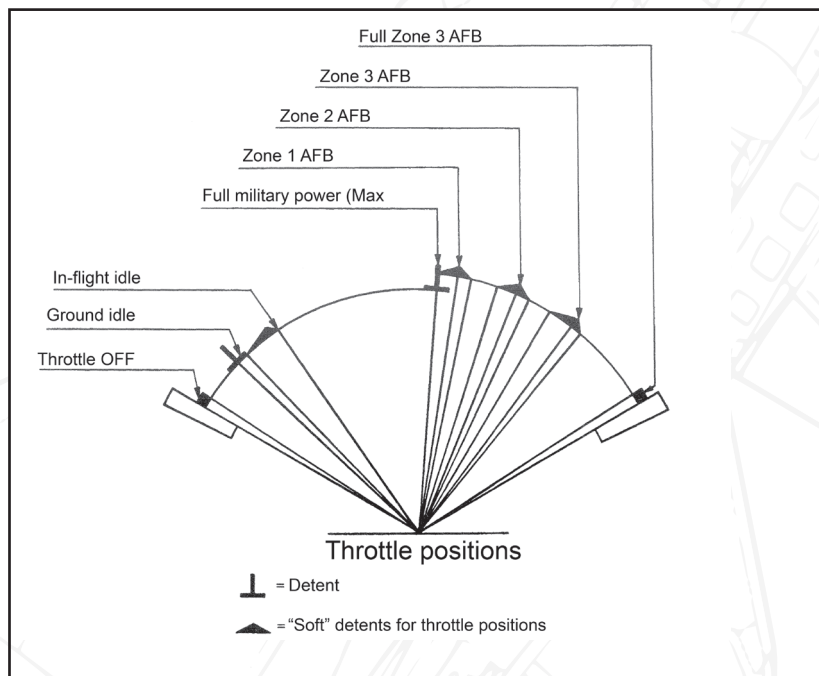

Figure 41. Throttle positions.

The Viggen throttle is divided into 5 main zones.

- OFF: Throttle is behind a detent, high pressure fuel valve is off. In order to advance the throttle, a small catch on the left side of the handle has to be lifted.
- Ground idle. Lowest possible RPM, High pressure fuel valve on.
- In-flight idle. Low RPM setting, but high enough to avoid to an excessively long spool up time while airborne.
- In-flight idle to Military power (max dry thrust).
- Afterburner zones 1, 2, and 3.

The afterburner has three distinct zones, 1, 2, and 3. Each zone has a small amount of movement and thrust regulation within it, while still remaining distinct. The third zone has the highest amount of throttle travel to allow smaller adjustments of thrust. The chosen afterburner zone is indicated on the right side of the instrument panel. The actual nozzle position is indicated by the nozzle indicator on the right front side panel.

3



Figure 42. Afterburner zone indicator. Zone 2 selected.



Figure 43. Engine nozzle indicator. Zone 2 afterburner open.

Starter system

The engine is started by a Gas Turbine Starter unit (GTS). Essentially a small jet engine, it runs on the main fuel source. Once it reaches the correct RPM, the GTS engages onto the engine and accelerates it until it reaches self-sustaining RPM.

The GTS is itself started by a small electrical motor, which accelerates the GTS unit to its lowest sustainable RPM. The aircraft can be started either via the battery, or by use of the ground power unit. The battery can sustain about three start up attempts before being drained.

The GTS does not provide any power on its own and can only be started via the automatic start-up sequence. The whole sequence is initiated via the starter (START) switch or automatically in case of an in-flight start below a certain engine rpm where the GTS is necessary.

Fire in the GTS is indicated by the Starter unit fire (GTS BRAND) warning light on the right indicator / warning table.

Compressor stalls

The engine is susceptible to compressor stalls and surges during excessively rapid throttle movements, flight at high angles of attack and high altitude flight, or a combination thereof. A compressor stall is a disruption of airflow in the engine, often caused by a change in pressure or turbulent air into the engine. A compressor stall is often detected by a loud bang and/ or a temporary reduction in thrust.

A compressor surge is a more extensive form of a stall in which there is a complete disruption of airflow in the engine which can even lead to air and combusting fuel being propelled forwards out of the inlets! A surge may lead to either a flameout of the combustion chambers or even a catastrophic failure of the engine.

Please note the operating parameters and guidelines in the procedures section on how to avoid compressor surges. Emergency placards for recommended actions are mounted on the left side of the glare shield.

Engine de-ice

In icing conditions the inlet can be heated to increase the temperature of the intake air in order to avoid ice build-up. The heating system is controlled by the engine de-ice switch (AVISN MOTOR). Due to engine air being tapped for this system, a slight thrust reduction of 1.5 – 3.5% can be expected.



Figure 44. Engine de-ice

1. Landing gear lever
2. AFK control lever
3. Low pressure fuel valve switch, LT-KRAN
4. Generator (GENERATOR) switch
5. Engine restart (ÅTERSTART)
6. Starter switch (START)
7. Ignition system (TÄNDSYSTEM)
8. Main power switch (HUVUDSTRÖM)
9. Throttle
10. AFK fast disconnect
11. Left indicator / warning table.
12. Thrust reverser handle
13. Thrust reverser indicator (REV)
14. Master Caution lights (HUVUDVARNING)
15. Thrust reduction / Transonic indicator light (REV AVDR /TRANSONIC)
16. RPM indicator
17. Afterburner zone indicator
18. Engine Pressure Ratio (EPR) indicator
19. Right indicator / warning table
20. Nozzle position indicator
21. Exhaust Gas Temperature indicator
22. Manual Fuel regulator mode switch (BRÄNSLEREGL)
23. Indicator system check (KONTROLL)
24. Engine De-ice (AVISN MOTOR)
25. Igniter (TÄNDSTIFT)
26. AFK mode 3 α 15.5 selector
27. AFK indicator light
28. Afterburner fuel valve (LT-KRAN EBK)
29. Circuit breaker for engine start system (MOTOR)

Fuel control cockpit overview

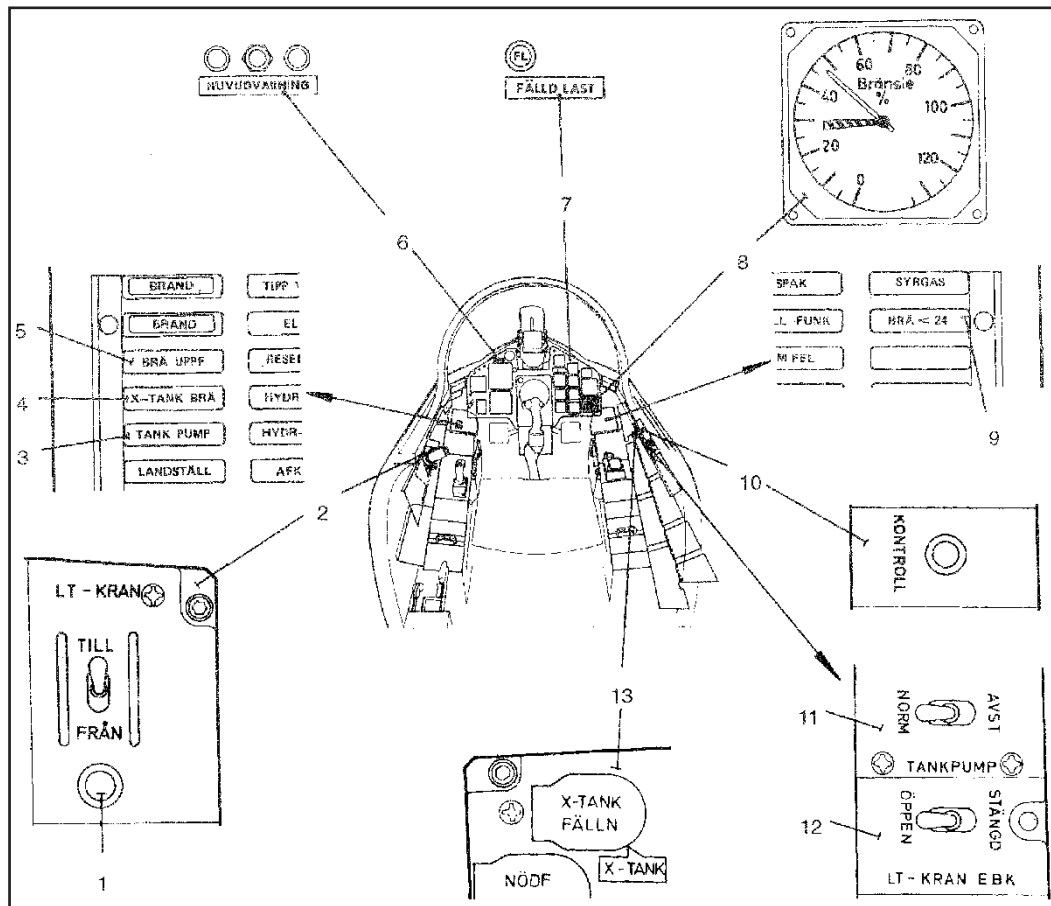

Figure 46. Fuel control overview.

- | | |
|---|--|
| 1. Low pressure fuel valve indicator light | 7. Indicator light Stores Released (FÄLLD LAST) |
| 2. Low pressure fuel valve switch (LT-KRAN) | 8. Fuel indicator |
| 3. Tank pump Indicator light (TANK-PUMP) | 9. Indicator light Fuel < 24% (BRÄ <24) |
| 4. Indicator light external tank failure (X-TANK BRÄ) | 10. Indicator system check (KONTROLL) |
| 5. Indicator light Fuel low pressure warning (BRÄ UPPF) | 11. Tank pump switch (TANKPUMP) |
| 6. Master caution lights | 12. Afterburner fuel valve (LT-KRAN EBK) |
| | 13. External fuel tank release (under plastic cover) |

Thrust reverser

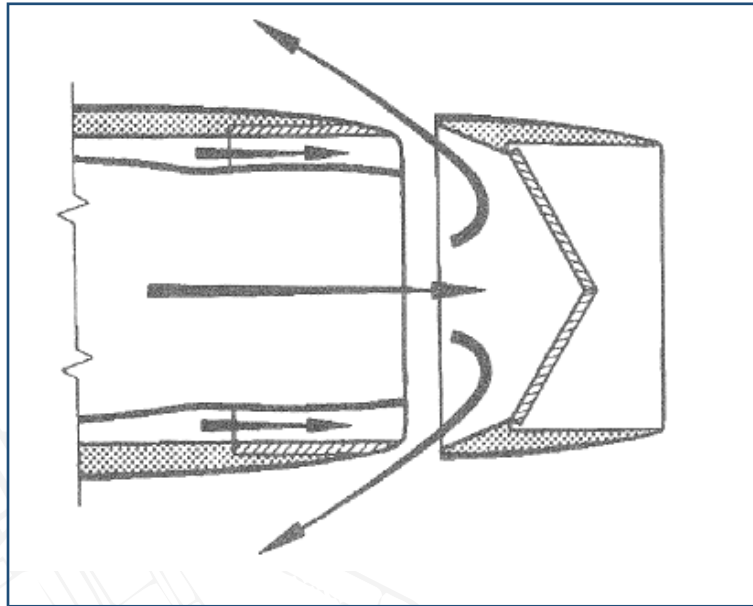

Figure 47. Thrust reverser system (seen from above).

The thrust reverser is used during landing to direct the thrust forward to significantly shorten the landing distance. The reverser claps close the ejector and instead direct the exhaust forwards and slightly downwards through three slits in the ejector assembly.

The thrust reverser flaps will close when the right main landing gear is depressed if reversal is pre-selected. To avoid reversing in an unstable attitude, the reverser flaps will open again after 1 second unless the nose landing gear is compressed. The reverser system will reengage when the nose gear is compressed again. In order to achieve the shortest distance possible, the nose gear should touch the ground as soon as possible after touch down with the main landing gear.

The reversal system is engaged by pulling the reverser handle REV on the left side of the front panel. Pulling the handle while airborne will pre-select reversal.

When using the thrust reverser the throttle function as normally. Due to the thrust being directed partially downwards behind main undercarriage, effectively turning into a fulcrum, the nose will be pressed against the ground. This is to maintain stability, but requires the pilot to pull back on the control stick proportional to the amount of thrust used. In other words, the further the throttle is moved forwards, the further back the control stick is needed to be pulled in order to lessen the pressure on the nose-gear. Failure to do so may lead to increased instability as the weight on the rear wheels are reduced during very heavy braking.

Note: Afterburner cannot not be used during thrust reversal as this would cause extensive damage to the aircraft. The fuel flow to the afterburner is inhibited during reversal, disabling the afterburner while the reverser is in use.

Please read the “thrust reverser use” section of the procedures section for further explanation.

Tertiary air hatch

The tertiary air hatch provides a small amount of extra thrust at low altitudes by acting as somewhat of a secondary bypass system. Additional air is pulled through the slits and join the compressed air stream. At higher airspeeds this slit is closed by the tertiary air hatch. The hatch opens and closes in about 5 seconds.

The hatch is closed if the following requirements are met;

- » Airspeed is $>$ Mach 0.65
- » Landing gear lever position IN
- » Throttle $<$ zone II afterburner

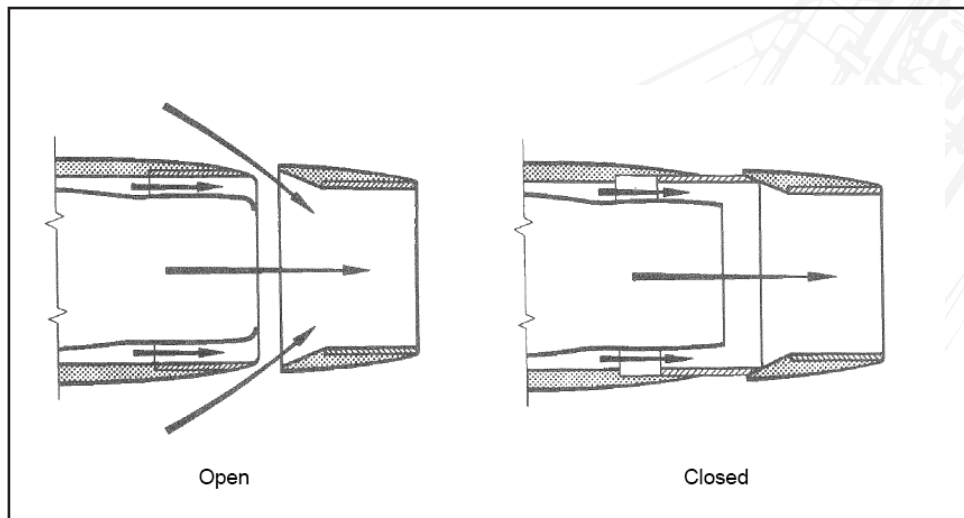

Figure 48. Tertiary air hatch. Open / Closed (seen from above).

Autothrottle (AFK)

In order to shorten the landing distance and reduce pilot workload during high-stress landings, the aircraft is equipped with an automatic throttle system called AFK (swe. Automatisk Fart Kontroll). During use the aircraft will automatically move the throttle and continually adjust thrust to maintain the given reference airspeed. AFK use is indicated by the AFK light on the front panel (top left) and AFK mode 3 indicated by an illuminated button “α 15.5”. The AFK cannot engage the afterburner. If the afterburner is engaged by the pilot, the AFK is automatically disengaged.

To increase available thrust if necessary, when the landing gear is deployed and AFK is engaged, a signal is sent to the fuel regulator of the gas generator resulting in a 1.5 % increase in RPM beyond the normal military power (max dry thrust), yielding a thrust output increase of about 3.5%. The increase in max RPM is removed once AFK is disengaged or landing gear is retracted.

Manual engage / disengage

The AFK is manually engaged / disengaged by moving the AFK control lever next to the landing gear handle (far left in cockpit). Moving the lever to the ON position will engage the AFK.

The AFK can also be quickly disengaged by pressing the AFK fast disconnect button on the throttle. This will cause the AFK FEL indicator light on the left indicator panel to be lit with a solid glow.

Note that this button is also used as an IR missile fast select. Please read the armaments section regarding this use.

Automatic disengage

The AFK is automatically disengaged when the right main landing gear is compressed (touches down)

Note: The AFK FEL (AFK ERROR) is reset after the AFK lever is set to OFF.



Figure 49. AFK lever and indicator.

The AFK has three main modes;

Mode 1

Conditions: Landing gear IN, AFK lever ON

The AFK will adjust the thrust to maintain 550 km/h indicated airspeed.

This mode can be used beyond the landing phase to maintain a slower cruise airspeed. Combined with the Standard Turn mode of the autopilot, the plane will loiter.

Mode 2

Conditions: Landing gear OUT, AFK lever ON

The AFK will adjust thrust to maintain an airspeed corresponding to an angle of attack (AoA or α) 12° at 1 G equilibrium.

Mode 3

Condition: Landing gear OUT, AFK lever ON, $\alpha 15.5$ button ON.

AFK will adjust thrust to maintain an airspeed corresponding to an angle of attack of 15.5 at 1 G equilibrium. This is used when the shortest landing distance is required.

Note: Mode 3 can only be used with a very light aircraft (Fuel <40%) due to the high thrust to weight ratio required.

Fuel system

Overview

Fuel: Flygfotoegen 75 (NATO F-34, JP-8) 0.81 kg/L

Internal fuel 5525 L = 103.0 % ± 5%

Internal + External drop tank 1250 L = 127.5% ± 5%.

The fuel gauge indicates the remaining fuel in percent.

The aircraft is fitted with 8 internal fuel tanks, and it is possible to attach an external drop tank on the centre fuselage pylon. The system consists of a central collection tank and the remaining tanks are designated as feeding tanks. The tanks are pressurised.

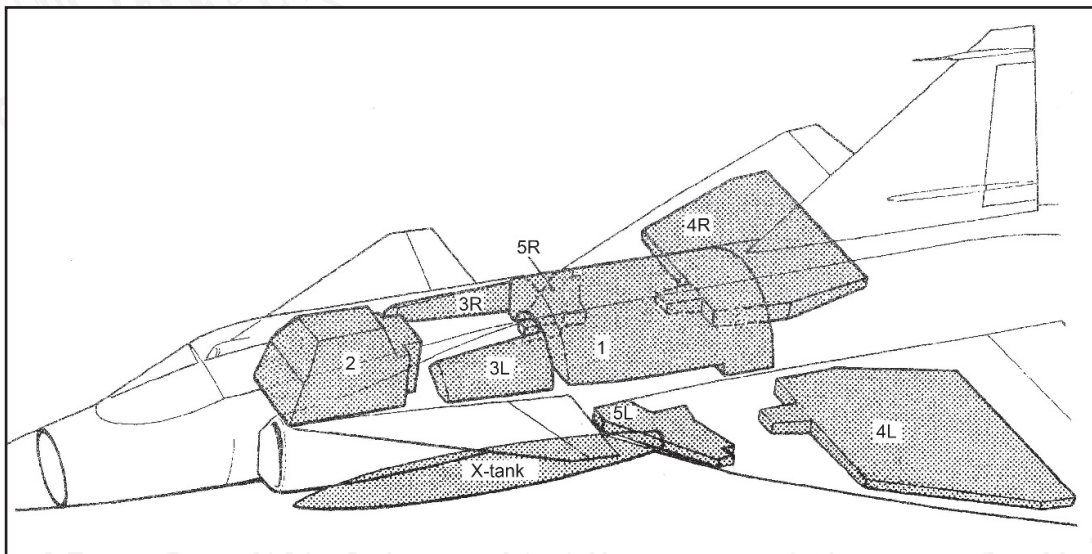

Figure 50. Fuel tanks.

Collection tank

Tank 1 is the largest of the tanks and where fuel is collected from the feeding tanks to be fed into the engine. The tank has two smaller compartments that each contain about 2% (of the total) of fuel to be able to provide the engine fuel during inverted flight and/ or negative G-loads. To refill the tanks, military power (max dry thrust) with a positive G-load is required for about 15 seconds.

CAUTION: Inverted flight is not limited by fuel but rather the engine lubrication system to 10 seconds. Full afterburner is possible during those 10 seconds. The warning OLJETRYCK will appear to indicate low oil pressure after a few seconds of flight with negative G-loads.

Failure to restore a positive G-load and engine lubrication may cause engine damage.

Flow Distributor

The flow distributor is a system of pumps designed to distribute fuel from the feeding tanks to the collection tank symmetrically. A fault in the system is indicated by the warning light BRÄ UPPF being lit.

Fuel pumps

The fuel pumps are AC powered and controlled by the low pressure fuel valve switch LT-Kran (ON / OFF) on the engine panel and tank pump switch TANKPUMP (NORM / OFF) on the right wall console. The afterburner low pressure fuel valve is controlled by the switch LT-KRAN EBK on the right wall console.

Low pressure in the fuel pumps is indicated the warning light TANK PUMP.

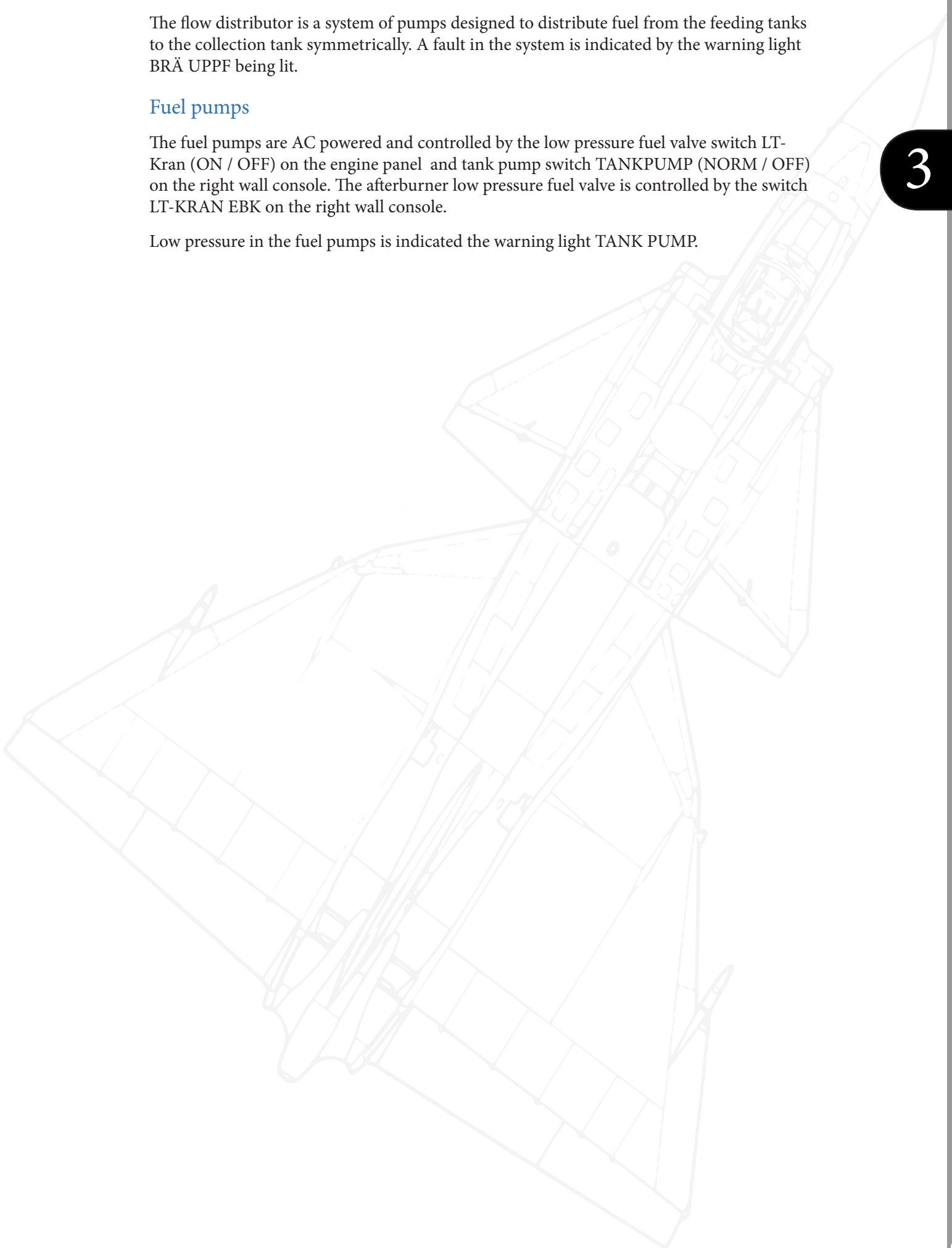

Fuel system function

Start-up

Before start-up, the indicator lights BRÄ UPPF and TANKPUMP are lit, along with the indicator lamp next to the LT-KRAN switch. Indicator light X-TANK BRÄ is lit if the external fuel tank is attached and contains > 3% fuel.

Low pressure fuel valve switches for the engine (LT-KRAN) and afterburner are set to ON / TILL. When both valves are opened, the red indicator light turns off.

During the engine start up, the flow distributor and pumps start working. When the tank pressure increases to normal levels, the warning light BRÄ UPPF turns off.

When the main generator comes online, the tank pumps come online under condition that the switch TANKPUMP is set to NORM. When pressure increases to normal levels the warning light TANKPUMP turns off.

The indicator light X-TANK BRÄ continues to be lit until the tank pump pressure in the external fuel tank has built up, which occurs at about 70% engine RPM.

Normal use

Normally, the external fuel tank is drained first, and thereafter the internal feeding tanks and lastly the collection tank. If fuel consumption is very high (25000l/h) fuel is fed from both the external and internal tanks simultaneously.

When the fuel amount goes below 24% and the landing gear is retracted, the warning light BRÄ <24 is lit along with a master caution alarm. The light remains on for the duration of the flight.

External tank.

The external tank can be dropped at any time regardless of the amount of fuel in it by pressing the button X-TANK emergency release on the weapons panel. This is blocked when the aircraft is on the ground (nose wheel depressed).

Fuel system warnings

Faults are indicated by the warning lights BRÄ UPPF, TANKPUMP or X-TANK BRÄ. During the first two, a Master Caution alert is triggered. Additionally, there is a low fuel warning to caution the pilot.

BRÄ UPPF

Indicates low pressure after the flow distributor

- Check that LT-KRAN (Low pressure fuel valve) and HUVUDSTRÖM (Main power) are turned on.
- Can occur due to a low hydraulic pressure in system 1 as the pumps run on this circuit.

TANKPUMP

Indicates if the fuel pressure after the tank pumps is too low, which is due to either or both of the two tank pumps having stopped.

X-TANK BRÄ

Indicates a fault in the external fuel tank. Should be visible below 70% RPM due to lack of pressure.

BRÄ < 24%

Fuel amount warning. Indicates that fuel remaining is less than 24%. Causes a master caution alarm on activation.

Fuel system cockpit overview

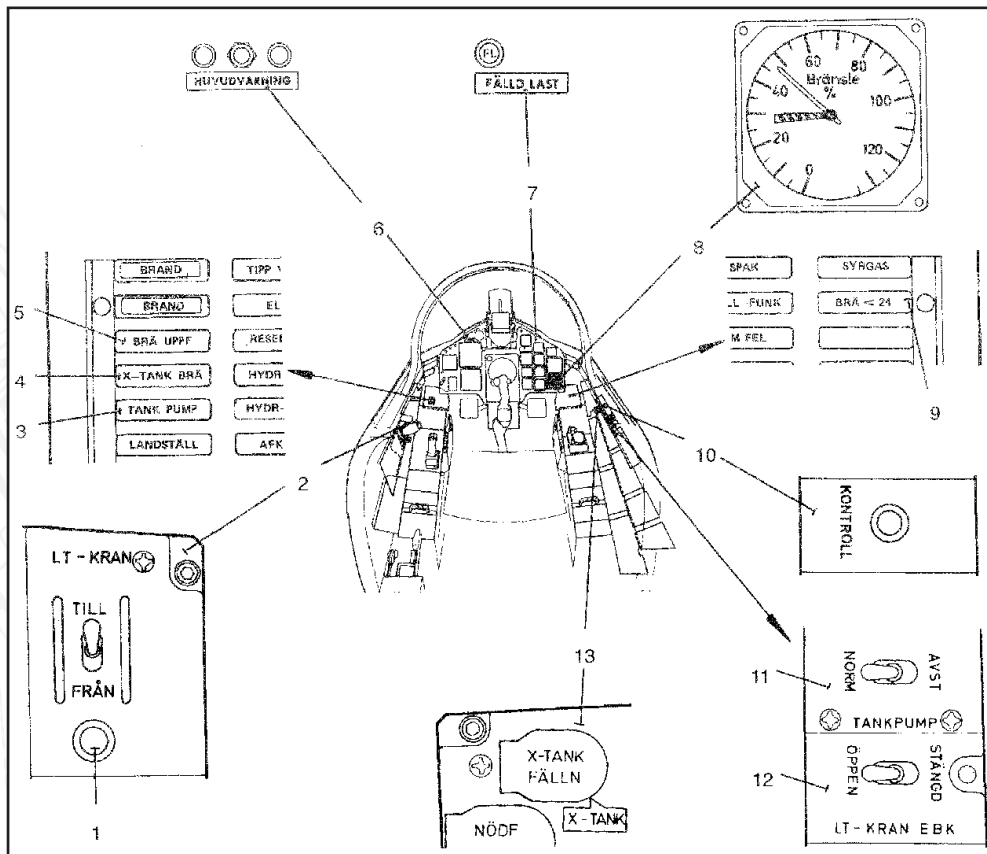

Figure 51. Fuel system controls overview.

- | | |
|---|--|
| 1. Low pressure fuel valve indicator light
LT-KRAN | 8. Fuel indicator |
| 2. Low pressure fuel valve switch LT-KRAN | 9. Indicator light BRÄ < 24 |
| 3. Indicator light TANKPUMP | 10. Indicator system check KONTROLL |
| 4. Indicator light X-TANK BRÄ | 11. TANKPUMP selector switch |
| 5. Indicator light BRÄ UPPF | 12. Afterburner low-pressure fuel valve
LT-KRAN EBK |
| 6. Master Caution lights | 13. External tank jettison X-TANK |
| 7. Stores released indicator light | |

Flight control system overview

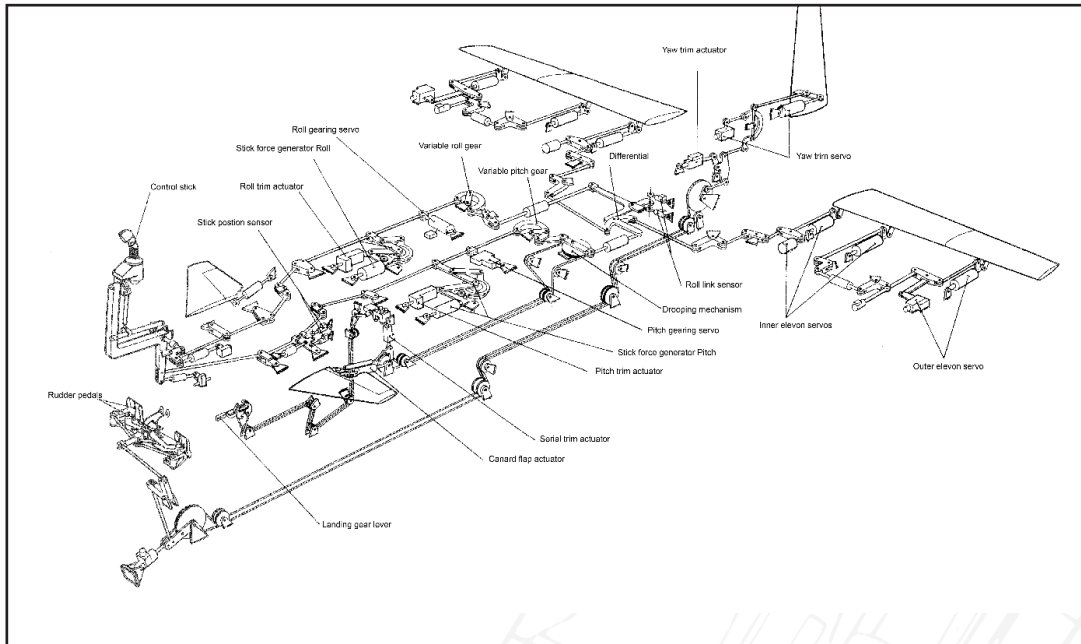

Figure 52. Flight control system overview

The AJS-37 flight control system is divided into two main categories operating in parallel.

First is the mechanical control system, called GSA (GrundStyrAutomat) which serves as a system of mechanical linkages from the control stick to the hydraulic servos. A series of differentials and gearboxes serve to vary control surface deflection with airspeed and altitude.

Second is the input from the autopilot SA06 (Styrautomat 06), which interfaces with the outer elevons and the rudder servo, which in conjunction with the mechanical input will control the aircraft. The control system is essentially two levels of systems working together, one being the mechanical system and the other being the autopilot inputs.

Control surfaces

Due to the delta wing design, the Viggen lacks separate ailerons and elevators as commonly seen in conventional wing designs but uses a combined type of surface called elevons. The inner and outer surfaces on each wing are connected via a one-way linkage, wherein the movement of the inner surface affects the outer surface. However, the outer elevons have a slightly larger range of deflection and can have a separate movement from the inner surfaces (max 10.4°). In addition, the outer elevons have an electrical input from the autopilot SA06. The inner wing surfaces are controlled by the pilot via the mechanical inputs, and indirectly control the outer surfaces either via the linkages or by the inputs interpreted by the autopilot.

Stick design

The pilot controls the pitch and roll of the aircraft with the control stick. The movements are transferred via mechanical linkages to the differential. In addition to this, there is a force sensor on the stick which sends impulses to the autopilot unit proportional to the force exerted on the stick.

Differential

Pitch and roll movement are combined at the differential and sent to the inner wing elevons. A pure pitch movement will deflect the elevons equally, however the introduction of a roll movement will deflect the surfaces in opposite directions, yielding a roll and a pitch at the same time.

Pitch gearing

In order to have a greater range of control of pitch at different airspeeds, the pitch system is fitted with a variable gearing. The gearing is designed to change the relationship between stick input and the control surface deflection with decreasing surface deflection for a given value of stick input in regards to the increased control surface effectiveness with higher airspeeds.

The pitch gearing is based on altitude and airspeed information provided by the backup pitot system mounted on the fin.

In case of failure or error, the pilot is alerted by the light "TIPP VÄXEL" (Pitch gearing) on the left indicator panel.

The pitch gearing can in this case be set manually to the landing mode, by setting the switch TIPP VÄXEL (Pitch gearing) from automatic (AUTO) to landing mode (LANDN). The warning light will remain on.

The system is hydraulically powered by the second hydraulic system (HYD SYST 2). In case of hydraulic failure, the warning TIPP VÄXEL will not appear, unless the TIPP VÄXEL switch is set to landing mode.

Roll gearing

Similar to the pitch gearing, the roll gearing is designed to change the necessary stick input for roll movement at different airspeeds. As opposed to the pitch gearing with a more variable gearing over a larger range, the roll gearing has two distinct modes, low-speed and high speed.

The change between low and high-speed modes is automatic and occurs when the aircraft passes 350 km/h and takes about 5 seconds.

In order to increase safety, the change function is based on two sources, one sensor in the flight data unit (using the main Pitot tube) and one in the fin-mounted backup Pitot tube system.

The logic is as follows.

- If the landing gear lever is in position IN, both sources need to show an airspeed of less than 350 km/h in order to engage the low-speed mode.
- In case the landing gear lever is in position OUT, only one of the sensors need to indicate less than 350 km/h in order to engage low-speed mode.

This means that in the case that the two pitot tube systems are not indicating the same value, the roll gearing will enter high-speed mode if the landing gear is retracted and low-speed if landing gear is extended.

Caution: In case the gearing is still in low speed mode over 350km/h, the aircraft will be very sensitive in roll. The opposite applies for the roll authority in low speeds when the gearing is in high-speed mode.

In case of failure, the warning light ROLL VÄXEL will appear on the right indicator panel.

In case of hydraulic failure the warning ROLL VÄXEL will not appear. In case of a hydraulic system 2 failure, the gearing will leak and slowly move towards the high-speed mode.

Rudder system

The rudder is controlled by the rudder pedals and electrically by the autopilot.

The rudder is trimmed by the potentiometer SID-TRIM. During the Autopilot modes ATT and HÖJD, the trim is automatically controlled by the autopilot.

Trim system

The aircraft lacks trim tabs and instead operates by moving the neutral position of the control stick. The trim is operated by a small hat switch on the control stick.

During the autopilot modes ATT and HÖJD (attitude or altitude hold) the normal trim system is disabled. The trim in these modes is instead controlled by the autopilot, automatic trimming. The hat switch instead is used for operating the autopilot.

Pitch trim is indicated by the trim indicator on the front left side panel. Indicates trim setting in $\pm 10^\circ$ nose up (Nos upp) / nose down (Nos ned).



Figure 53. Pitch trim. 3° nose up trim.

Emergency trim

In case of a failure of the normal trim system, there is an emergency trim system. The switches NÖDTRIM TIPP (emergency pitch trim) and NÖDTRIM ROLL (emergency roll trim) control pitch and roll emergency trim respectively. Once the emergency trim system has been activated, the normal trim hat on the control stick can only be operated if the circuit breaker TRIMSYST (right side CB panel) is cycled.

Airbrakes

The aircraft is fitted with 4 airbrakes, two on the top of the fuselage and two on the bottom. The two bottom airbrakes are constructed from a glass fibre laminate to avoid interference with the radio antenna in the belly fin.

The airbrakes are operated by a switch on the throttle. The airbrakes extend when pulling the switch backwards and retract when the switch is moved forwards.

When the landing gear is deployed, the airbrakes will automatically retract. In order to extend the airbrakes, the switch has to be held in an open position.

The light LUFTBROMS on the right indicator panel indicates that the airbrakes are fully or partially extended.

Due to excessive nose-down movements caused by the airbrakes, they are disabled above an airspeeds above Mach 0.92.



Figure 54. Airbrake system (Upper and lower).

Flaps

The flaps are mounted on the rear of the canards and are automatically lowered and raised hydraulically with the undercarriage lever. The flaps aid in providing a nose-high attitude by providing more lift on the canards. Due to the change in rotation caused by this, the elevon control surfaces are automatically drooped slightly to compensate. The drooping mechanism works in parallel with the ordinary control system and will not cause the neutral position of the control stick to change.

When retracted the flaps are either retracted to a positive (upwards) position of 4 or 7° depending on the aircraft load out. Due to certain tail-heavy ordnance such as AKA gun pods and ARAK rocket pods, the flaps are set to a -7° position to offset this imbalance. This setting cannot be accessed by the pilot but is set by the ground crew when arming and readying the aircraft.



Figure 55. Flaps (raised and lowered positions).

High alpha warning (HAW) system

In order to avoid excessive angles of attack, the pilot is warned when the angle of attack (AoA or α) exceeds or quickly approaches the angle of attack limit. The pilot is warned by a vibrating membrane in the control stick as well as a pulsating audio tone.

HAW Maximum angle of attack

Landing gear lever position	Autopilot mode	
	GSA and SPAK	ATT and HÖJD
IN	18°	15°
OUT	15°	15°
OUT and AFK (Autothrottle) mode 3 (α 15.5)	18°	15°

The HAW system can be toggled by the HAW circuit breaker (HAW) on the circuit breaker panel.

Landing gear, brakes and nose wheel steering

3

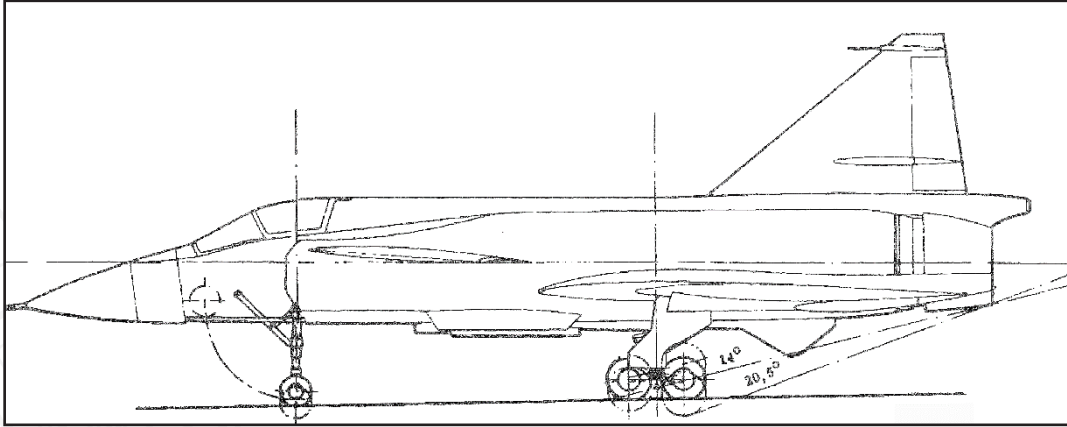

Figure 56. Landing gear and rotation limits.

The undercarriage on the Viggen is of a tricycle configuration. The main landing gear is designed to sustain a large amount of force during hard landings. For that purpose, two wheels are mounted in tandem on a bogie. The bogie will rotate slightly when the aircraft rotates and will absorb some of the impact during landing, along with the powerful shock absorbers.

The nose gear consists of two parallel wheels on a slightly forward canted strut.

The landing gear will depending on the weight on the rear wheels allow a 14- 20.5° nose-up attitude without a tail strike. A normal landing will have a 16° nose-up attitude during the aerodynamic braking and touch-down.

Landing gear lever

The landing gear is operated by the landing gear lever. The lever has two positions.

Position IN: Upper position. Landing gear retracted. Canard flaps retracted and angled -4° or -7° depending on loadout setting. Autothrottle (AFK) if engaged Mode 1 V_i 550 km/h.

Position OUT: Lower position. Landing gear extended. Canard flaps extended $+30^\circ$. AFK mod 2 (α_{12°)

The landing gear lever is electrically locked in position IN (preventing landing gear extension) above airspeeds of 620 – 700 km/h or Mach numbers above 0.65.

Similarly, the landing gear lever is locked in position OUT (preventing landing gear retraction) if the throttle position is lower than corresponding to 85% engine RPM.

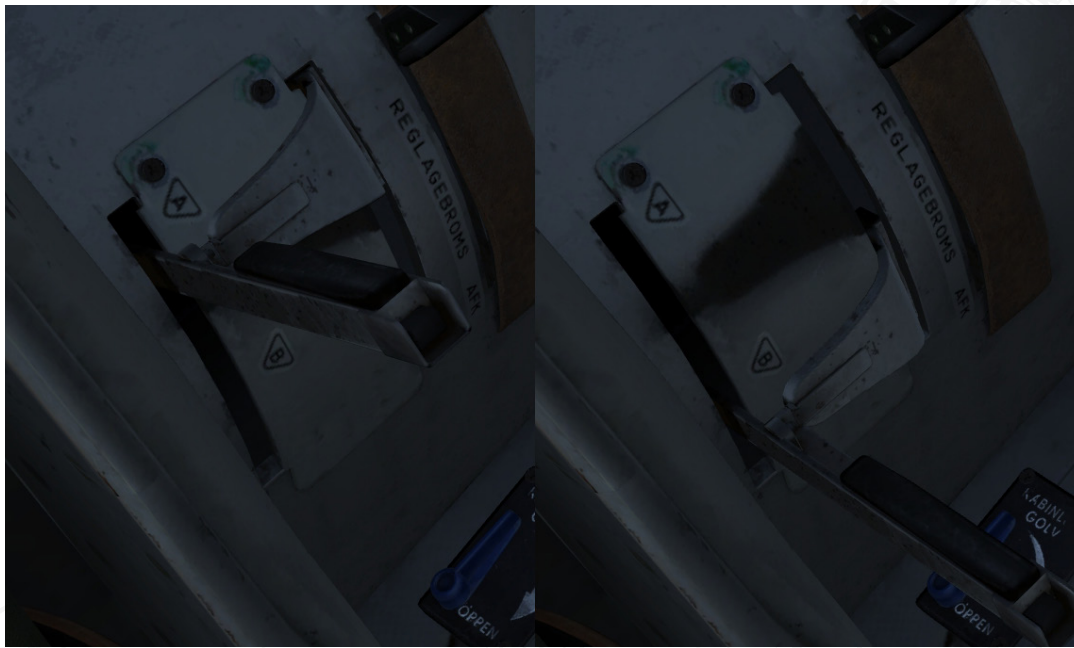

Figure 57. Landing gear lever. Left: Retracted (IN) position (A). Right: Extended (OUT) position (B).

Emergency extension

In case of failure of hydraulic system 1, the landing gear can be deployed via reserve pressure cylinders in hydraulic system 2. The landing gear bay doors are actuated by the pressure and lock their open position. The landing gear lowers by its own weight and aerodynamic forces and will lock in position when fully extended. The extension is operated as ordinary by setting the landing gear lever to OUT.

Indicators

Each landing gear indicator is lit (green) when indicating that the individual gear is extended and locked.

NOSSTÄLL: Nose gear

V STÄLL: Left main gear

H STÄLL: Right main gear

3

Figure 58. Landing gear indicator on left warning / indicator panel.

The indicator LANDSTÄLL indicates:

- Landing gear extension is underway. LANDSTÄLL solid.*
- Landing gear lever not locked in either IN or OUT positions.*
- Landing gear retracted at airspeed < 375 km/h, altitude < 1500m and throttle position < 90% RPM.**
- Landing gear retracted with a failure of the air data unit and throttle position < 90% RPM

*After 10 seconds the LANDING GEAR / LANDSTÄLL indication will start flashing and cause a Master Caution.

**LANDING GEAR / LANDSTÄLL flashing and MASTER CAUTION.

Wheel brakes

The aircraft is fitted with antiskid brakes. Within the braking mechanism, if the wheel stops turning, a small vent opens and decreases brake pressure until the wheel starts turning again. This aids in preventing skids during hard braking or slippery surfaces.

The brakes are applied by depressing the brake pedals and can be individually applied when a smaller turning radius is needed.

Caution: Asymmetric braking should not be used during thrust reversal due to the possibility of yaw instability.

3

A brake pressure indicator is situated on the left front side panel.



Figure 59. Brake pressure indicator.

The wheel brakes can be locked by depressing the brakes and pulling the parking brake handle. Brakes are released by depressing brake pedals again.

Nose wheel steering

The nose wheel can be steered by depressing the rudder pedals left or right. It is operated by hydraulic pressure and will not operate in case of a failure in hydraulic system 1.

The nose wheel has a maximum range of $\pm 30^\circ$.

Flight control system cockpit overview

3

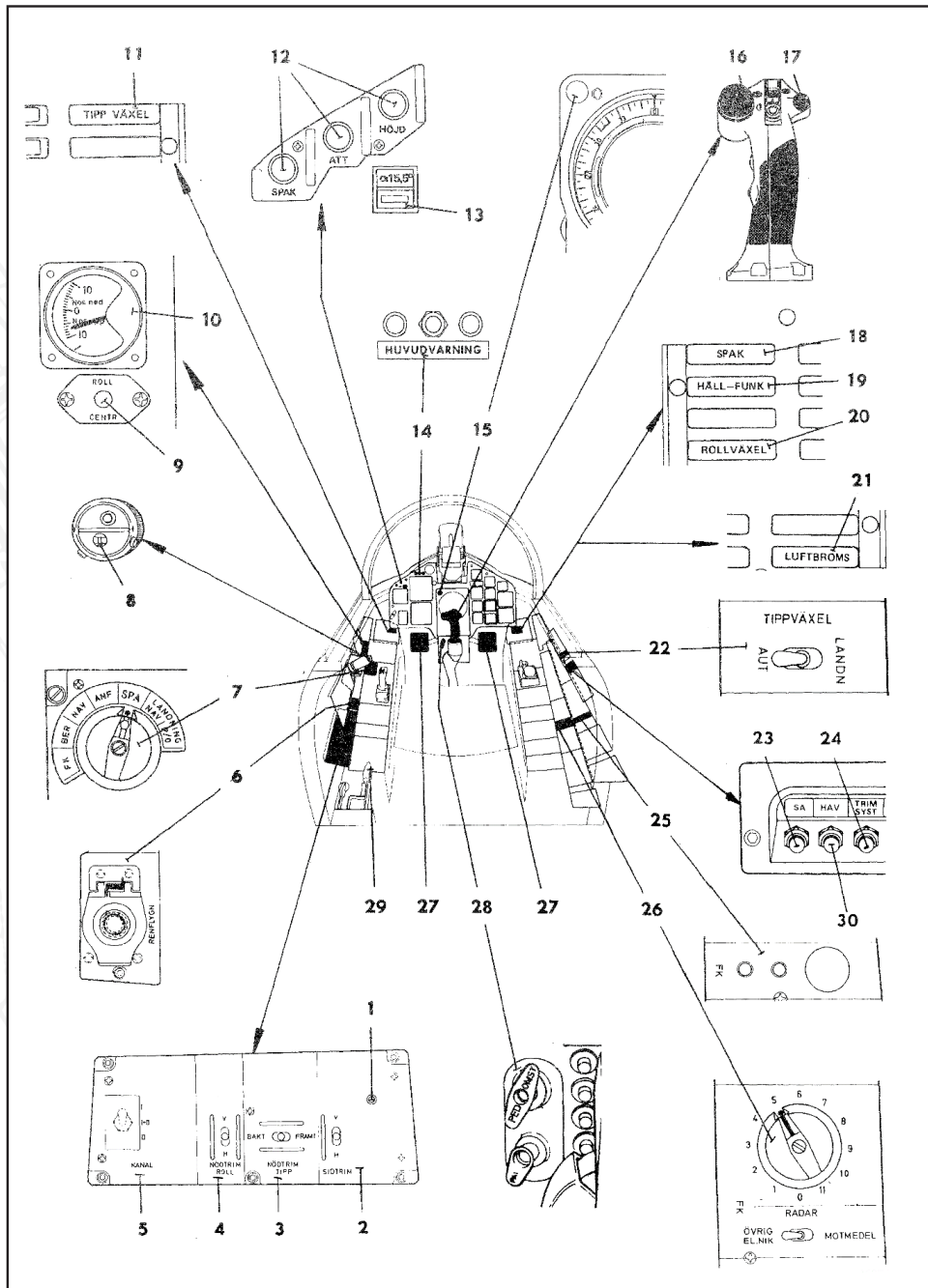

Figure 60. Flight control system cockpit controls

- | | |
|---|---------------------------------------|
| 1. Yaw trim indicator (indicated centered yaw trim) | 6. Autopilot yaw trim. |
| 2. Yaw trim. | 7. Master mode selector |
| 3. Emergency pitch trim | 8. Air-brake extend / retract |
| 4. Emergency roll trim | 9. Roll trim center |
| 5. Autopilot channel switch [No function] | 10. Pitch trim indicator |
| | 11. Pitch gearing warning (TIPPVÄXEL) |

12. Autopilot mode indicator and selection buttons.
13. AFK mode 3 (15.5°) indicator and selector
14. Master Caution
15. Altitude warning light
16. Trim hat
17. Autopilot fast-disconnect
18. SPAK warning light
19. Autopilot warning light (HÅLLFUNK)
20. Roll gearing warning.
21. Airbrake indicator (LUFTBROMS)
22. Pitch Gearing mode selector
23. Circuit breaker, Autopilot. (SA)
24. Circuit breaker, trim system (TRIM SYST)
25. Function check indicator [No function]
26. Function check mode selector [No function]
27. Rudder pedals
28. Rudder pedal adjust lever
29. Landing Gear Handle
30. Circuit breaker, High-alfa warning (HAV)

Autopilot SA-06 (SPAK, ATT, HÖJD, Standard Turn, HAW)

The aircraft is fitted with an autopilot, the SA06 (Styrautomat 06). The autopilot operates by sending electrical impulses to the outer wing elevons servos and the rudder servo. The function of the autopilot is twofold. The first is to dampen the aircraft movement in all three axes. The second is to stabilize the aircraft in course, attitude and altitude (hold functions).

The 3 main modes for the autopilot are:

- SPAK
- ATT (attitude hold)
- HÖJD (Altitude hold)

The selected modes are indicated by the three lights on the top left on the instrument panel. The lights also serve as selection buttons. The selected mode is lit when active.

SPAK

SPAK is the main dampening mode of the autopilot. It is engaged automatically and will continually dampen movement in all three axes (pitch, roll, and yaw) in order to stabilize the aircraft. SPAK is the normal operating mode of the autopilot and should be engaged at all times during normal flight.

The force sensor in the control stick sends a proportionate signal to the exerted force exerted to the autopilot, where it is then summarised with the dampening channel from which then pitch and roll impulses are sent to the outer wing elevons.

Due to the aerodynamic changes and forces exerted during transonic flight ($> \text{Mach } 0.93$) in mode SPAK, the aircraft will automatically trim the aircraft in pitch via the series trim system to avoid the drastic changes in pitch moment. In mode GSA, there will be a certain amount of "mach tuck" where the nose will be slightly forced down, requiring pilot input to correct.

ATT

ATT is the attitude hold function. When engaged the autopilot will attempt to maintain current attitude. The pitch angle can be fine-tuned with the pitch trim on the hat switch. Pushing the trim up / down will cause a new reference attitude to be made in pitch.

The mode will maintain the pitch angle when it is engaged and will maintain roll angle if the angle is $> 7^\circ$ and $< 66^\circ$.

If the roll angle is $< 7^\circ$, the autopilot will enable a course hold where the autopilot will level the wings and maintain the present course. The pitch angle is unaffected. If the aircraft has drifted from the set course the autopilot will send a signal to the rudder servo and steer the aircraft back onto the set course.

Standard Turn

If the course hold is engaged, the pilot can use the Standard Turn mode in which the aircraft will maintain a constant bank angle. The bank angle is dependent on the airspeed of the aircraft in order to yield a constant turn radius of 4.1km if the airspeed is less than Mach 0.8. Above Mach 0.8 the turn radius instead becomes a constant g-load of 1.41 G instead.

The change in bank angle causes a slight nose down moment which is countered by a change in pitch movement to maintain altitude.

Standard turn is engaged by pushing the trim hat switch left or right depending on the desired turning direction. The direction of the turn can be reversed by pressing in the other direction of the present turn twice.

HÖJD

HÖJD is the altitude hold system which is the highest operating autopilot mode, and commands the autopilot to maintain the current barometric altitude as well as attitude hold in roll or course hold depending on the bank angle (same as the parameters of ATT).

During transonic flight (Mach0.97-M1.05) the autopilot enters a special attitude mode (HÖJD / TRANSSONIK). This is due to lack of reliable data from the Pitot tube system at such airspeeds. The normal altitude hold mode reengages when leaving these airspeeds.

The set altitude can be fine-tuned by the pitch trim hat switch.

Indication

SPAK: SPAK is lit.

ATT: SPAK and ATT lit

HÖJD: SPAK, ATT, and HÖJD lit.

Note. During HÖJD/TRANSSONIK: SPAK and TRANSSONIK (Tr) lit. ATT and HÖJD flashing alternately.



Figure 61. Autopilot mode selector buttons. SPAK mode on.

Flight data unit system and FLI37 ADI

The aircraft features two pitot systems, a main pitot system feeding into the Flight data unit LD04 and a backup pitot system in case of main pitot system failure for the backup instruments.

Main pitot system / Flight data unit

The main pitot is mounted on the nose cone. The total and static pressures are fed to the flight data unit for calculation of airspeed, altitude and Mach-speed. Further sensor units are the temperature gauges for measuring ambient air temperature and angle of attack sensors.

Pitot heating is entirely automatic and requires no pilot input.

Accelerometer unit

An accelerometer unit for calculating aircraft movement in X- and Z-axes. The measured movements are sent to the CK37 computer and the Autothrottle (AFK) unit.

Backup pitot system

The backup pitot system is mounted on the tailfin and is used for the backup instruments in the event of a main pitot or flight data unit failure.

The backup pitot system is heated automatically.

FLI37 Attitude Director Indicator (ADI)

The FLI 37 Attitude director indicator (ADI) is the main indicator of the aircraft orientation. It indicates pitch, roll, and course angles, as well as side slip and vertical velocity.

The command steering needles display steering commands from the CK37 in pitch and course angles. The needles are stowed during take-off mode, visual landing mode (LANDN P/O), or when the HUD slave (SLAV-SI) switch is in position ON (TILL), as well as during CK and primary data errors.

The needles are not stowed if TILS is locked on the glideslope and localiser. In the event there is a primary data or CK error, the needles will display will raw data from the TILS instead.

The FLI37 ADI fast erects (aligns) on start-up. The initial course setting (manual or during take-off) will further refine the displayed course. The fast erect can be repeated in case of an error or failure. This is done by pressing a button at the bottom of the central indicator. Fast erect should be done in acceleration free flight to avoid errors during alignment.

The Course correction knob (KURSKORR) is used for setting the local magnetic declination.

Please refer to the "Navigation system" and initial course setting section of the procedures section for further details.

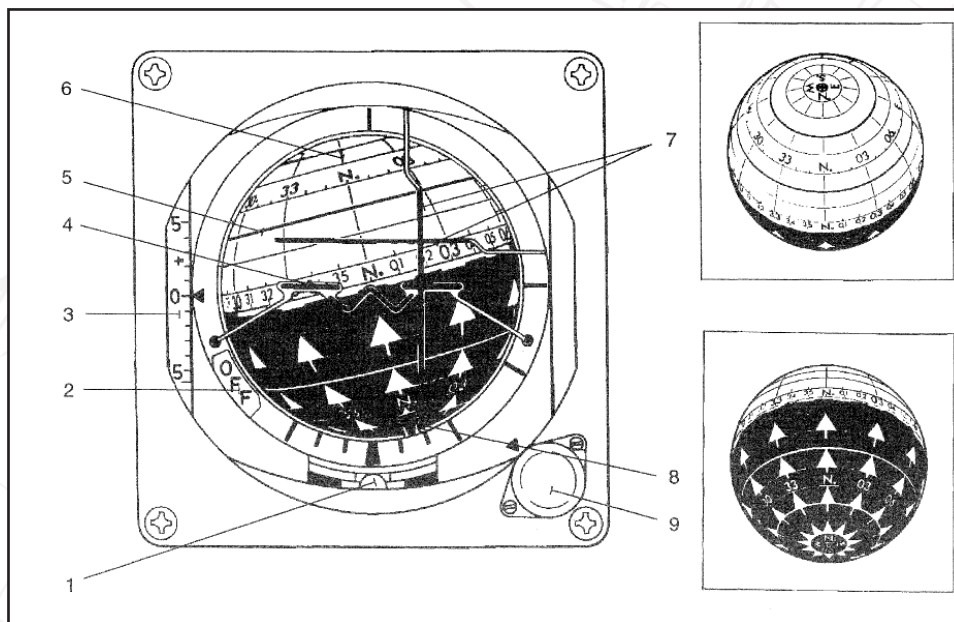

Figure 62. Attitude Director Indicator.

- | | |
|--|-----------------------------|
| 1. Slip ball | 5. Pitch angle indication |
| 2. Warning flag | 6. Course angle indication |
| 3. Vertical speed indicator / variometer.
Graded in ± 5 metres / second | 7. Flight director needles. |
| 4. Fixed aircraft reference | 8. Roll angle index. |
| | 9. Pitch trim [No function] |

Course indicator ring

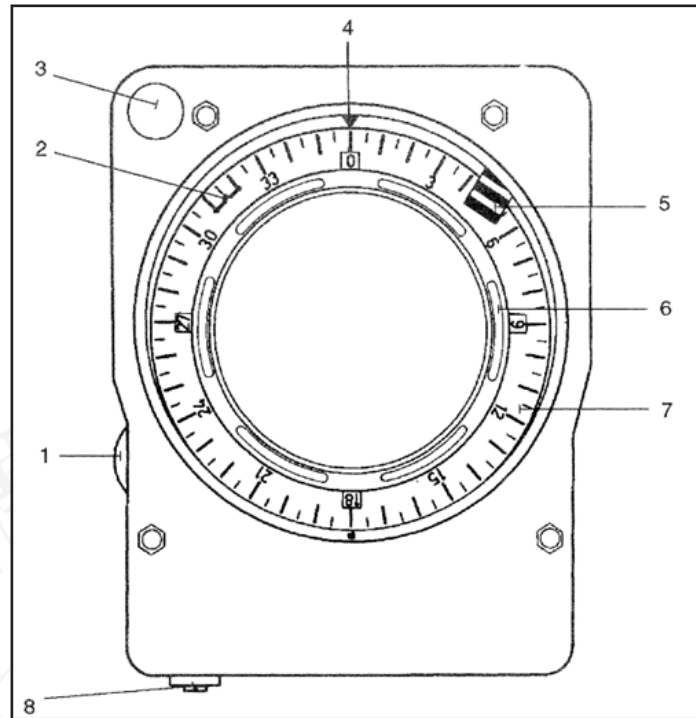

Figure 63. Central indicator.

- | | |
|-----------------------------------|--|
| 1. Radar filter knob | 6. Radar Warning receiver indicator lights |
| 2. Index for commanded course | 7. Moving course scale |
| 3. Altitude warning light | 8. Fast erect button |
| 4. Fixed index for current course | |
| 5. Warning flag | |

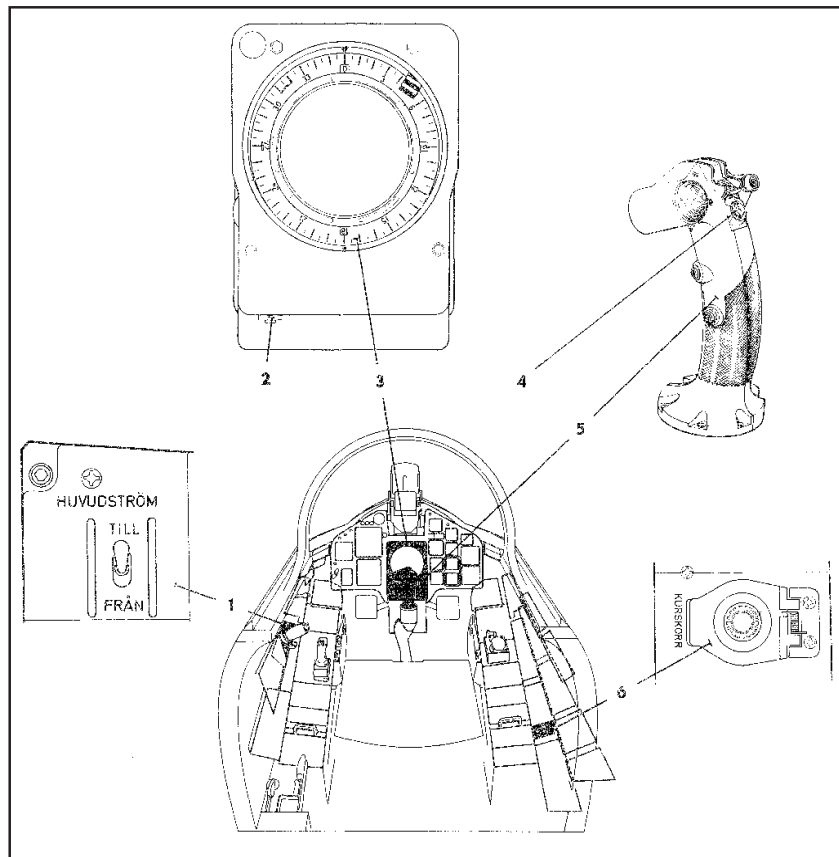

Figure 64. Flight data system controls.

- | | |
|------------------------------------|--------------------------------------|
| 1. Main power switch (HUVUD-STRÖM) | 5. Control stick |
| 2. Fast erect button | 6. Course correction knob (KURSKORR) |
| 3. Course ring | |
| 4. Reference button | |

CK37 computer overview

Overview

The CK37 (Central Kalkylator 37) aircraft computer is one of the first computers mounted to an aircraft. The purpose of the computer is to enable far more advanced avionics and perhaps more importantly, integrated avionics system. The CK37 can be seen as the central nervous system linking the large number of individual systems together. The computer is programmed to handle primary flight data, presentation for avionics, navigation, as well as sight and weapon calculations.

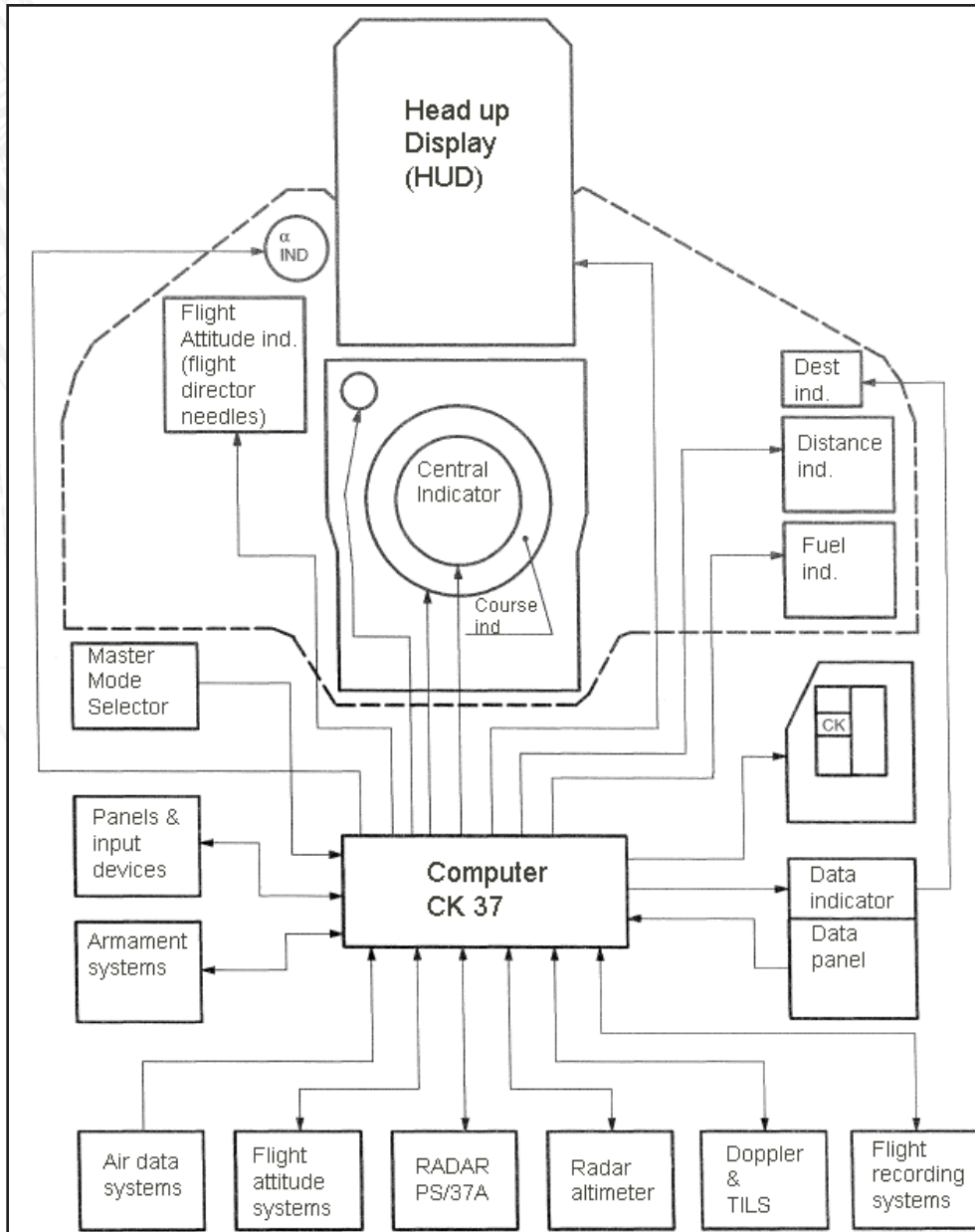

Figure 65. CK-37 Computer and systems layout.

Data panel

The pilot interfaces indirectly with the CK37 on most systems, however the main input / output functions are handled by the data panel mounted on the right side panel.

The data indicator is a 6 digit indicator that will display a series of numbers or symbols depending on the program.

The Data Panel has on the left a mode selector dial which toggles the following modes;

A more detailed explanation of each mode will be given in the procedures section for each respective system. Only a brief overview will be provided here.

- **AKT POS:** Present position. Will display current position as status of navigation system. Out (readout) mode only.
- **REF LOLA:** Reference number or longitude / latitude coordinate positions of waypoints, start base and landing base. Coordinates can either be entered as reference numbers for pre-loaded positions or as longitude / latitude coordinates (six digits each in degrees, minutes and seconds).

IMPORTANT: The longitude and latitude input is reversed due to the systems design of the computer.

Commonly, coordinates are given in latitude / longitude format (eg. N xx° yy' zz", E xx° yy' zz"), while the computer's input / output of the CK37 is longitude/ latitude (E xx° yy' zz", N xx° yy' zz")

- **BANA / GRÄNS:** Inputting runway headings, TILS channels for start and landing bases. Can also be used to insert boundaries for waypoints.
- **VIND/ RUTA / MÅL:** Wind direction and strength for entered wind. Choice between Doppler-derived wind or entered. Position for corners of reconnaissance square and reconnaissance targets.
- **TID:** Present time, Time on Target, ingress Mach speeds, and time for reconnaissance targets.
- **TAKT:** Tactical inputs and presets. Fuel reserve, defining target waypoints and setting pop-up points. Stand-off data. Enable / disable TERNAV system.
- **ID-NR:** Identification number. Readout of data for reconnaissance targets. Readout of memory addresses.

IN / UT (OUT) switch: Toggles between input and output modes in each mode.

RENSA (CLEAR): Can be used on the ground to partially or completely clear all stored data. Can be used during flight to reset fix-correction and target fixes.

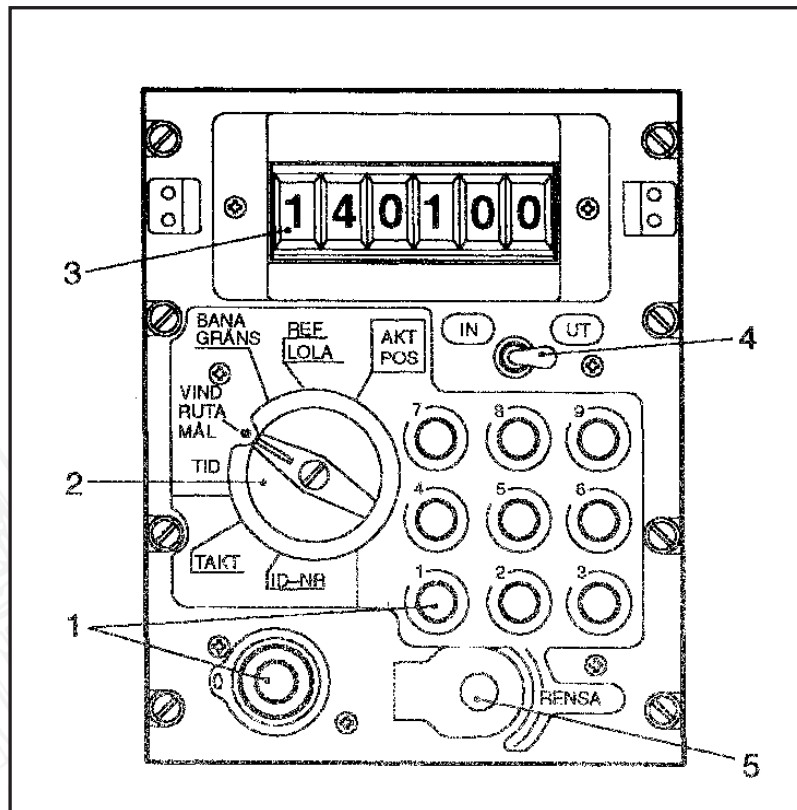

Figure 66. Data panel

1. Number buttons
2. Data selector
3. Data indicator
4. IN / OUT selector
5. RENSA (CLEAR)

In addition to the data panel, some navigation information regarding the selected way-point is displayed on the destination indicator. This will be covered in the Navigation overview section.

Master mode selector

The master mode selector determines the primary operating mode of the aircraft. It can select the following modes:

FK- Function check [no function in DCS].

BER- (Beredskap, Readiness). Standby mode. Used during start-up and data input prior to taxi.

NAV: Navigation mode. Used during most navigation flying.

ANF: (Anflygning, Attack) Used for weapons employment (with certain exceptions).

SPA: (Spaning, Reconnaissance) Used for reconnaissance functions.

LANDNING NAV: Navigation Landing, used for instrument approaches and TILS approaches.

LANDNING P/O: (PAR, Precision Approach Radar / Optical) Used for visual approaches and landings.

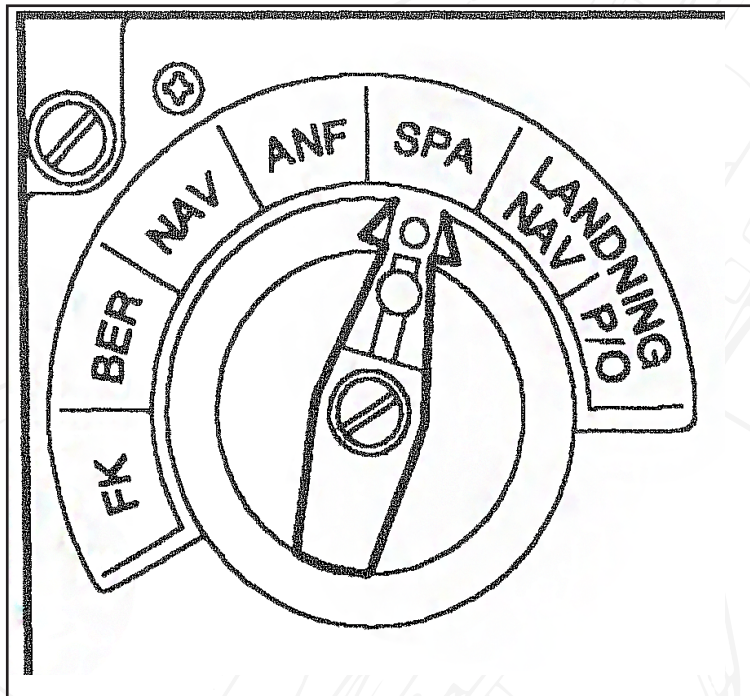

Figure 67. Master mode selector. Mode SPA (reconnaissance) selected.

Avionics overview

The main source of presentation of the avionics is the Head Up Display (HUD) and the Central indicator (CI). Together, they are referred to as the EP-08 system.

Head Up Display

The Head up display is designed to provide the pilot with visual references to aircraft attitude, flight information, and generally improving pilot ergonomics. Additionally the HUD provides the sighting mechanics for the majority of the weapons.

The HUD is based on a cathode tube being reflected via a series of lenses onto the glass panel. The glass frame has a higher and a lower position that allow the presentation of the symbology to be visible during flight at high angles of attack such as during take-off and landing. The HUD position (raised / lowered) is operated by a lever on the left side of the HUD base.



Figure 68. HUD in normal navigation mode.

Central indicator

The Central indicator is mounted in the middle of the front panel and serves as both the display for the PS-37/A radar and the presentation of the App-27 radar-warning receiver (RWR) system. The radar display is a cathode storage tube assembly. In addition to displaying the radar picture, certain flight information such as attitude and altitude are overlaid on the display to maintain orientation when using the radar display.

The radar display has two main operating modes, Sector PPI and B-scope:

Sector Plan Polar Indicator (PPI) will provide a polar coordinate system that is correct in angle and distance. The distance lines and $\pm 30^\circ$ lines aid in interpreting the radar picture.

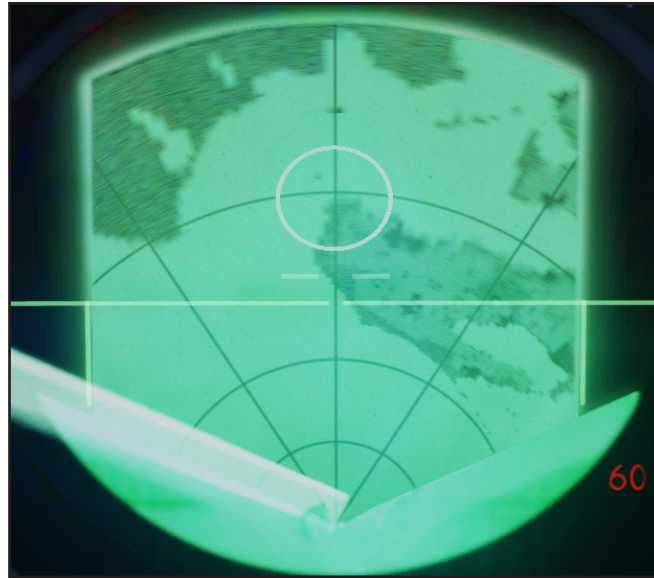

Figure 69. Radar in mode PPI (A1)

B-scope is a “zoomed in” view of a particular part of the sector PPI. The presentation is that of a perpendicular coordinate system presented in a square. As such, the sector from the PPI will be slightly stretched at the bottom (closest to the aircraft). The B-scope is used when additional detail of a target or area is needed.

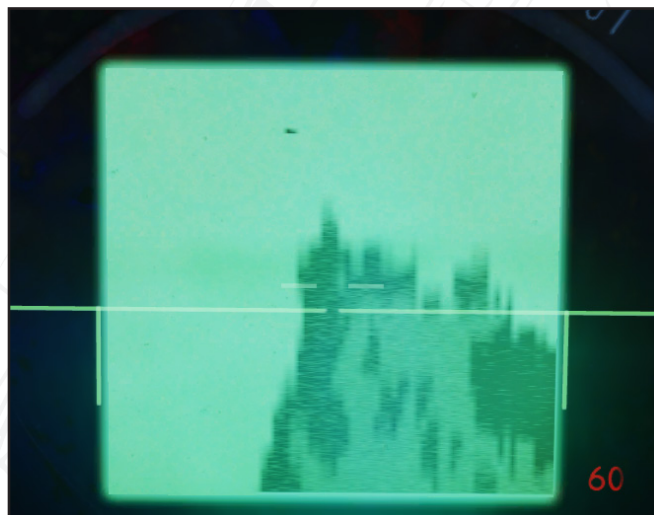
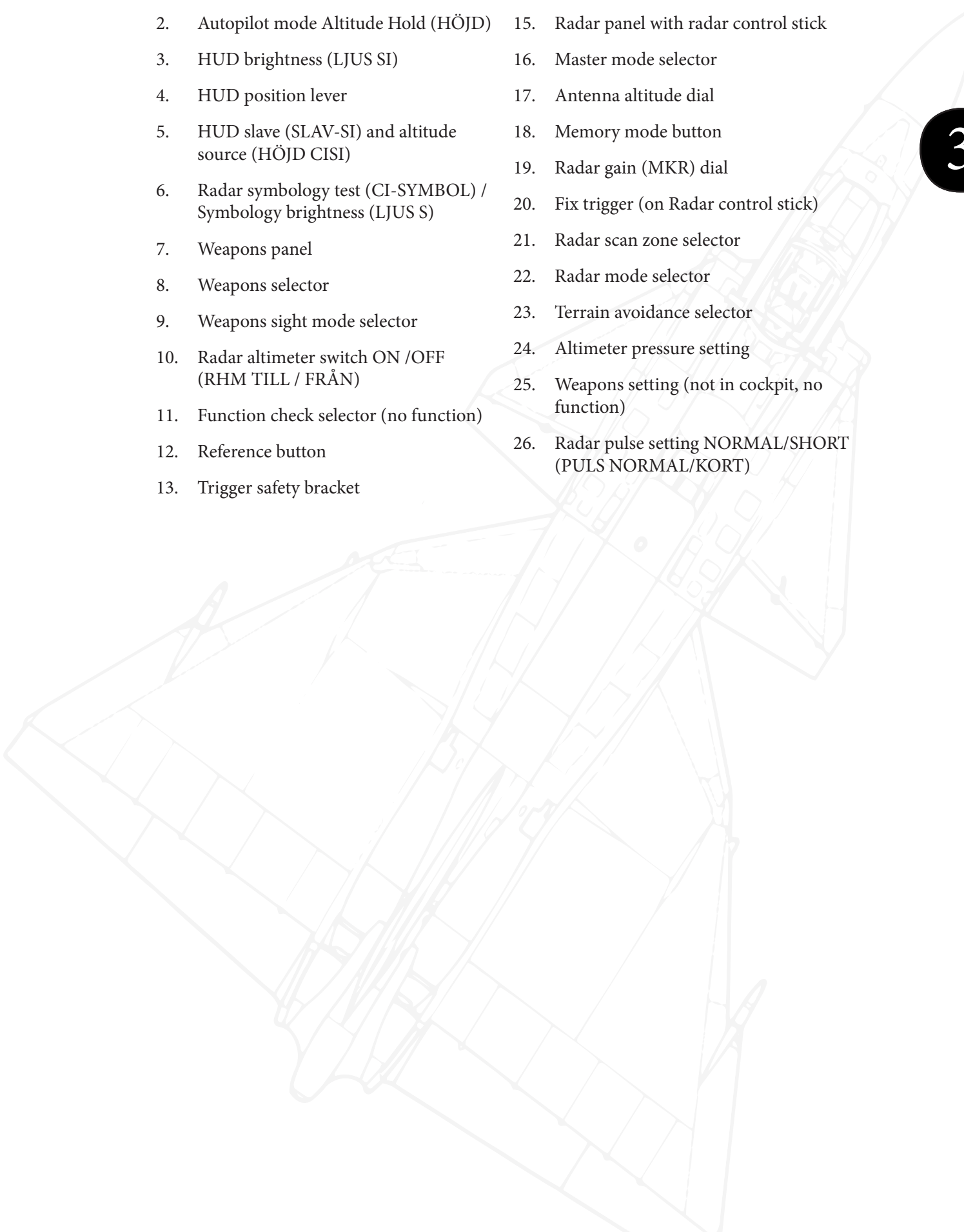

Figure 70. Radar in mode B-scope (A2)

Usage of these modes will be detailed in the respective sections for procedures such as navigation, RADAR use and weapons employment.

- 
1. Radar filter knob
 2. Autopilot mode Altitude Hold (HÖJD)
 3. HUD brightness (LJUS SI)
 4. HUD position lever
 5. HUD slave (SLAV-SI) and altitude source (HÖJD CISI)
 6. Radar symbology test (CI-SYMBOL) / Symbology brightness (LJUS S)
 7. Weapons panel
 8. Weapons selector
 9. Weapons sight mode selector
 10. Radar altimeter switch ON /OFF (RHM TILL / FRÅN)
 11. Function check selector (no function)
 12. Reference button
 13. Trigger safety bracket
 14. Radar brightness dial. (LJUS RADAR)
 15. Radar panel with radar control stick
 16. Master mode selector
 17. Antenna altitude dial
 18. Memory mode button
 19. Radar gain (MKR) dial
 20. Fix trigger (on Radar control stick)
 21. Radar scan zone selector
 22. Radar mode selector
 23. Terrain avoidance selector
 24. Altimeter pressure setting
 25. Weapons setting (not in cockpit, no function)
 26. Radar pulse setting NORMAL/SHORT (PULS NORMAL/KORT)

HUD and CI elements

HUD Symbolology

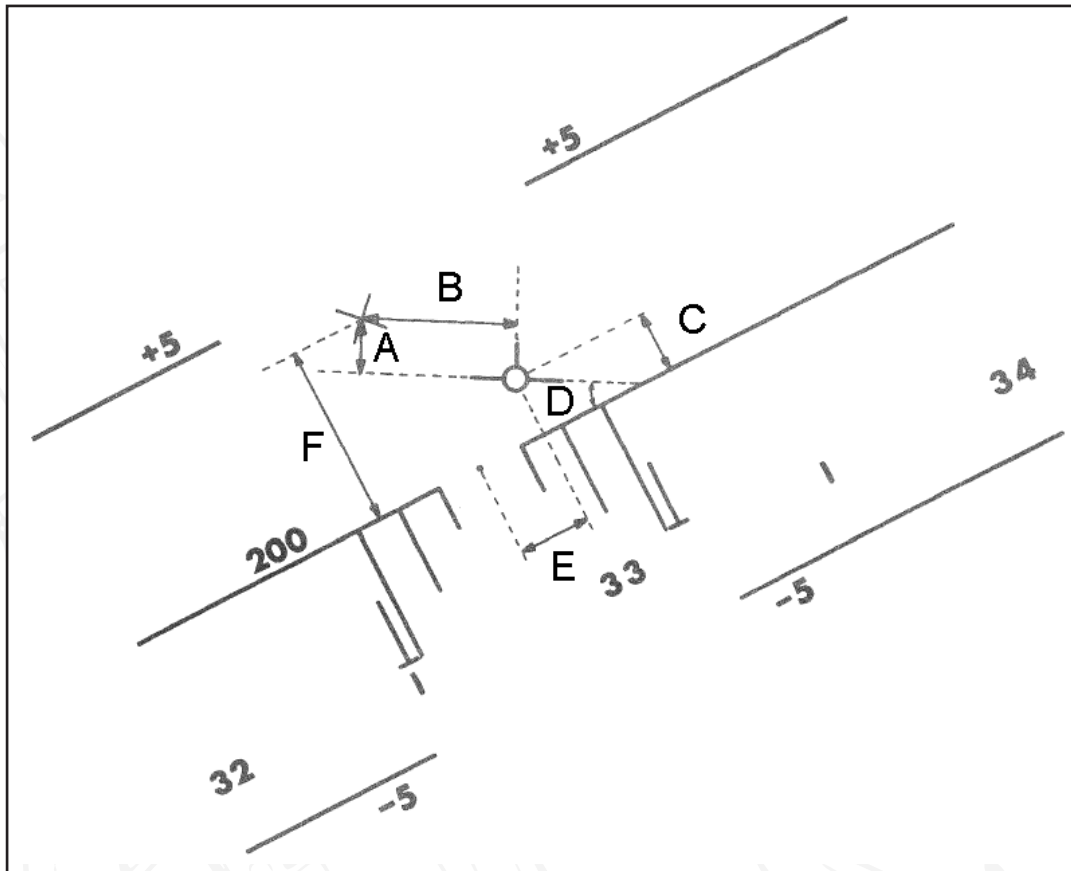

Figure 72. HUD symbology

The cross in the picture indicates the X-axis (front/ back axis) of the aircraft. It is not shown in the HUD, but used as a reference in this picture.

- A. Angle of Attack
- B. Side slip angle
- C. Flight path angle
- D. Roll angle
- E. Course deviation
- F. Pitch angle

Navigation mode

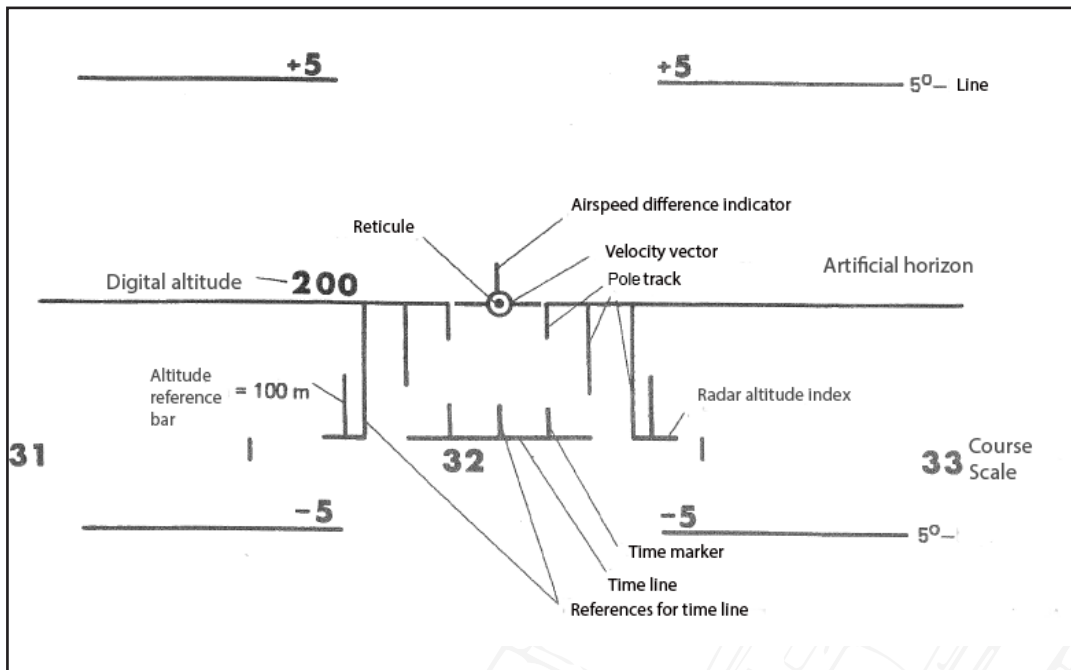

Figure 73. HUD symbology in Navigation mode.

Attitude reference

The artificial horizon provides a frame of reference for the pilot. The +5 and -5 degree lines indicate a reference for flight paths. There are only + / - 5° lines and no complete pitch ladder as seen in more modern aircraft. The entire reference frame may offset from the center (straight forward of the aircraft) left or right, depending if the commanded course from the navigation system is left or right. This is to inform the pilot of the course deviation. When the frame is centred, the aircraft is on course.

Flight path vector (FPV)

Indicates the direction of current flight path vector in a three dimensional space in the form of a stylised aircraft symbol. Wings stick out of the circle at the 9 and 3 o'clock positions. The "vertical fin" at 12 o'clock is the airspeed deviation indicator. Level flight is attained with wings of the FPV lined up with the horizon. If the FPV is centred in the gap in the artificial horizon the aircraft is on the commanded course from the navigation system.

Airspeed deviation indicator (part of flight path vector)

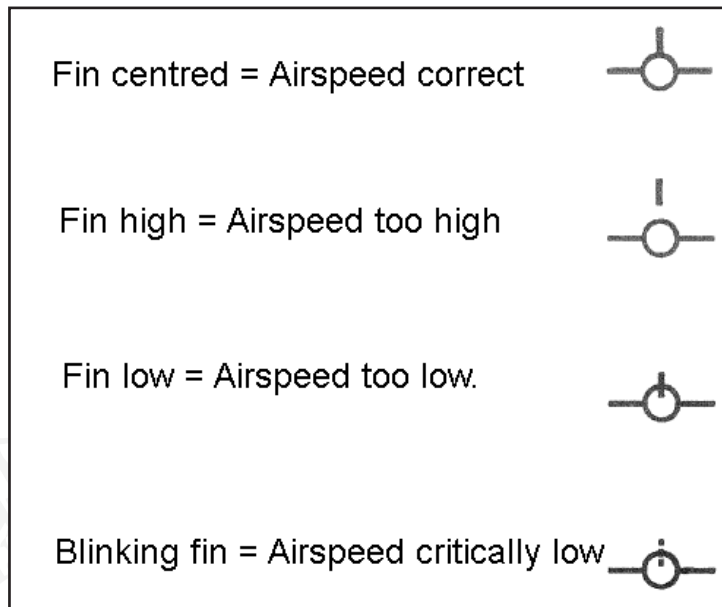

Figure 74. Airspeed deviation indicator.

The airspeed deviation indicator will indicate the relative airspeed required for arriving at the target at the entered time, or a reference airspeed in certain modes.

The fin will move up and down depending on the current airspeed compared to the set reference speed (ingress speeds, landing speed etc.).

For time keeping purposes, the fin indicates a time deviation rather than an airspeed as such. The maximum deviation is one fin-length, which corresponds to a deviation of about 20-30% of the remaining flight time to the target.

Pole track with reference bar.

The pole track is to indicate whether the aircraft is above or below the set reference altitude. When at the correct altitude the top of the poles are aligned with the artificial horizon. The pole track consists of three pairs of lines, with 1°, 2°, and 3° in length.

The length of the altitude reference bar always corresponds to 100 m altitude and can be used as a frame of reference for the set commanded or reference altitude. The relative length of the reference bar compared to the 3° bar is used to roughly indicate the set reference altitude.

For example: At 100 metres, the reference pole will be the same length as the 3° pole. At 200 metres it is half the length of the 3° pole. At 50 metres, the reference bar will be twice the length of the 3° pole.

The reference bar disappears when the set above 500 metres (as the relative length will be difficult to discern above that altitude).

The commanded altitude is dependent on the current mode. The pole track is used for indicating steering commands during approach and landings, as well as indicating necessary altitudes for certain weapons.

In the navigation mode, the commanded altitude can be set by pressing the reference button on the control stick.



Figure 75. Pole-track with reference bar. Commanded altitude at 140 meters

Radar altitude index

The radar altitude index indicates the difference from the CK37 calculated altitude and the unfiltered radar altitude. Only shown when the radar altimeter is in use.

Digital altitude

Shows the current altitude. Source can either be barometric altitude or radar altitude depending on the HÖJD CISI switch. Will normally be displayed on the left side, but may be offset to the right in some situations, such as during weapons release, or in the navigation mode if the centre of the artificial horizon and reticule dot is offset to the right (in order to keep the digital altitude in the field of view).

Between altitudes of 0 and 995 m, the altitude is always presented in 3 digits, with the last digit being a zero (000- 990). Below 100 metres altitude, the altitude is displayed in increments of 5 metres. At altitudes between 995 and 9950 metres, is displayed in kilometres in two digits (1, 0 – 9, 9). Above 10000 m, value should be multiplied by 10 (1,2 can be either 1200 or 12,000 m).

Course scale

Indicates the current heading. Every 10 degrees indicated by the heading number, with 5 degree marks in between.

Time/ distance line

The distance / time line is used to illustrate the time or distance to an event or waypoint. Markers may appear on the line depending on the mode, to indicate a time or distance for recommended action. The line will grow and shrink depending on the mode.

The time line has the following functions:

- During take-off to indicate airspeed. The markers are displaced 2° from the centre index. The timeline will grow as airspeeds increase. Markers indicate recommended rotation speed.
- Timeline **without** markers in master mode NAV or SPA. Indicates time towards destination (current waypoint). The line appears when 6 seconds remains, the line is then stretched 3° from the centre index.
- Timeline **with** markers in mode NAV or SPA. Indicates time left until an action. Markers displaced 1° from centre index. The line is fully stretched when 40 seconds remain until action. When the lines' edges merge with the markers, action should be taken.
- During CCIP mode with bombs. Indicates the bombs time of fall and the markers indicate the bombs arming time.
- During mode LANDN NAV (instrument landing). Indicates time for descent, both for landing waypoint LB and landing point LF.

Distance line has the following functions:

- When attacking with rockets, gun pods or bombs against ground targets. Line indicates range to target. Markers indicate the minimum allowed distance for firing.
- When attacking using RB 04, the line indicates the release envelope. Markers indicate the maximum firing range. Minimum firing range is indicated by a flashing distance line.
- When attacking with gun pods or RB 05 against aerial targets, the line indicates distances measured by the radar. Markers indicate recommended firing range.
- When attacking with illumination bombs, indicates distance to the target. Markers indicate popup distance.
- When attacking with IR missiles (Sidewinders), the line indicates the firing envelope. Line length is a function of distance measured by the radar.

Take-off mode

During take-off, the flight path vector symbol becomes an attitude indicator to help maintain a correct attitude during rotation / initial climb. This is indicated by the absence of the Airspeed Deviation Indicator (“fin”).

The Course scale, Time line and flight path vector are displaced 10° below the horizon.

The Time line expands with increasing airspeed and when the line reaches the markers, the aircraft has reached the recommended rotation speed.

During take-off, if the attitude indicator is on the artificial horizon, a 10° pitch angle is achieved. If the attitude angle is aligned with the top of the pole track a 13° pitch angle is achieved.

When the aircraft attitude exceeds 5° the artificial horizon, Time Line, and Course scale are moved to their normal positions. The Radar altitude index appears. After take-off, the reference altitude is set to 500 metres.

When the aircraft reaches Mach 0.35 or flight path angle exceeds 3° , the take-off mode ends and the normal navigation modes appears. This is indicated by that the appearance Air-speed Deviation indicator.

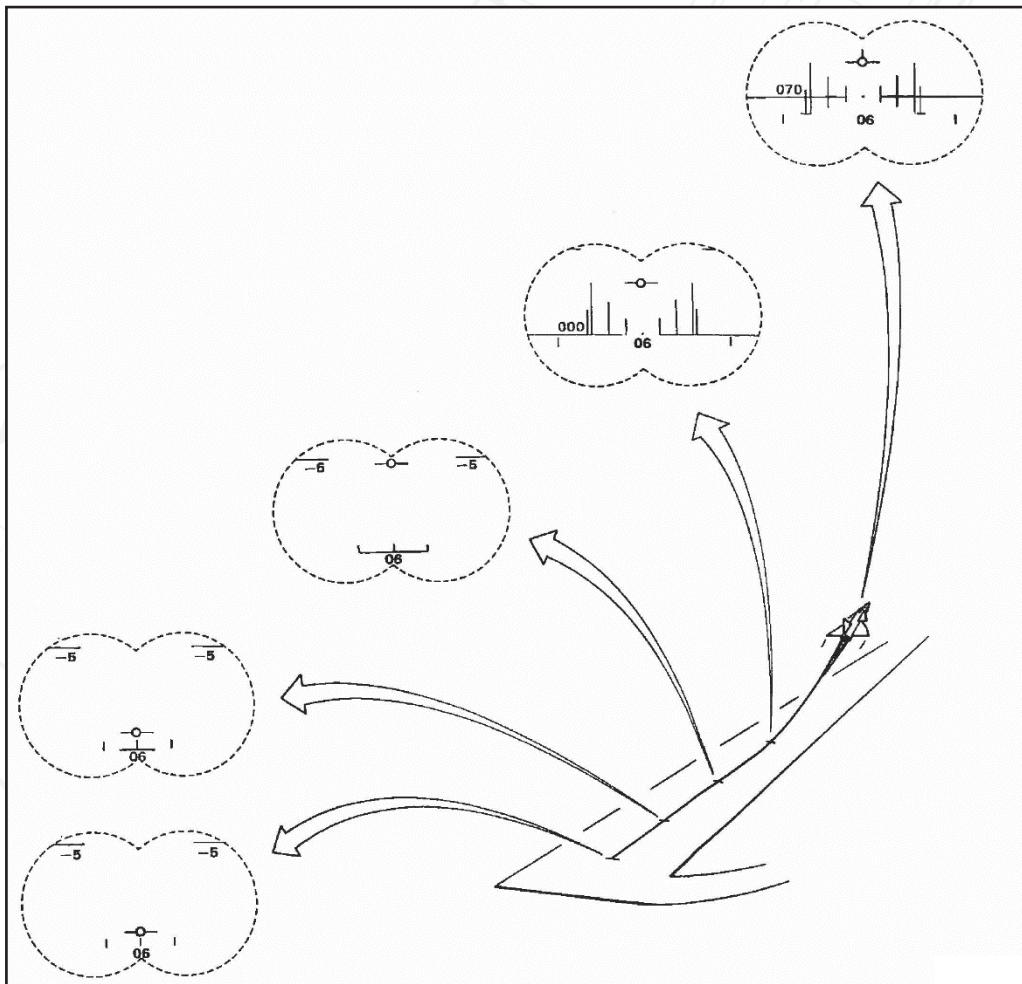

Figure 76. HUD symbology during Take-off mode.

LANDN NAV

Enabled by setting the master mode selector to LANDN NAV.

Used for instrument landings. A glide path line is set at 2.87° below the horizon and represents the recommended glide path. The pole track indicates deviation from the ILS glide slope. As with the navigation mode, the horizontal movement of the glide path line and reticule dot will indicate a commanded turn.

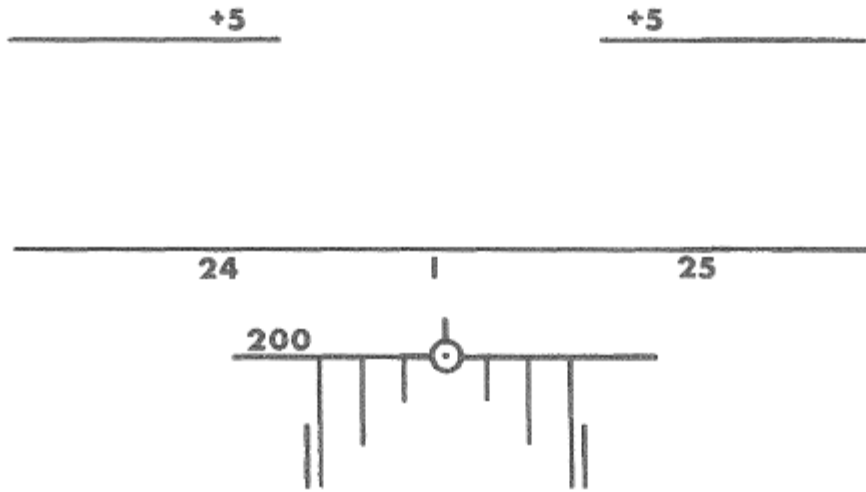

Figure 77. HUD symbology in mode LANDN NAV.

LANDN P/O

Enabled either automatically during the final stage of a normal instrument approach in LANDN NAV, or can be manually by setting the master mode selector to LANDN P/O (PAR or Optical).

Used for visual landings or Precision Radar Approach. Identical to LANDN NAV but without pole track. The horizontal movement of the glide path line and reticule dot will be a commanded turn onto the runway heading. By setting the HUD slave switch (SLAV-SI) to ON (TILL), the glide path line and reticule dot can be locked horizontally to the flight path vector.

Note: When the radar altitude is less than 15 m AGL, the flight path vector changes function to a sink-rate indicator. If the flight path vector is held at the glide path line, the sink rate will not exceed 2.96 m/s. If the radar altimeter is not available, the mode engages at 30 metres altitude.

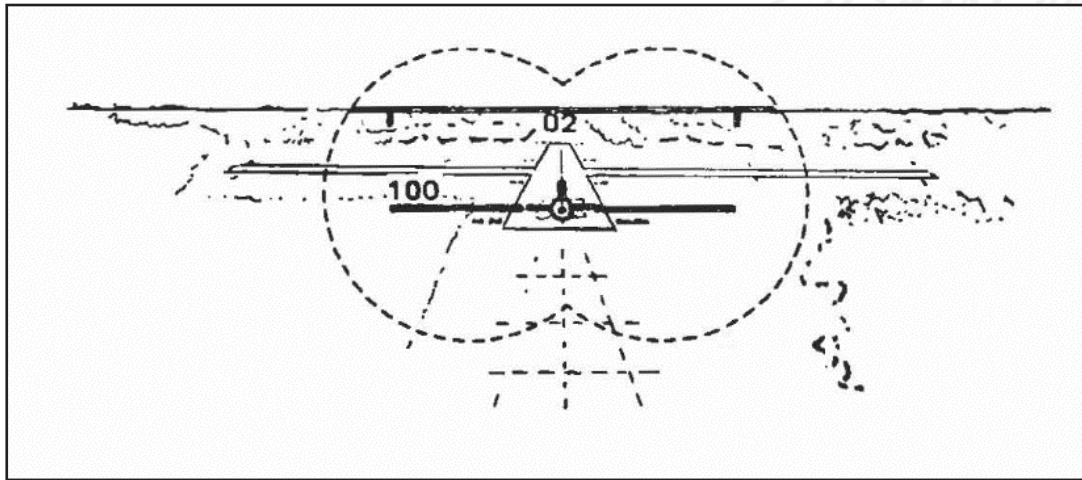

Figure 78. HUD symbology in mode LANDN P/O.

LOW NAV low-level navigation mode

During flight below 100 m, the pilot can set a de-cluttered HUD mode. Only the attitude reference and Flight Path vector remain shown. The LOW NAV mode is enabled if the HUD slave switch (SLAV-SI) is set to ON (TILL).

The Course Scale can be brought up into view by pressing the reference button on the control Stick.



Figure 79. HUD in LOW NAV mode.

Weapons modes

Please refer to the Weapons employment section for further details on specific systems.

Cental Indicator (CI) Symbology

PPI

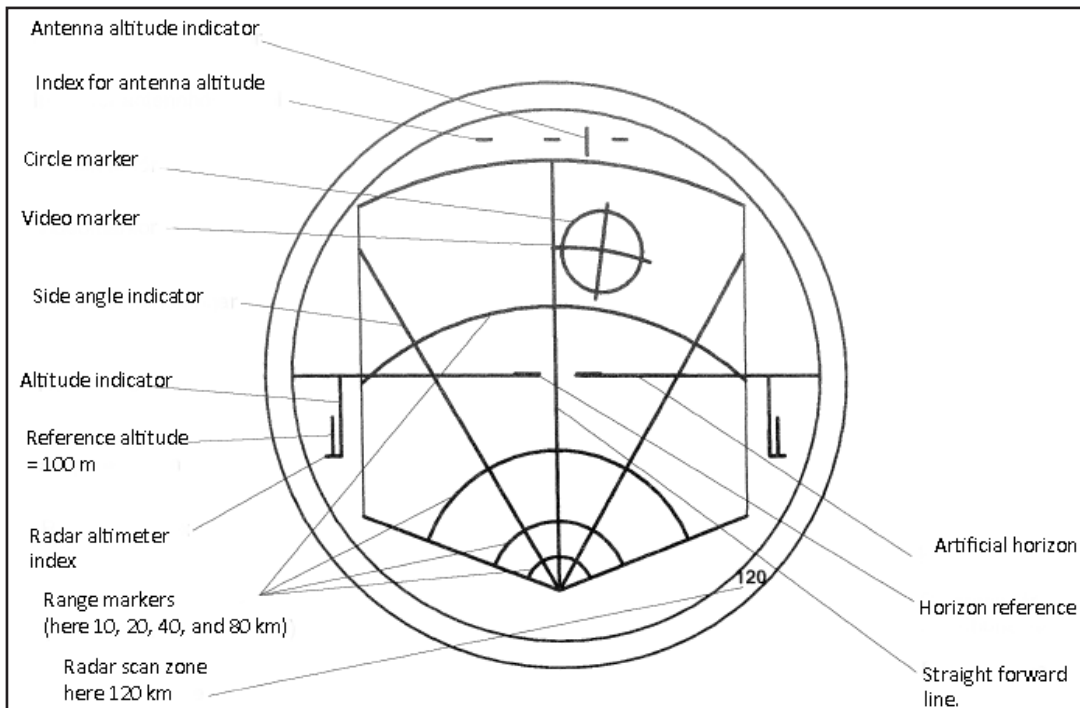

Figure 80. CI symbology in mode PPI

B-SCOPE

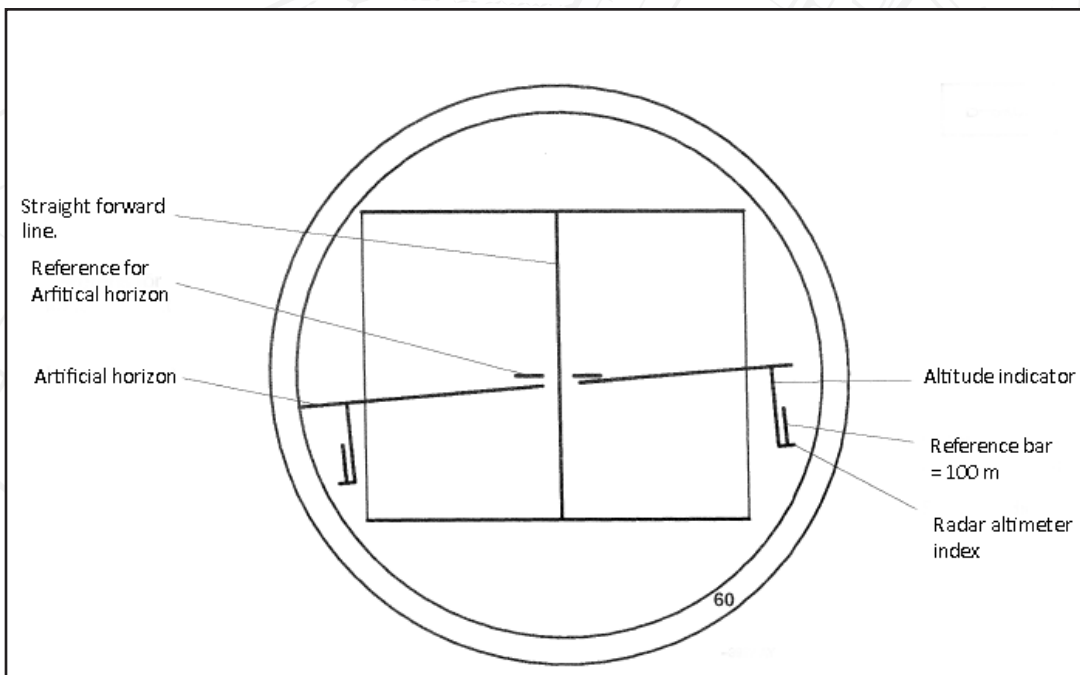

Figure 81. CI symbology in mode B-scope

Radar PS-37/A

The PS-37/A radar is a mono-pulse X-band ground mapping radar. It is designed for targeting ships and in a lesser capacity, aircraft. It can be used against ground targets however the effectiveness is entirely dependent on the contrast to the surrounding area and target size. The radar is also used as a navigational aid and is very closely integrated with the navigation suite.

The radar does not “lock” a target as can be seen on other radar types, but serves to identify the position of terrain features and potential targets. The radar display is mostly unfiltered and will provide a certain amount of “noise”. It is up to the pilot to determine what the radar returns correspond to.

In addition to the search mode, the radar will operate in a ranging mode during certain ground attack and in the Air-to-Air modes in order to increase accuracy of the sighting mechanism.

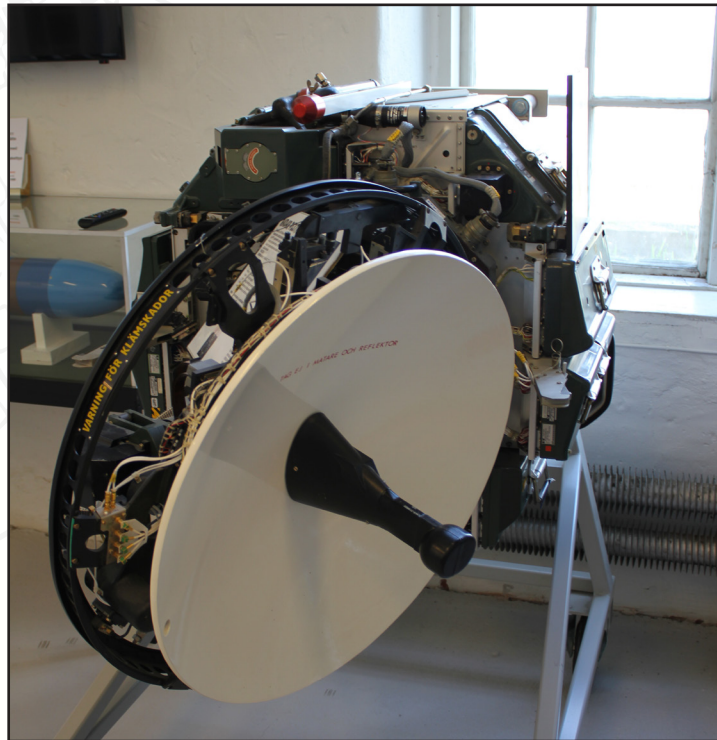

Figure 82. PS-37/A radar.

The radar dish can be rotated in a cone of 65° and the radar is mounted -5.5° of the aircraft X-axis.

	PPI				B-scope	
Scan zone(km)	120	60	30	15	120	60,30,15
PRF (Hz)	475	475	1900	1900	970	1900
Pulse length SHORT (KORT)	2.0	2.0	0.5	0.5	0.5	0.5
Pulse length NORMAL	4.5	3.5	1.0	0.5	0.5	0.5

Antenna elevation and scan zone range

The radar is in most cases automatically steered by the CK37 Flight computer. However, the antenna elevation can during the normal search mode be adjusted $\pm 10^\circ$ from the set angle by use of the antenna elevation potentiometer on the radar control stick. In the Air-to-air search mode a special indicator for the antenna elevation appears above the radar display.

Scan zone range (km)	Flight altitude (m)	Antenna elevation (relative to the horizon) (± 0.5)
15	-	-3.0°
30	> 600	-3.0°
30	< 600	-1.5°
60	> 600	-1.0°
60	< 600	-0.5°
120	-	-0.5°

The antenna elevation equals $+1.5^\circ$ during air-to-air scan and 0° relative to the horizon in terrain avoidance mode.

The antenna is steered directly by the CK37 during Target ranging. The radar is then steered towards where the reticule on the HUD is pointing.

Antenna scan width

The Radar during search mode has two main modes;

The wide program has a $\pm 61.5^\circ$ (from x-axis) wide and 3.6° tall arc with a search speed of $110^\circ/\text{s}$.

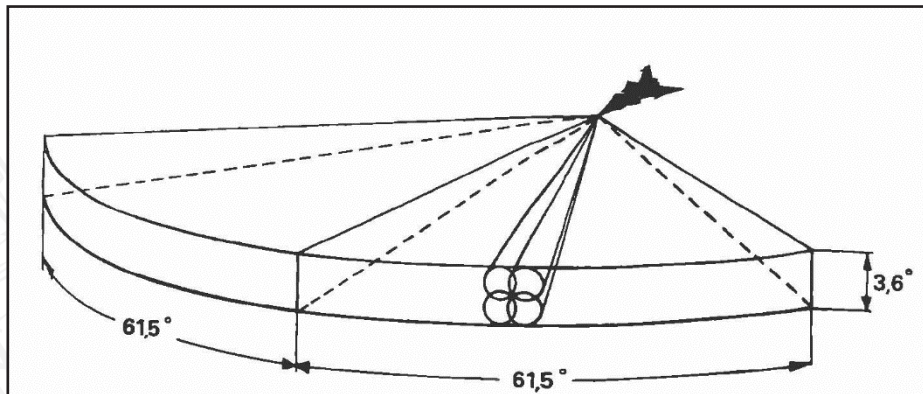

Figure 83. Radar scan width (wide).

The narrow program has a $\pm 32^\circ$ (from x-axis) wide and 3.6° tall arc with a search speed of $60^\circ/\text{s}$.

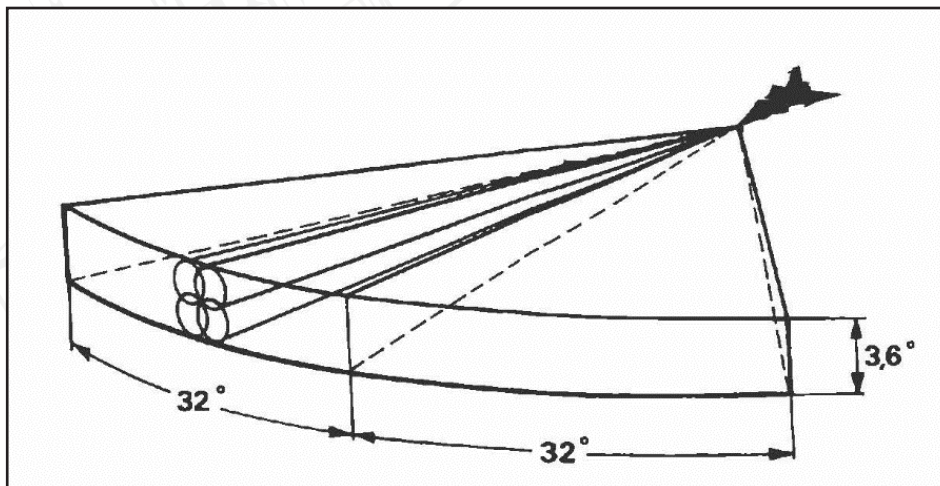

Figure 84. Radar scan width (narrow).

Radar amplification modes

The radar has two main amplification modes which dictate how the contacts are displayed. The modes are toggled with the LIN / LOG switch.

Logarithmic

The Logarithmic mode (LOG on the switch) is the default mode, where the terrain contacts are more nuanced and different terrain types can be discerned.

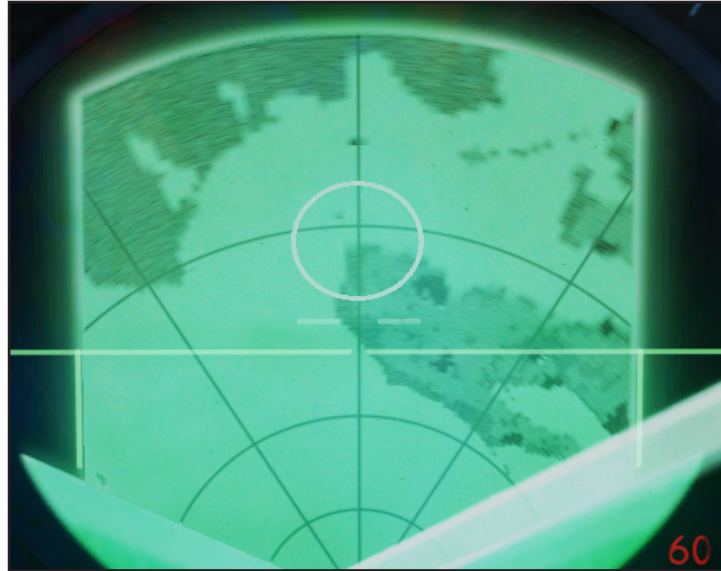

Figure 85. Radar in logarithmic mode.

Linear

The linear mode (LIN on the switch) is the high contrast mode where the difference between terrain types and elevations are not as important, such as during terrain avoidance or in Air-to-Air modes.

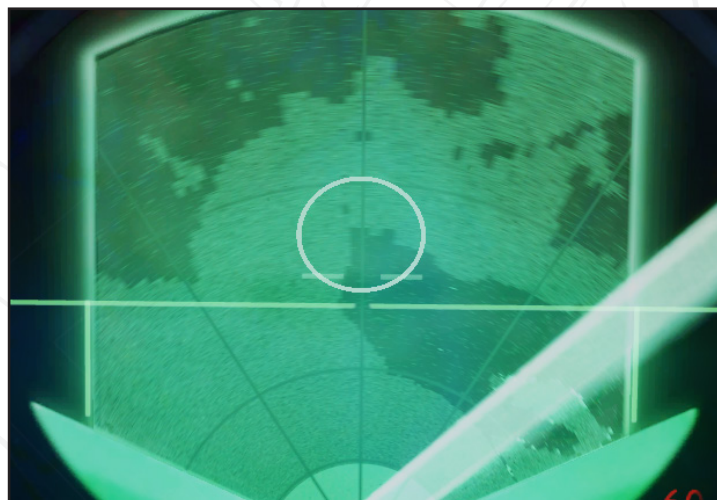

Figure 86. Radar in Linear mode.

The overall amplification gain for both modes can be adjusted with the MKR / Radar gain knob on the front of the radar stick base. It has a centre snap position that is for good detection of naval contacts.

Radar control overview

3

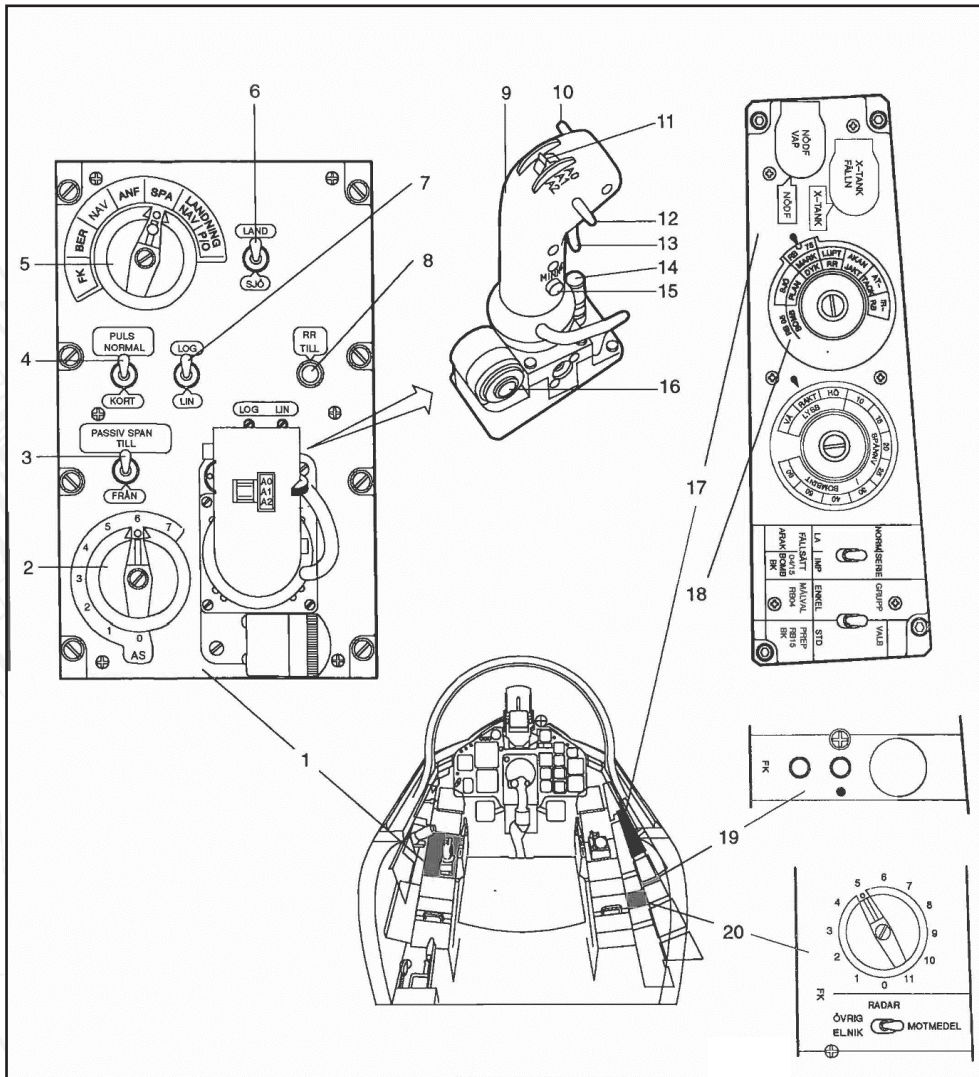

Figure 87. Radar controls overview.

- | | |
|---|---|
| 1. Radar panel with radar control stick | 11. Radar mode selector |
| 2. AS-mode selector | 12. Radar scan zone selector |
| 3. Passive radar mode selector | 13. Fix trigger |
| 4. Pulse length selector | 14. MKR (radar gain) dial |
| 5. Master mode selector | 15. Memory mode selector |
| 6. LAND / SEA radar altimeter mode (LAND/SJÖ) | 16. Antenna altitude dial |
| 7. Linear / Logarithmic receiver mode. | 17. Weapons panel |
| 8. Circuit breaker RR TILL (no function) | 18. Weapons selector |
| 9. Radar Control stick | 19. Function check mode indicator (no function) |
| 10. Terrain avoidance mode selector | 20. Function check mode selector (no function) |

Radar controls

AS-mode selector: Toggles anti-jamming filters. (No Function)

Passive radar mode selector: ON / OFF. Toggles passive search.

Pulse length selector / PULS/ NORMAL KORT: Toggles pulse length to compensate for brief returns.

Master mode selector:

BER, radar off, but pre-warmed.

NAV, Radar display possible, but only after 180 seconds after main generator comes online. Search mode.

ANF: Radar function dependent on selected weapon.

SPA/ LANDN NAV/ LANDN P/O. Same function as NAV.

LAND / SEA (LAND / SJÖ):Changes the signal modulation on the radar altimeter. (No function)

LIN/ LOG: Selects Linear or logarithmic processing of the radar receiver.

RR TILL: No function. Used to override electrical errors.

Radar control stick: Used to move radar cursor (or Cross / circle markers)

Terrain avoidance mode switch: Enables Terrain Avoidance mode, reset when radar is set to A0

Radar mode selector: Three position switch on top of radar control stick.

A0: Switch forward. Radar off.

A1: Switch in middle position. Radar On. Wide search mode with Sector PPI

A2: Switch aft. Radar on. Narrow Search. B-scope

Radar range selector: Increases / decreases radar scan range. Range indicated on bottom of Central Indicator.

Fix trigger: Used for taking fixes (Visual or radar-based) as well as locking targets during Air-to-Air use.

T0: Neutral position

T1: First trigger detent (rebounding to T0)

TV: Second trigger detent (rebounding to T0)

Memory picture switch: Turns radar antenna off but saves current radar picture. Memory mode will reset when radar mode switch is moved to A0 or A2 or enabling Terrain avoidance mode.

Antenna elevation potentiometer: During search modes, the antenna can be steered in elevation slightly. Has a middle “snap” position.

MKR / Radar gain potentiometer: Regulates the amplification gain of the radar. Has a centre “snap” position for the best contrast against naval contacts.

Radar setting controls.



Figure 88. Additional radar controls.

Radar brightness (LJUS RADAR): Adjusts the general brightness of the radar display.

Note: The radar is automatically turned off when the nose-gear is depressed (aircraft is landed).

Terrain avoidance mode



Figure 89. Terrain avoidance mode

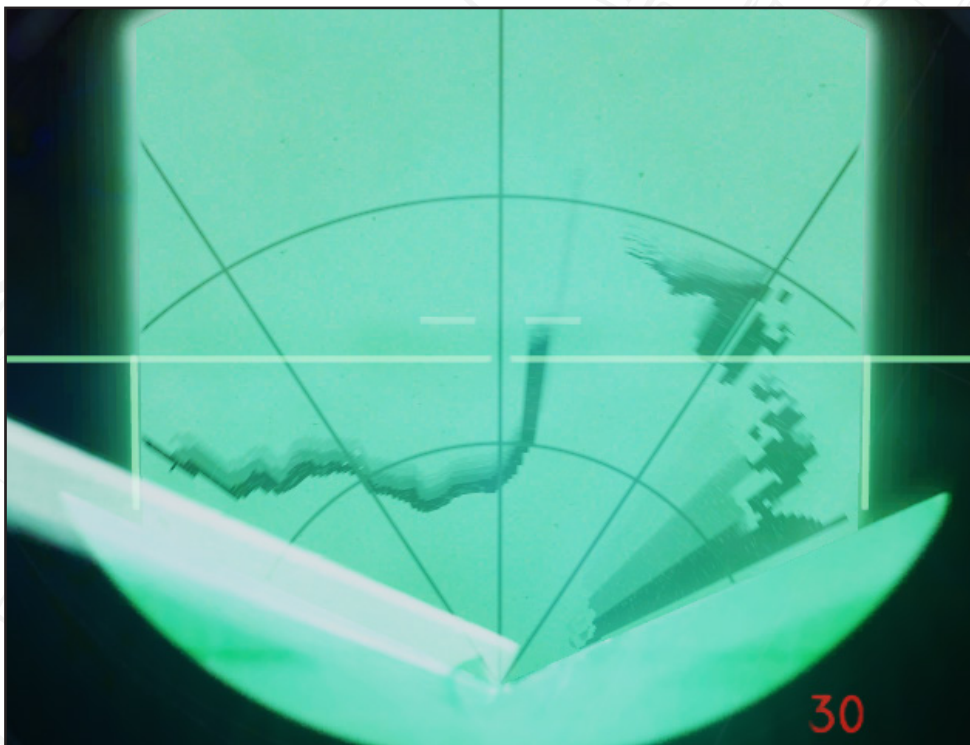

Figure 90. Radar Terrain avoidance mode.

The terrain avoidance mode is designed to allow flight at low altitudes in poor visibility. On engaging the mode, the radar antenna will be set to 0° relative to the horizon (assuming the antenna altitude potentiometer is set to the middle position) and the antenna beam will be narrow in altitude. This results in the radar only displaying radar returns at the same altitude as the aircraft. The negative space thereby will be obstacle-free.

For example, a canyon would be similar to that of a corridor, with sharp returns on either side, and clear space inbetween. In the picture above there is a mountain about 5 kilometers away, with a clear path in the right, along with some mountain tops farther away.

If the radar is set to B-scope, the narrow search program is used. The B-scope displays the area 1000 m – 10 km ahead of the aircraft.

The terrain avoidance mode is disengaged when the radar mode selector is set to A0, so that switch between PPI (A1) and B-scope (A2) can be made without disengaging the terrain avoidance mode.

Passive scan mode

If the radar is in mode A0, the radar display is turned off. The CI symbology can be displayed if the Passive search mode switch PASSIV SPAN is set to TILL (on). The radar receiver scans in a wide search mode. The antenna altitude is set according to the selected scan zone range. The radar will receive active jamming signals and display the direction from where they are received, but will not emit anything itself.

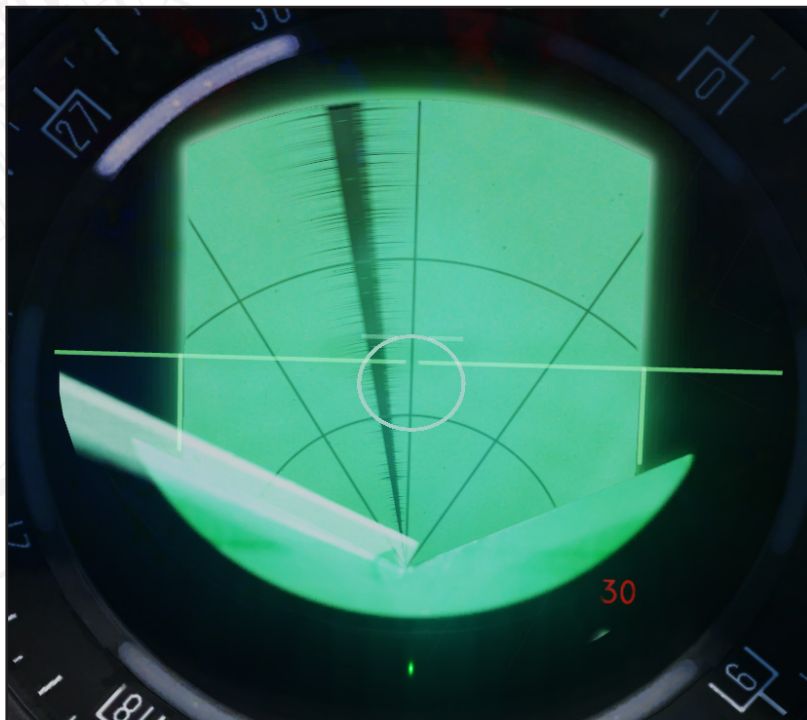

Figure 91. Radar in passive scan mode.

Memory mode

When pressing the memory mode button, the radar transmitter will cease to transmit and the current radar picture will be frozen. The displayed picture will last about 30 seconds. The normal radar functionality will return if the radar mode selector is set to A0 or A2, or if the terrain avoidance mode button is pressed. The memory mode is used in case you want to study the radar picture, but do not want to keep transmitting radar signals.

App-27 RWR and countermeasures systems

App-27 Radar Warning receiver (RWR)

The APP-27 Radar Warning Receiver (RWR) System is designed to alert the pilot of being illuminated or locked on by a radar and thereby warn of potential threats. The RWR receivers are fitted on the leading edge on both of the main wings and a rear receiver mounted on the boom above the ejector.



Figure 92. RWR display. Receiving radar signal from 11 o'clock or between 260° - 320° bearing

There are two main components to the RWR warnings. The first is a ring of lights around the radar display on the Central Indicator. Each of the six lights indicate a detection "lobe" around the aircraft. Each lobe is approximately 60°. As such, if the light at the 2 o'clock position is lit, the radar is detected from the front right lobe. As the course ring is mounted around the indicators, it is simple to not only detect the direction of the signal but also the rough bearing towards it.



Figure 93. RWR modes.

The second component is the audio warning. The signal received is translated to a certain tone. The tone is the Pulse Repetition Frequency of the received radar signal in hertz.

For example, a signal received with a PRF of 1500 Hz will yield a tone of 1500 Hz, and so on up to a certain PRF value. Very high PRF are instead warned by a special tone, alternating between 1000 and 2000 Hz.

Given the lack of the system to classify the radar, the classification is up to the pilot to determine the radar type. A general rule of thumb is that a higher PRF is more likely to be a tracking rather than search radar.

The RWR has 3 operating modes. The modes are operated by a three-position knob on the right side console.

OFF (FRÅN): RWR is off and will not provide any warnings.

LIGHTS (LJUS): Visual warning only. Audio warnings muted.

LIGHTS / AUDIO (LJUS / LJUD): Visual and Audio warnings.

The volume is controlled by the UK DÄMPNING knob on the left vertical panel.



Figure 94. RWR (Master volume) control

KB countermeasures pod



Figure 95. KB pod

The KB countermeasures pod provides chaff and flare deployment capabilities for the AJS-37. The KB pod contains both chaff and flares in separate sections of the pod. Since the pod can only be mounted on the inner wing pylons, the aircraft likely has to sacrifice some offensive weaponry in order to provide countermeasures capabilities. The pod can be carried on either wing, or both at the same time.

Flares are designed to disorient heat-seeking (IR) missiles and equipment, and chaff is designed to confuse radar emitters and radar guided missiles.

The KB pod contains 36 flares and a large amount of chaff.

Operation

The pod can be used in either the automatic or manual mode. Operating two pods is identical to operating a single.

Manual mode

Chaff can be released in one of 4 programs:

Chaff program 1 (P1) Rapid release

Settings:

Mode selector KB in mode 1.

Chaff / flare selector in mode R or R+F.

Streak selector in mode 0. KB release switch (on canopy frame) in mode OFF (FRÅN)

Initiation and Function:

When the KB release switch (on canopy frame) is set to INT (Interval) or KONT (Continuous), chaff is dispensed rapidly.

Total release time: 1.5 minutes. Both pods release in parallel.

Chaff program 2 (P2) Medium release

Settings:

Mode selector KB in mode 2.

Chaff / flare selector in mode R or R+F. Streak selector in mode 0.

KB release switch (on canopy frame) in mode OFF (FRÅN)

Initiation and Function:

When the KB release switch (on canopy frame) is set to INT (Interval) or KONT (Continuous), chaff is dispensed rapidly with intervals of 2 s release and 2.5 s pause. Interval is repeated as long as the KB release switch is either held in INT (intervals) or KONT.

Total release time: 3.5 minutes. Both pods release in parallel.

The P2 program is used by default when using the quick release function.

Chaff program 3 (P3) Slow release

Settings:

Mode selector KB in mode 3,

Chaff / flare selector in mode R or R+F. Streak selector in mode 0.

KB release switch (on canopy frame) in mode OFF (FRÅN)

Initiation and Function:

When the KB release switch (on canopy frame) is set to INT (Interval) or KONT (continuous), chaff is dispensed slowly (1/5th of the speed of program 1).

Release switch is either held in INT (intervals) or KONT (continuous).

Total release time: 8 minutes. Both pods release in parallel.

Chaff program 4 (P4) Slow streak release

Settings:

Mode selector KB in mode 3.

Chaff / flare selector in mode R or R+F. Streak selector in mode 0.

KB release switch (on canopy frame) in mode OFF (FRÅN)

Initiation and Function:

When the streak selector is set to mode 4, the pods begin to dispense chaff slowly (1/5th the speed of program 1). If any of the other chaff programs is needed during the release streak, the program 4 is inhibited. The streak can be renewed if the streak selector is cycled (mode 4- 0 -4)

Release switch is either held in INT (intervals) or KONT.

Total release time: 8 minutes, 16 minutes if two pods are carried. The left pod will empty before the right pod begins to dispense chaff.

Quick release

The quick release will supersede all other ongoing programs. The previous program will resume after completed quick release, with exception of chaff program 4.

Note. Flares can only be released via the quick release mode.

3

Settings:

KB mode selector: Desired position.

Chaff / Flare selector: in desired position. R: Chaff only, R+F: Chaff and flares, F: flares only.

Streak selector: Desired position

KB release switch: Desired position.

Initiation and operation:

Chaff and/or flare release is initiated by pressing the countermeasures quick release button on the throttle. Release in continue until the button is pressed again. Beware, the pod will empty rather quickly if release is not cancelled. The indicator light MOTVERK will appear on the right indicator table during release.

The release mode depends on the setting of the chaff / flare selector:

In mode R, chaff is dispensed according to program 2 (P2).

In mode R+F, chaff is dispensed according to program 2, with a single flare every other second.

In mode F, flares are dispensed every other second.

The chaff release will last for 3.5 minutes and the flares for 72 seconds during the quick release.

Automatic mode

The Radar warning receiver APP-27 will initiate chaff release when a radar lock is detected.

Using the integrated RWR (APP-27)

Settings:

KB mode selector in mode A (automatic).

Chaff / flare selector in mode R or R+F.

Streak selector in mode 0

KB release switch:

- OFF (FRÅN) – Automatic chaff release disabled
- INT or KONT – Automatic chaff release enabled.

Initiation and operation:

When the radar warning receiver detects a radar lock in targeting mode, chaff is dispensed in program 2. Chaff release continues until the radar stops tracking or the KB release switch is set to mode OFF (FRÅN)

Using the U22 or U22/A

Settings:

KB mode selector in mode A,

Chaff / flare selector in mode R or R+F.

Streak selector in mode 0

KB release switch: KONT

Initiation and operation:

The RWR-capabilities of the U22 or the U22/A ECM pods will dispense chaff in program 1 (rapid release) if detecting continuous wave radar signals such as active missiles or other high power emitters. Release is indicated by the MOTVERK light on the right indicator panel when either the U22 pod is emitting and / or countermeasures are released by the KB pod.

The pod cannot be jettisoned.

Indication

During either manual or automatic chaff release, the MOTVERK (countermeasures) light appears on the right indicator panel.

When 10% of the chaff load remains the KB V SLUT (left KB empty) and / or KB-H/ KA SL (right KB empty) flashes on the right indicator panel, and will be lit when fully empty of chaff.

When 10% of the flare load remains (4 flares) the FACKL SL (Flare empty) flashes, and will be lit when the pod is fully empty of flares.

Flashing indication is cancelled by pressing the master caution reset button.

U22 or U22/A ECM pods

The U22 and U22/A pods are the electronic countermeasure (ECM) or “jammer” pods designed to interfere with hostile radar systems to inhibit tracking and locking functions for self-protection purposes. The pods cannot be jettisoned. The pods are of a repeater type, meaning that they will only emit when receiving a signal, thereby operating largely automatically.

The ECM pods exist in two versions. U22 (previously called KA) is the older pod with only ECM features. U22/A is a more recent (mid 1990's) update with a more modern cooling system as well as various improvements such as limited electronic intelligence (ELINT) gathering.

The U22 pods are directional in their emission envelopes, the pod can emit in a cone of $\pm 60^\circ$ gyro stabilised horizontally and about $\pm 45^\circ$ vertically.

U22 ECM pod

Settings:

OFF: Mode 0

Automatic: Mode A

Standby (pre-heat): Mode B

The other positions of the U22 mode selector are not used on the older U22 pod.

Initiation and operation:

The pod requires 3 minutes of pre-heating in mode A or B before it can start emitting. With the mode selector in mode A, the pod will automatically emit when illuminated by a radar from the frontal aspect.

Indication

During emission, the MOTVERK indicator light appears.

If a fault occurs in the pod, the indicator KB-H/KA SL light flashes. This warning is cancelled by pressing the master caution reset button. Doing so will automatically attempt a restart of the pod.

U22/A ECM pod

The U22/A is a slightly improved version of the U22 pod, with expanded capabilities:

- New cooling system.
- Added data cartridge.
- Increased sensitivity.
- **Silent recording functionality for electronic intelligence (ELINT) purposes.** The pod will record incoming radar signals which can be used to determine the type and position of emitters via triangulation.

The U22/A is operated on the same panel as the U22 pod.

Resulting mode	U22 mode selector mode	U22 bandwidth selector mode
Off	0	No function
Preheat	A	F
Silent recording	A	G H J K
Active emission	B	F G H J K
Active emission	D	F G H J K
Active emission	E	F G H J K

Settings:

- OFF: **Mode 0** Pod is disabled
- Preheat: **Mode A/F** Pod is being preheated and prepared for use.
- Silent recording: **Modes A/G - A/K** The pod will receive and record incoming signals, and will **not** emit any jamming signals.

Mode A/G: Low sensitivity.

Mode A/H: High sensitivity.

Mode A/J: High sensitivity.

Mode A/K: Automatic sensitivity cycling between mode A/G and A/J.

- » Active jamming **modes B/F- E/K**
Pods will automatically emit when illuminated by a radar from the frontal aspect.

For further details on the ELINT use, please refer the relevant appendix.

Indication during silent recording

Visual:

Indicator light MOTVERK flashes on the right indicator table. It flashes with 8 Hz if receiving a CW (continuous wave, likely an active radar missile) or other high power emitter. It will flash with a frequency of 4 Hz if any other signal with a lower PRF is received.

Audio:

Three types of sound cycles are used.

1 second tone, 1 second silent: Likely a search radar

3 tones per second, 1 second silent: Likely targeting radar

5 tones per second: CW or high power radar.

3

Countermeasures controls overview

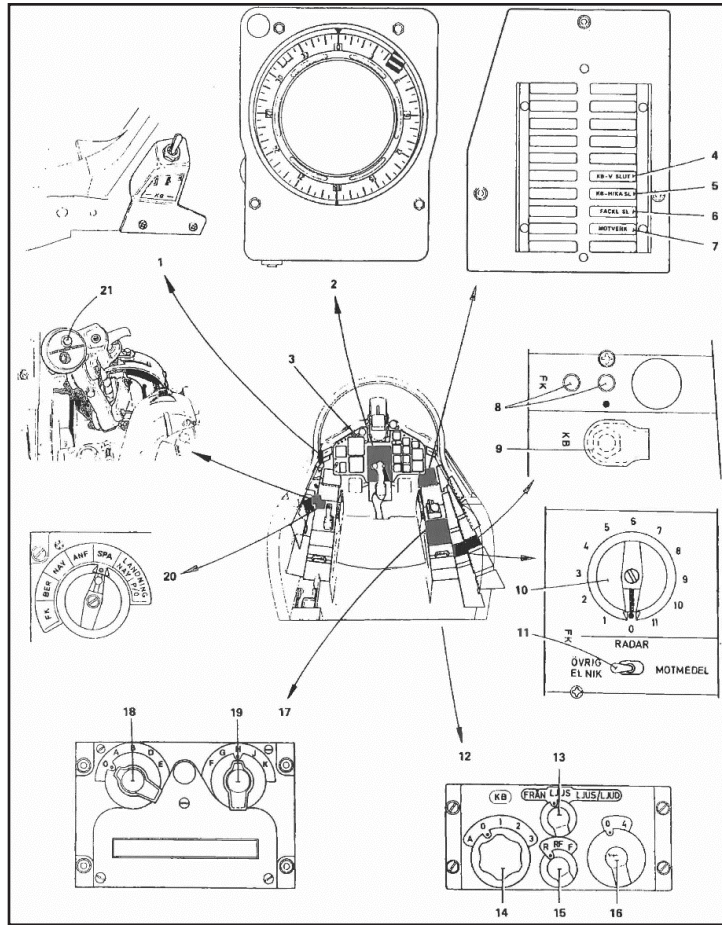

Figure 96. Countermeasures controls overview.

- | | |
|--|---|
| 1. KB release mode switch on canopy frame | 11. Function check selector (no function) |
| 2. App 27 indicator | 12. KB control panel |
| 3. Master caution cancel | 13. App-27 RWR mode selector |
| 4. Left KB pod empty indicator light (KB-V SLUT) | 14. KB mode selector |
| 5. Right KB pod empty indicator light (KB-H / KA SL) | 15. Chaff / flare selector |
| 6. Flares empty indicator light (FACKL SL) | 16. KB streak selector |
| 7. Countermeasures indicator light (MOTVERK) | 17. U22 panel |
| 8. Function check (no function) | 18. U22 mode selector |
| 9. KB switch, nose-gear bypass (KB) | 19. U22 Bandwidth selector |
| 10. Function check selector (no function) | 20. Master mode selector |
| | 21. Countermeasures quick release (on throttle) |

Navigation system (ADR/TILS/TERNAV/ Doppler)

The AJS-37 Viggen is equipped with a rather advanced (for its time) navigation system. The system is based on the principle of Automatic Dead Reckoning (ADR). By inputting the origin point (the take-off position), course, airspeed and attitude, the current position can be established.

ADR principle

The initial position is entered into the system, and from this a three-dimensional vector is created based on flight data from the Flight Data Unit (main pitot), attitude, course, and airspeed. Inputs from the accelerometer unit are taken into account in order to refine the information coming from the flight data unit. The drift due to wind is compensated by either adding pilot entered (forecast) wind values or the movement detected by the Doppler unit.

Calculation

Every 103 ms the calculated vector is used to calculate change in the ground-referenced speed. This change in motion along the ground is added to the entered take-off coordinates and will continually update this position during the flight. This is known as the basic position, which is the basis of the navigation system.

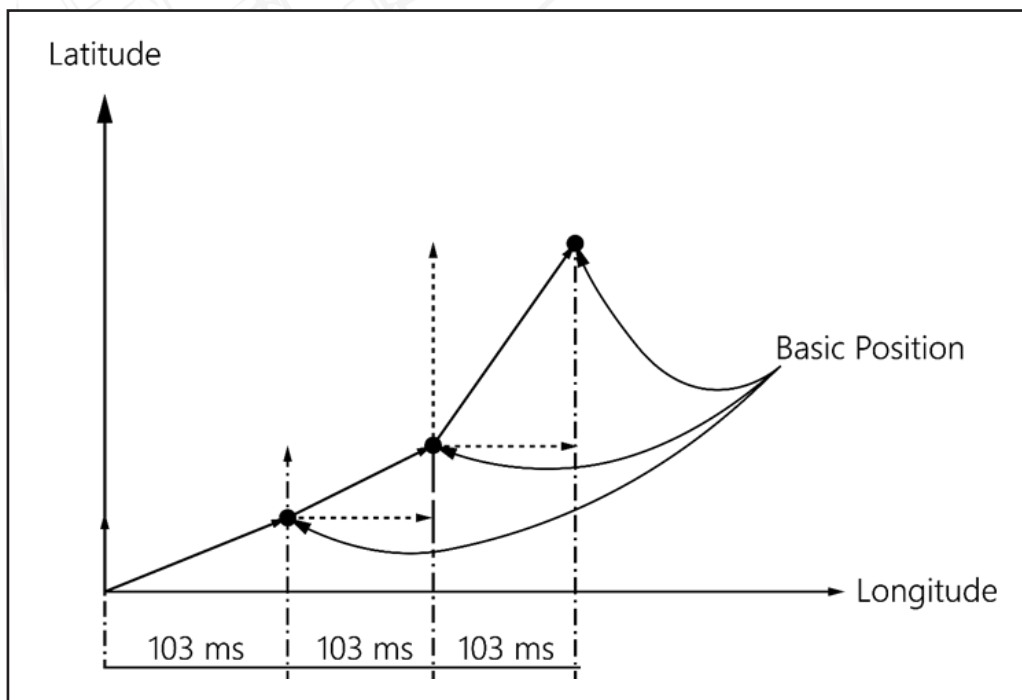

Flight plan & Waypoint types

The aircraft can use a number of different types of entered coordinates.

LS. The take-off airfield.

B1-B9 are normal navigation points that constitute the navigation polygon and the planned flight path.

L1: Primary landing field. Default to be same as LS.

L2: Secondary landing field.

BX: Mark points outside the navigation polygon. Mark points will not be added to the fuel and time calculations and only serve as reference points.

M: Target points. Assumed target position. Any waypoint can be changed to a target point. Will be indicated in the HUD in certain modes and can be used for weapon delivery. For example, if waypoint B5 is set to a target point, it becomes M5.

U: Pop-up position. A position set relatively to the target position. Entered as the distance from the popup position to the target. Used to plan approach against a fixed target or area.

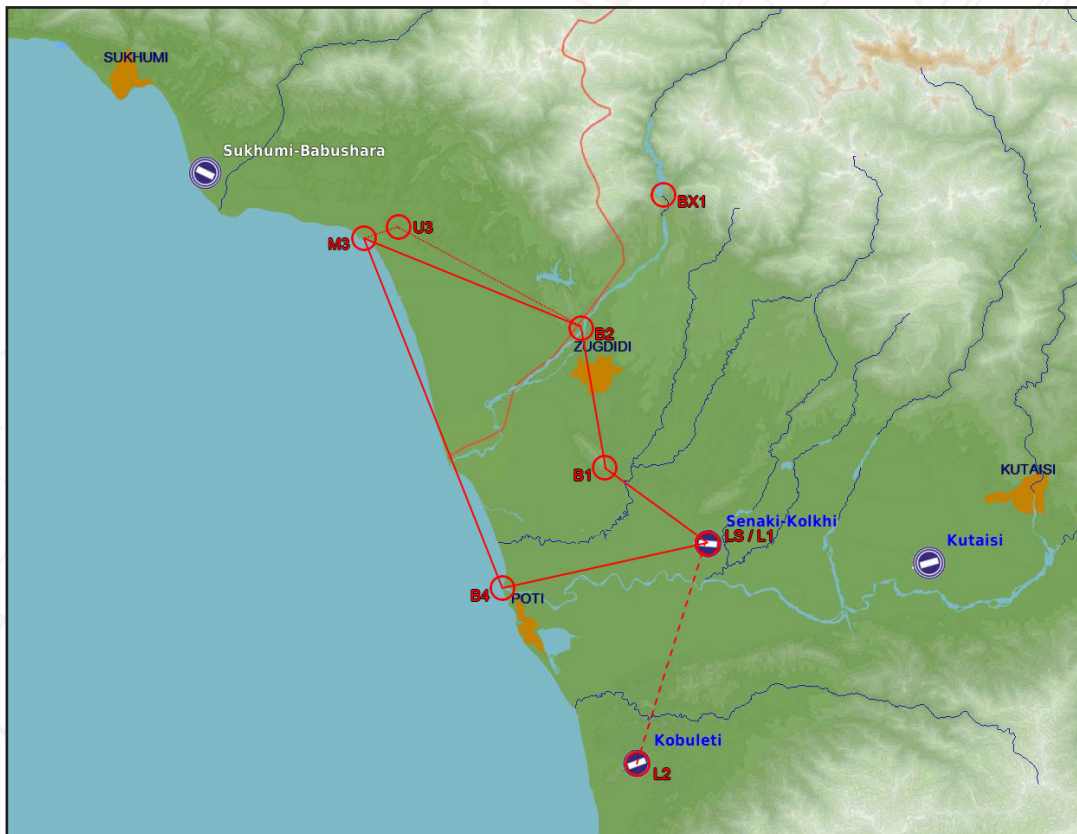

Figure 97. Typical flight plan with 4 waypoints (with a target point M3 assigned). Mark point BX1 added and the optional pop-up point attached to Target point M3 (U3). LS being the starting airfield and the primary landing base (L1) and the secondary landing field (L2)

Coordinates will automatically be added from the data cartridge once loaded if available.

Please refer to the procedures section for details on how to enter coordinates

The reference numbers are listed in the in-game kneeboard.

Automatic and manual initial course

In order to determine the current course of the aircraft and all subsequent movements of the aircraft, the system requires an initial course.

Automatic

During take-off (between the intervals of 110 – 200 km/h) the computer compares the course servo with the entered runway heading. In case of a deviation from this heading, an average of the course indication from the Attitude Director Indicator (ADI) is immediately added, resulting in correct course. This is indicated by the Course scale in the HUD moving slightly due to the correction. The course correction servo is connected and is indicated by the course ring on the Central Indicator and the Attitude director indicator (ADI) rotating. After the initial course setting the magnetic course servo which had been connected since the ADI fast erect on start-up, is disconnected.

If the angle difference between the entered runway heading and the ADI (FLI) course angle during the take-off roll is more than 15° the computer will compare it to the opposite runway heading, or if the take-off base has been defined by a reference number, the other possible runway directions on that base. If a runway heading is found, that one is used for the heading correction.

If no runway heading is found, due to a large indication error or because the wrong runway heading / base has been entered, no initial course setting will occur. This is indicated by the warning light NAV SYST.

Manual

The automatic setting can be overridden by pressing the reference switch on the control stick after the aircraft has been carefully aligned with the runway. The computer will use the difference in angle between the entered runway heading and the course angle from the ADI (FLI) for correcting the heading. This can be repeated until a satisfactory result is obtained. The computer will conduct the same checks in regards to the runway heading as with the automatic course setting.

This is used for take-offs on slippery runway and / or with a strong crosswind.

Please refer to the “Manual initial course setting” section of the procedures section.

Manual / automatic selected waypoint change

Automatic waypoint change

The system will automatically select the next waypoint when the active waypoint is overflown or passed within a distance of 3 km. During modes ANF (attack) and SPA (Reconnaissance) or NAV with the trigger safety off (mode unsafe), this automatic switch is locked. Automatic switching does not apply for BX or landing waypoints.

The first waypoint (B1) becomes the destination (active waypoint) automatically after take-off when the aircraft reaches Mach 0.35. This does not apply if the aircraft takes off immediately (without switching to BER) after landing.

Manual waypoint change

If AKT POS is selected on the data selector rotary, manual waypoint change can be used. Any of the waypoint buttons (B1-B9, BX, LS, and L/MÅL) can be used to change to that waypoint.

If no coordinates are set for that waypoint, the coordinates will be copied from the previous waypoint. If L1 has no set coordinates, they will be the same as LS (the designated take-off base).

Navigation instruments and indicators

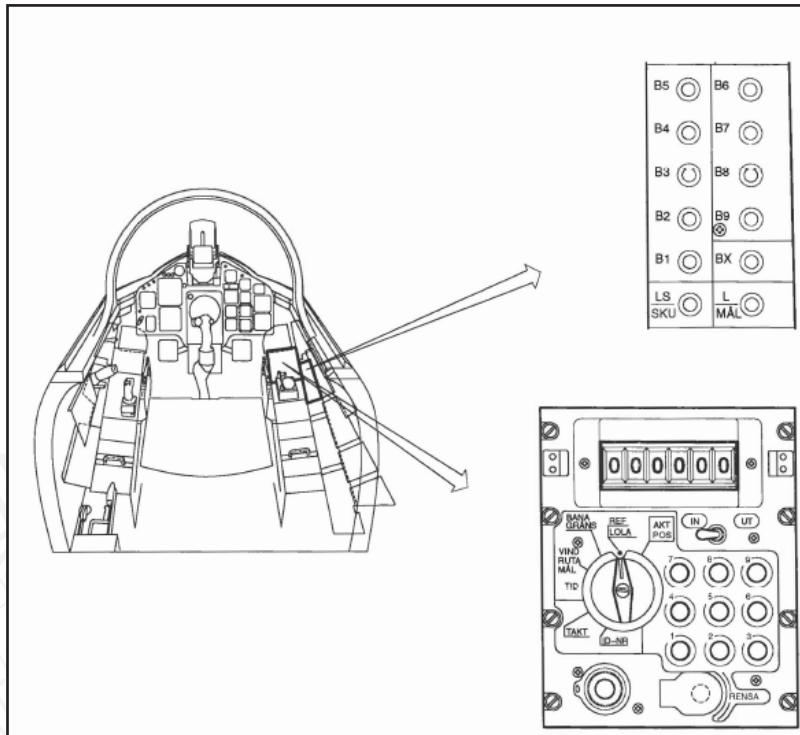

Figure 99. Data panel and navigation panel.

Data panel

The Data panel is the main input / output device for the aircraft's computer. The data panel consists of a data mode selector rotary, a 0-9 keypad, and IN/OUT switch, as well as a display unit capable of displaying up to six digits.

Please refer to the CK37 section of the systems overview for further information regarding the Data panel. Refer to the navigation section or other relevant sections of the procedures chapter for instructions of use.

Data selector modes:

- **AKT POS:** Shows current position (UT/ OUT only).
- **REF LOLA:** Used to input reference number or Longitude / Latitude coordinates.
- **BANA / GRÄNS:** Runway headings and TILS channels. Used to set boundaries for waypoints.
- **VIND / RUTA / MÅL:** Wind direction and strength for entered wind. Selection between Doppler-derived wind and entered forecast wind. Positions of corner points for reconnaissance squares.
- **TID:** Current time, Time on Target. Ingress Mach number. ' reconnaissance fixes.
- **TAKT:** Mission data, fuel reserve, defining target waypoints and pop-up points. Stand-off data. TERNAV on / off. Used to define certain system settings.
- **ID-NR:** Identification number. Readout of reconnaissance data. Readout of addressed data.

Navigation panel

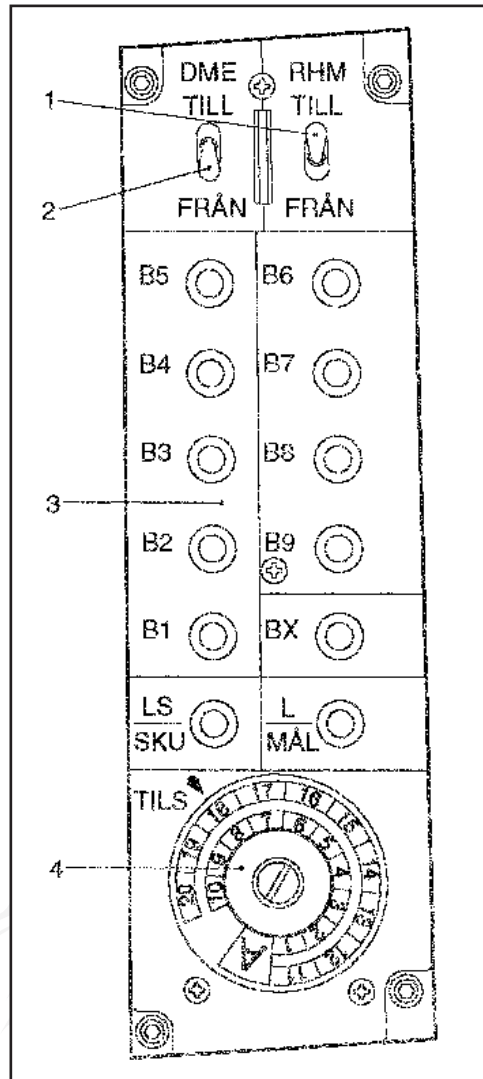

Figure 100. Navigation panel.

1. RHM switch: Toggles Radar altimeter on / off.
2. DME TILL / FRÅN: No function in the AJS, legacy switch.
3. Waypoint selectors: Used to either select a waypoint or readout the saved coordinates.
 - » B1 – B9: Normal navigation waypoints.
 - » BX: Selects a BX point (BX1-9) in combination with the data panel keypad.
 - » L/MÅL: Landing base or reconnaissance target.
 - » LS / SKU: Take-off base or tracked target (reconnaissance).
4. TILS Selector rotary: Selects a TILS channel manually if not entered into the computer.

Navigation indicators

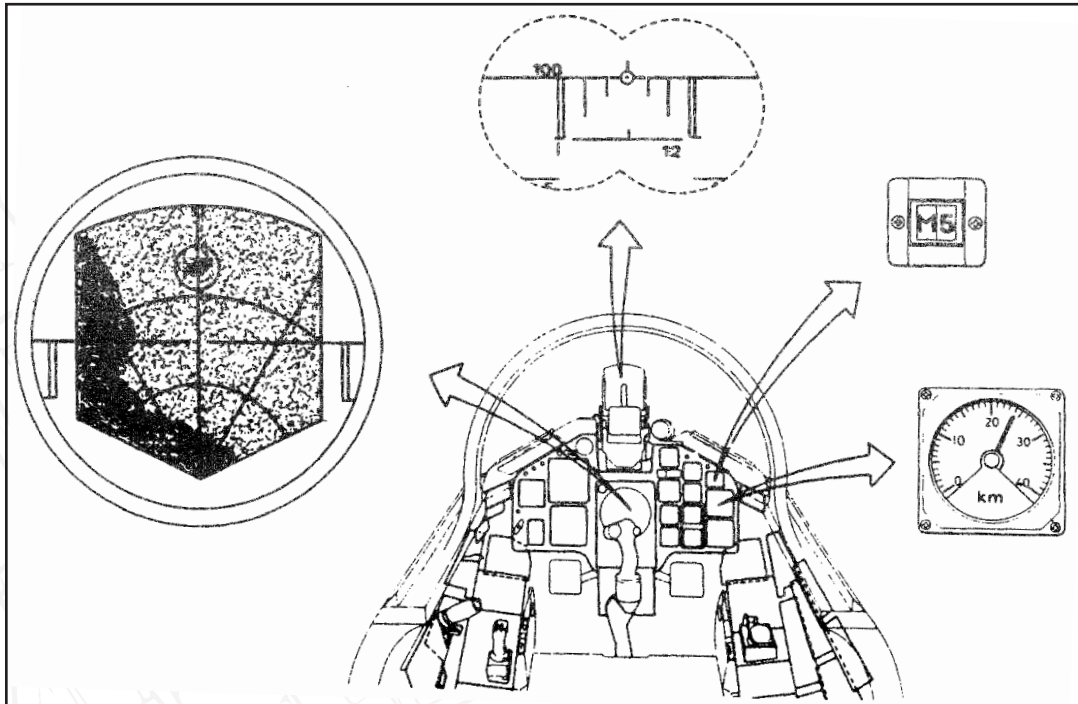

Figure 101. Navigation indicators.

Destination indicator

Indicates distance from the current destination. The scale is either 0-40 km or 0-40 Swedish miles (1 Swedish mile = 10 km). On exceeding 40 km the, indicator rescales to miles (40km becomes 4 miles).

Radar display and Course ring with course index

The radar displays the current destination waypoint as a circle. If the waypoint is outside the radar's area of coverage, the ring will be "parked" against the frame indicating the direction of the waypoint. Distance can be estimated with the set scan range and range markers.

The course ring indicates the current heading on the 12 o'clock position. The entire ring will rotate during a heading change. The course index indicates the course commanded by the navigation system.



Figure 102. Radar in PPI, 30 km scan zone. Current heading 337, commanded heading 340. Waypoint on an island in the river approx. 27 km away.

Waypoint types and Destination Indicator

The destination indicator (top right front panel) displays the current destination (active waypoint). The first digit indicates the destination type and the second indicates the number.

Function	1st digit	2nd digit
Take-off base	L	S
Primary landing base	L	1
Secondary landing base	L	2
Alternate / Reciprocal heading primary landing base	L (Flashing)	1
Alternate / Reciprocal heading secondary landing base	L (Flashing)	2
Landing waypoint (TILS) Primary	LB	1
Landing waypoint (TILS) Primary	LB	2
Touchdown point Primary base	LF	1
Touchdown point Secondary base	LF	2
NAVIGATION		
Navigation waypoints	B	1-9
Target waypoint	M	1-9
Popup point	U (RED)	1-9
Visual fix in progress	E	1-9
Radar fix in progress	E (flashing)	1-9
RECONAISSANCE		
Corner and centre points	R	1-9
Measured targets	M (RED)	1-9
Tracked targets	S (RED)	1-9
Mark points	BX	1-5

BX6-9 are used for RB 15 missile planning and cannot be used by the aircraft for navigation.

Course indication

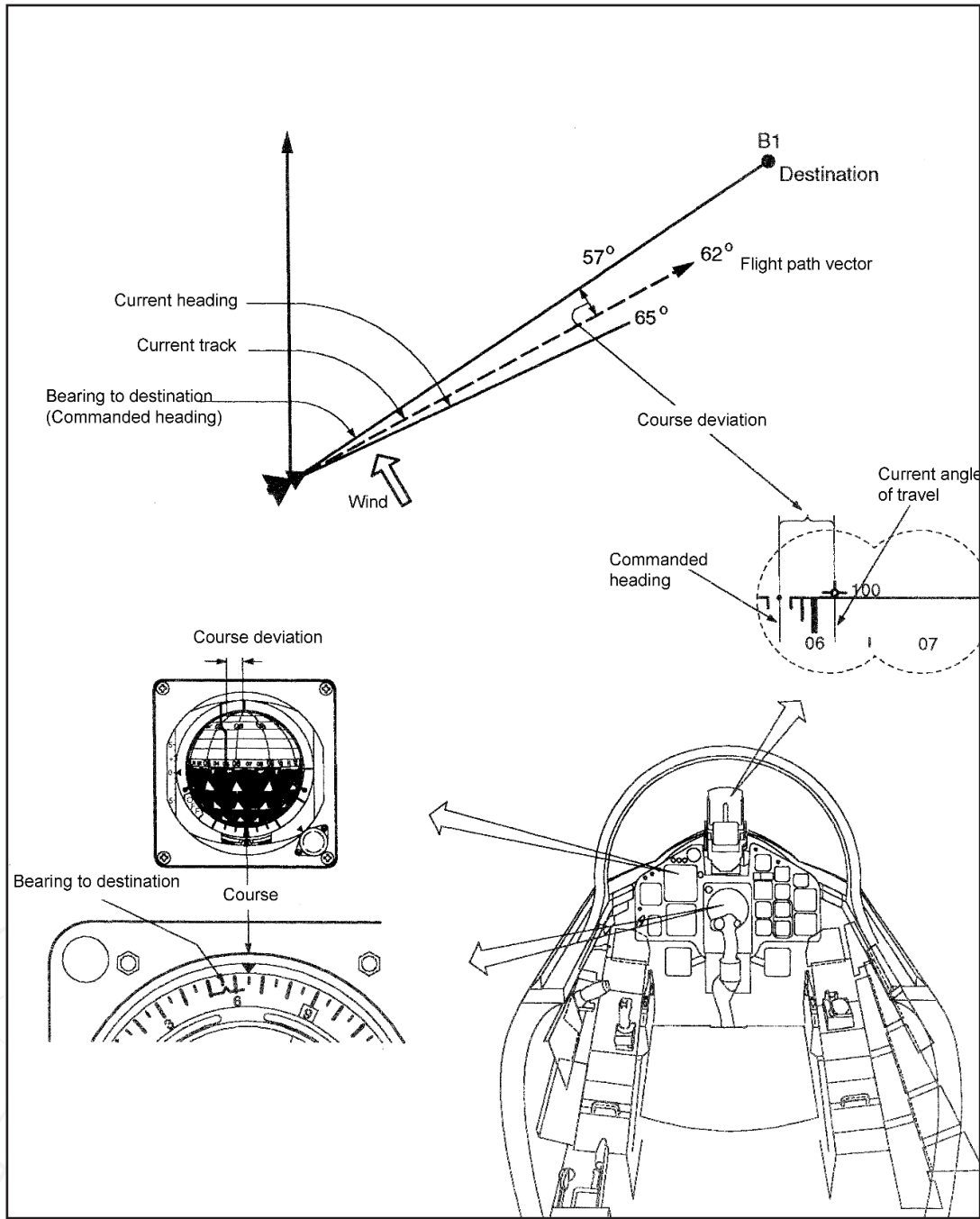

Figure 103. Course indication

TILS

TILS (Tactical Instrument Landing System) is the instrument landing system for the Swedish Air Force, introduced with the 37 Viggen system. The system is designed to allow instrument landings in poor weather. Unlike a normal ILS system with a large array for glideslope and localiser constructed near the runway threshold, the TILS system is a single, smaller unit placed next to the runway. The system consists of a transmitter unit on the airfield and a receiver unit mounted on the aircraft. The receiver interprets the signal from the transmitter and creates a steering command. The slight offset from the runway heading, combined with a landing waypoint (LB) set by the navigation system results in a slightly curved approach.

Transmitter

The TILS unit is usually placed 50 metres to side of the runway at the touchdown point. The transmitter sends out two rapidly sweeping signal lobes, one localiser for the horizontal reference and a glideslope for the vertical reference.

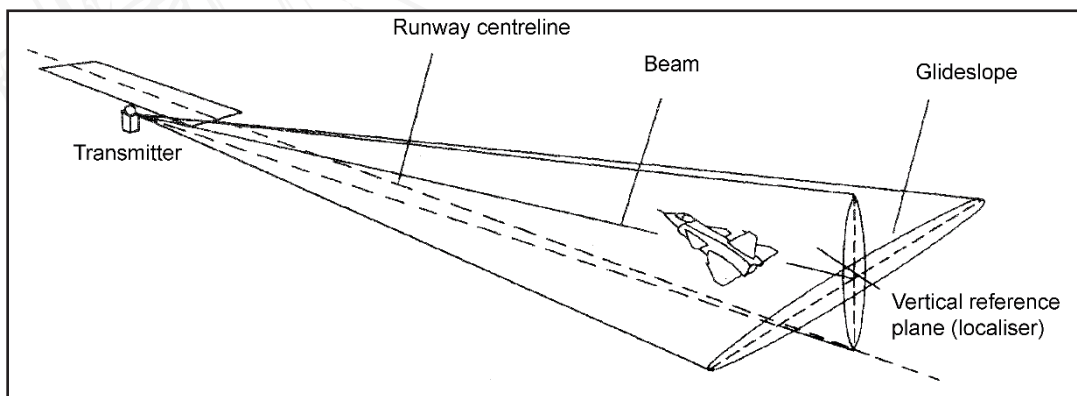

Figure 104. TILS principle.

Localiser beam width: $\pm 35^\circ$, wherein a $\pm 15^\circ$ area where the signal is linear (proportional), beyond which the signal merely indicates the direction of the localiser beam.

Glideslope beam width: $0-10^\circ$. The glide slope is 2.86° (1:20 ratio).

Range: 100km in fair weather, signal strength may deteriorate in adverse weather conditions.

The localiser, due to the placement of the transmitter unit will diverge from the runway heading, yielding a 3° offset approach from the runway centreline. This leads to the localiser beam intersecting the runway centreline at about 900 metres away from the runway threshold. As a result, the TILS system cannot be used for the last portion of the approach, however the runway should be in sight at that distance and altitude for a visual landing.

Channel selection

The system contains a maximum of 20 possible channels. The computer will attempt to use the channel pre-stored in the memory if the airfield was entered using a reference number ,or entered in BANA/GRÄNS if the TILS selector is set to A (Automatic).

The TILS channel may be selected manually using the TILS channel selector dial on the navigation menu in the event of a CK failure. The dial is marked with 10 channels. The TILS channel group selector switch changes the selection from channels 1-10 to 11-20.

Please refer to the in-game kneeboard or Airfield reference sheet for TILS channels.

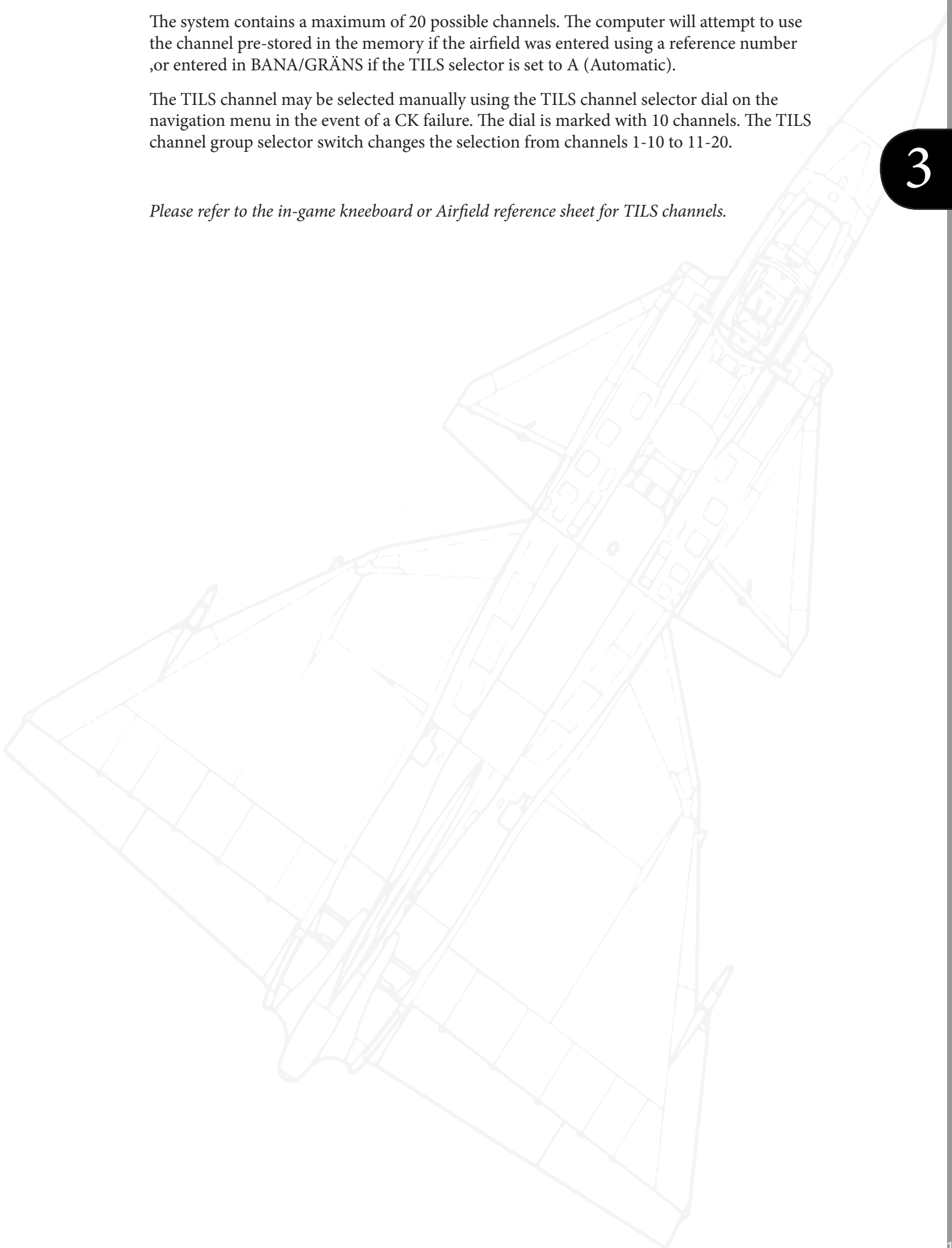

Operation

Please refer to the Instrument approach and landing section of the procedures section.

TILS is automatically selected when the Master Mode selector is set to mode LANDNING NAV.

3

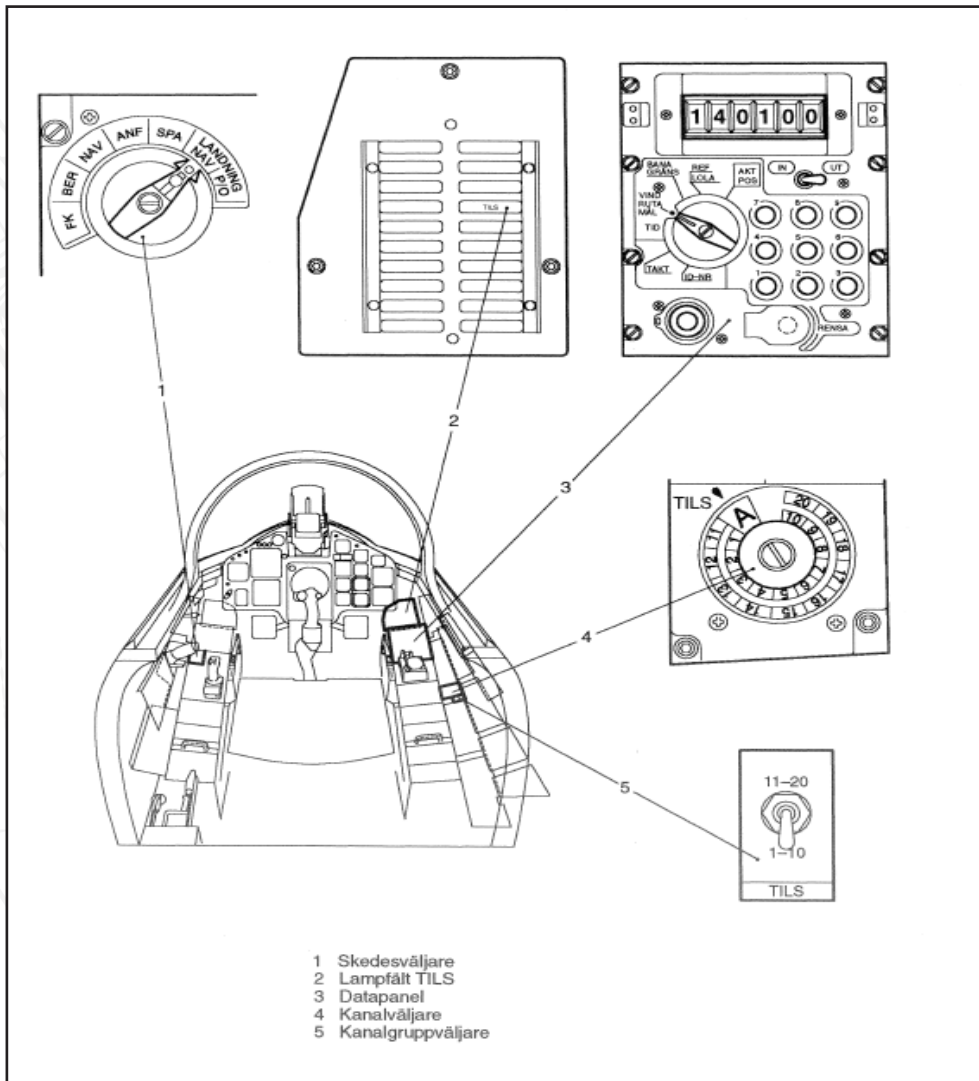

Figure 105. TILS controls.

1. Master Mode selector
2. TILS indicator light
3. Data panel
4. TILS channel selector
5. Channel group selector

Indication

The TILS commands are displayed in the HUD with the pole track, as well as on the ADI with the flight director needles.

The TILS information is presented during landing phases 2 and 3. The indicator light TILS on the right indicator table will flash when the localiser is locked, and will be lit with a steady light when both localiser and glideslope are used.

Landing phase 2

During phase 2, the TILS-calculated distance is shown on the distance indicator.

TILS calculated steering commands are shown on the commanded course on the HUD, as well as the flight director needles on the ADI.

In case of CK or primary flight data unit failure, only the deviation from the TILS guide beam is indicated. The time / distance line will indicate time to glide path intercept beginning when 40 seconds remain until intercept.

Landing phase 3

During phase 3, automatic TILS fixes are continually made to update the aircraft's position in the navigation system. Glide path line, reticule, and pole track on the HUD as well as flight director needles on the ADI indicate flight along the guide beam (glide path and localiser). On the distance indicator, TILS-calculated distance is shown. Timeline is not displayed during phase 3.

Steering information from TILS

Normally, steering information from the navigation system along an entry arc towards the runway centreline is first used.

When the aircraft during this approach receives TILS signals (localiser and glideslope) and the computer accepts these signals, the computer can use steering information to fly towards the guide beam. If the landing waypoint LB is used, the TILS information is used after LB is passed. If a short approach is used, TILS information is used to generate steering commands as soon as the signals are accepted by the computer.

The entry onto the guide beam is conducted in the following manner.

- If the TILS side signal (localiser) is linear, a steering command is created towards a point on the guide beam in front of the aircraft, which provide a gentle entry onto the guide beam.
- If the TILS signal is constant a commanded angle of 45° is set relative to the guide beam, until linear TILS signals are received.

Note.

The flight path vector is as normally limited to 8.5° horizontally, so during very heavy crosswinds the flight vector may not represent the true vector. The aircraft will however follow the guide beam if the steering commands are followed.

TILS approaches

3

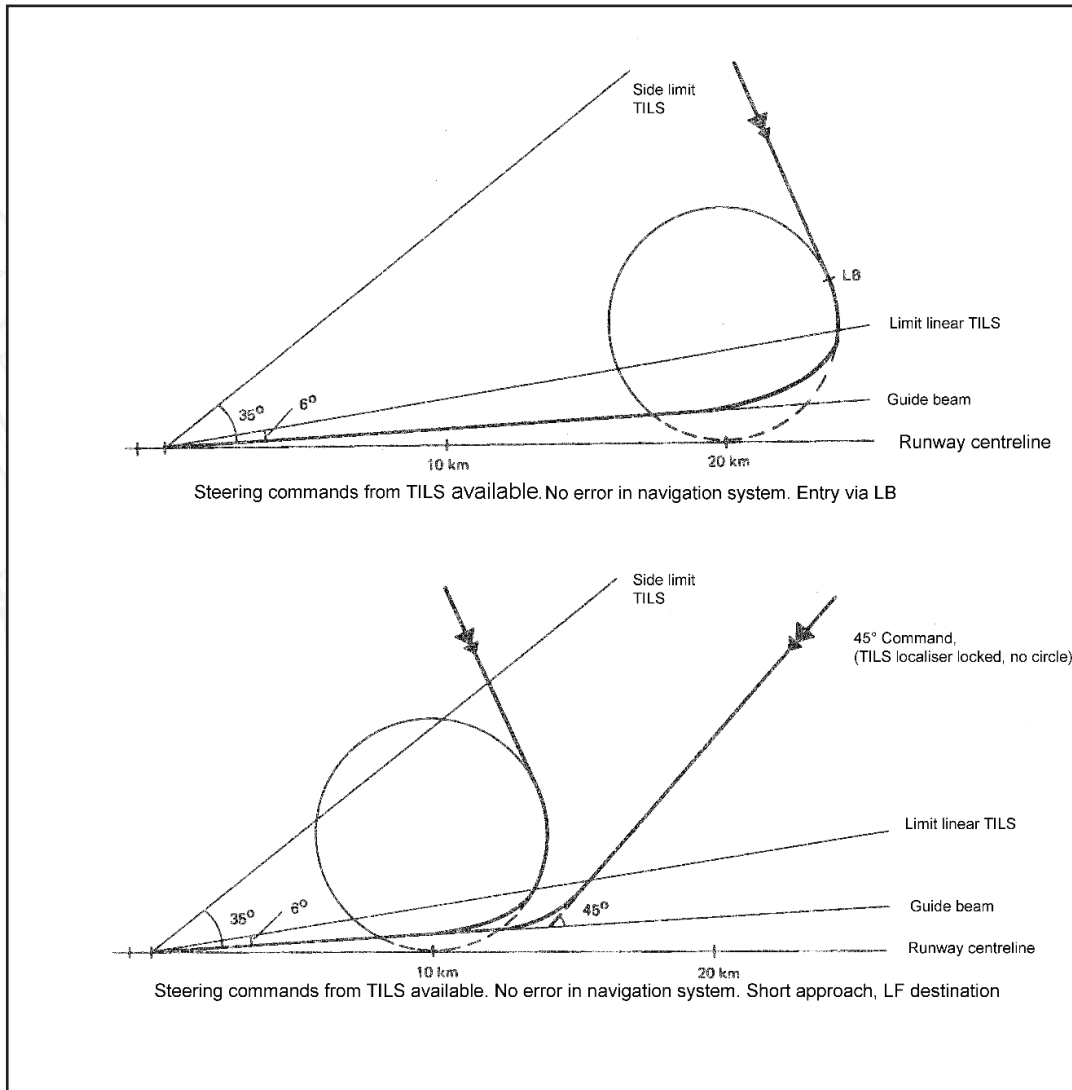

Figure 106. TILS approaches.

TILS approach with a position error in the navigation system

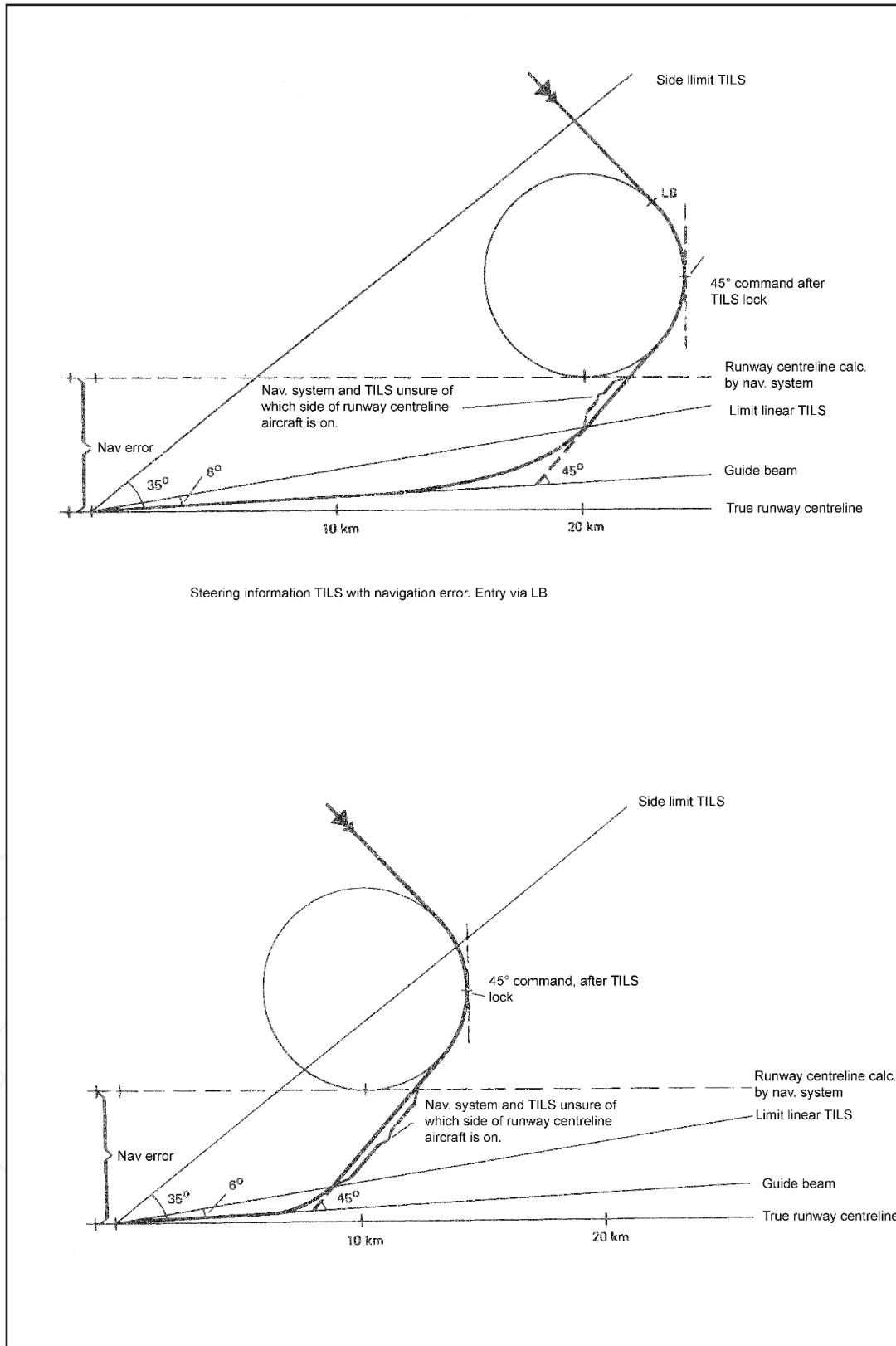

Figure 107 TILS approach with a position error in the navigation system.

Landing & navigation

Landing types

Approach towards the airfield begins when a landing waypoint (L1 or L2) in master mode NAV becomes a destination (active waypoint). The destination becomes the centre of the chosen runway. The actual landing indication on instruments and steering commands is presented first in LANDNING NAV.

The landing can be done either as a direct approach or an overhead pass.

A direct approach is one that flies towards the extended runway centreline without overflying the airbase. Normally, the approach is done via the landing waypoint LB. Alternatively, it can be done via a so called “short approach” and where the aircraft lines up on the runway closer to the touchdown point LF.

During an overhead pass, the pilot overflies the runway in mode NAV before switching to mode LANDNNG NAV and flies towards the extended runway centreline. An overhead pass can also be approached via the landing waypoint LB or by a short approach.

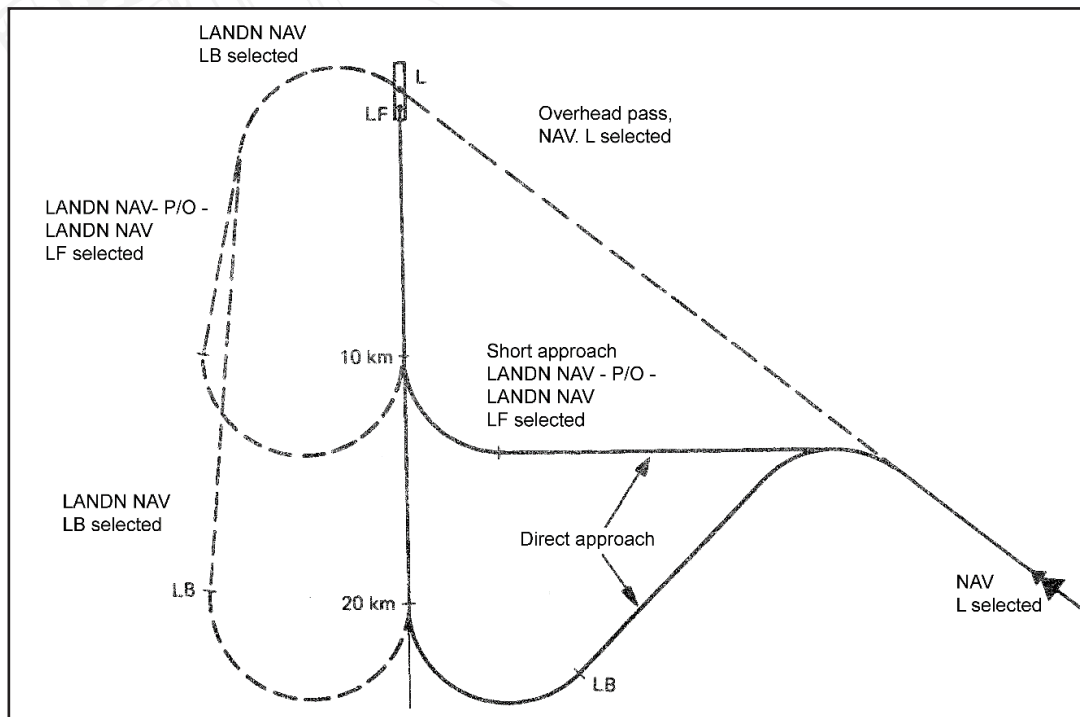

Figure 107. Approach and landing types.

Landing in mode LANDNING NAV can be divided into three phases.

- Phase 1 begins when the master mode selector is set to mode LANDNING NAV where LB becomes the destination (active waypoint).
- Phase 2 begins when LF becomes the destination, i.e. LB is passed or a short approach is chosen.
- Phase 3 begins on descent command is received (assumes TILS use), normally 10 km from the touchdown point LF.

Steering commands

For the steering commands to make sense and actually be useful during the approach, either a low position error or TILS availability is required.

During phase 1, the steering commands are based on the navigation system and the estimated aircraft position.

Phase 3 only occurs if TILS is used / available. During phase 3, the steering commands are based on the glideslope and localiser of the TILS-information. If this information is lost or not accepted, phase 3 is aborted.

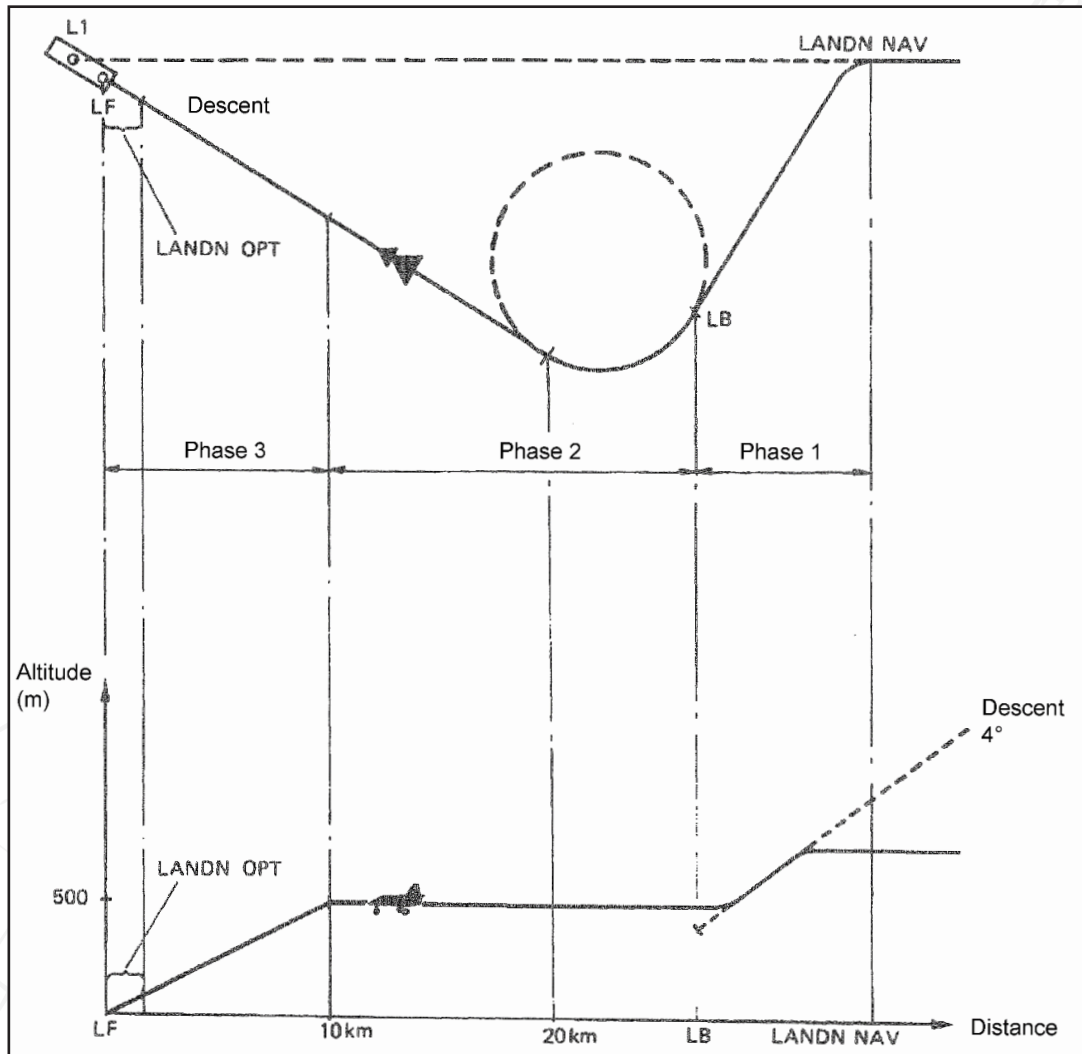

Figure 108. Steering commands and approach profile.

Approach mode NAV

On destination change to the landing waypoint, the central indicator displays an extended runway centreline of the chosen runway. The line corresponds to 20 km and aligns along the extended runway centreline.

3

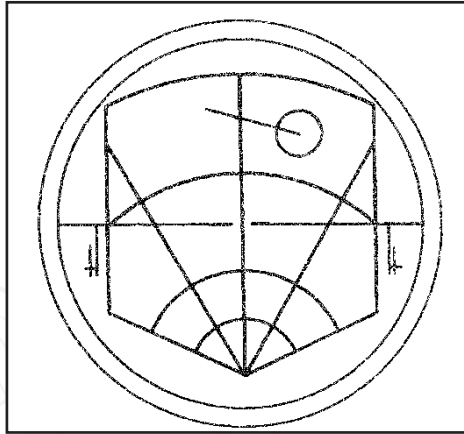

Figure 109. CI symbology in NAV with a landing base waypoint selected.

Landing phase 1

Phase 1 lasts from the moment the master mode selector is set to mode LANDNING NAV to the point where LB is no longer the destination.

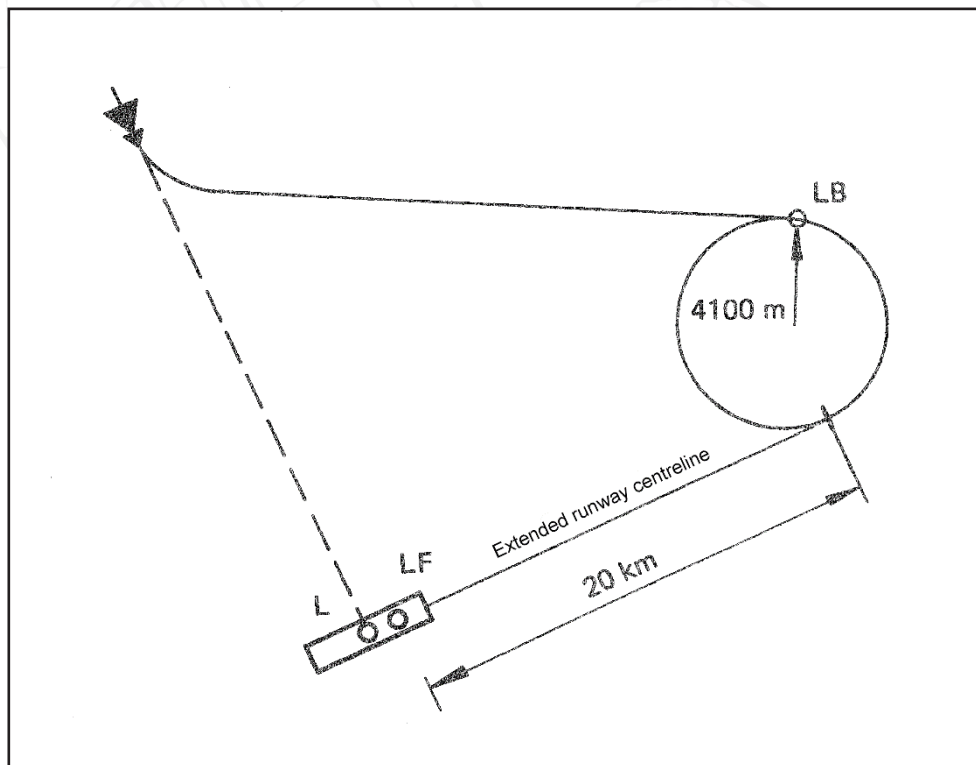

Figure 110. Landing phase 1.

The landing waypoint is the point where a straight line from the aircraft tangents the approach circle. The coordinates for LB are continuously calculated by the computer, while the aircraft is turning towards LB. Thereby, the aircraft will intercept the circle on a tangent.

The approach circle is placed on the side of the extended runway centreline the aircraft is on. The circle tangents the extended runway centreline 20 km from the touchdown point and has a radius of 4100 m. The radius of the circle corresponds to 550 km/h with a bank angle of 30°.

Indication during phase 1

When the master mode selector is set to mode LANDNING NAV the destination indicator switches from L1 (or alternatively L2) to LB1 (alternatively LB2).

On the Central Indicator, the approach circle and extended runway centreline are shown, indicating whether a left or right turn onto the runway centreline will be made. Thereby, the “ring” no longer corresponds to the runway centre point as it did previously.

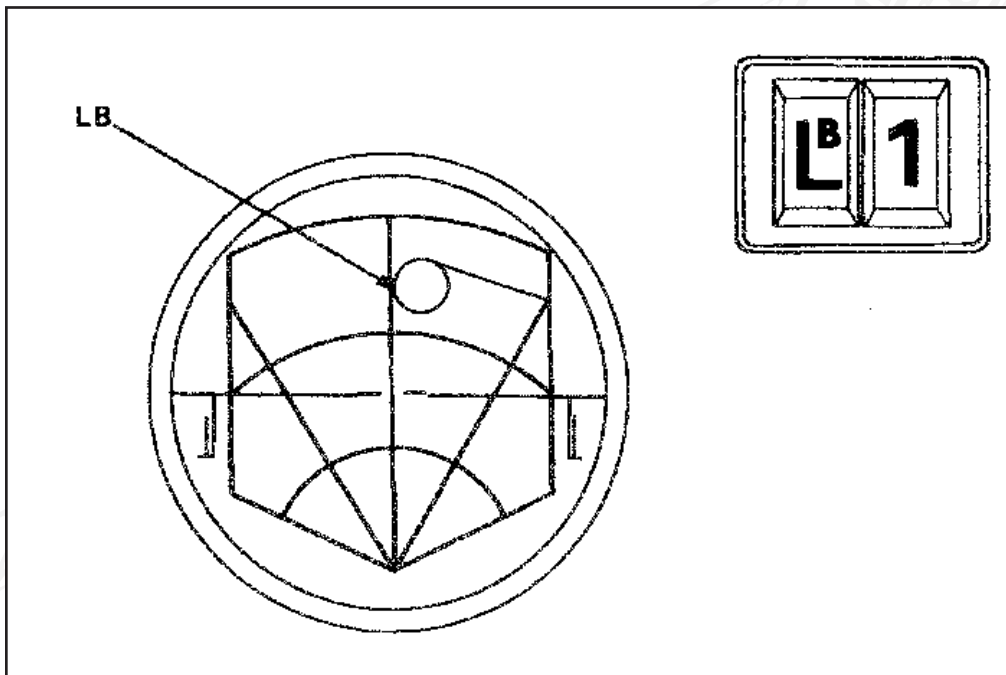

Figure 111. Indication during phase 1.

The commanded heading bug on the course ring indicates the heading, and the distance indicator indicates the distance towards LB. Steering commands are displayed both on the HUD and the ADI.

If the flight altitude is less than 600 m, a steering command is set towards 500 m altitude.

If the flight altitude is more than 600 m the steering command is set to the current altitude when the selected LANDNING NAV is selected. When the aircraft approaches, a descent command is given in the HUD and ADI so the aircraft follows a 4° descent towards 600 m altitude.

The normal navigation display resumes with a commanded altitude of 500 m. The time line appears 40 seconds before the descent command is given. The descent command is given when the time line reaches the markers. If the descent command is followed, the aircraft should reach 500 m altitude just before the approach circle is reached.

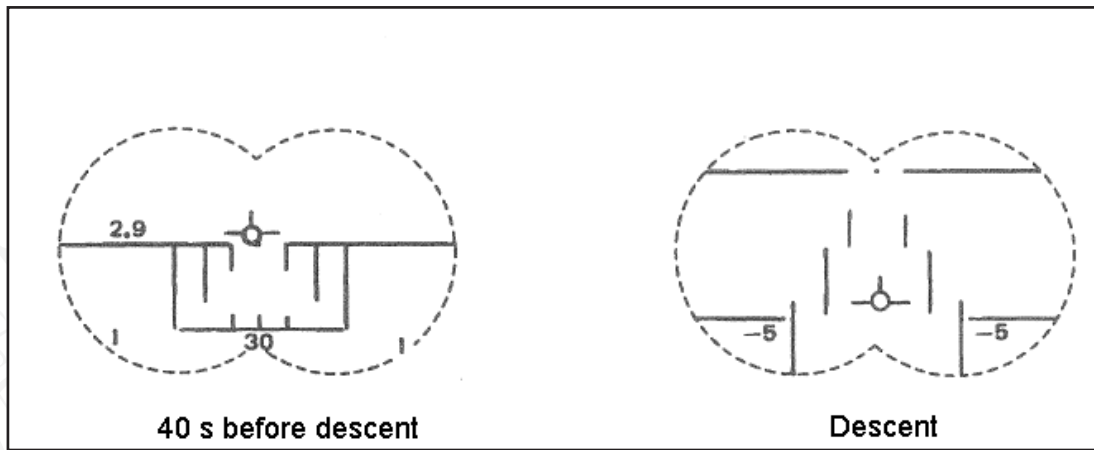

Figure 112. HUD symbology with descent command.

During the entire approach, the airspeed deviation indicator fin displays a deviation from the reference speed of 550 km/h, or the airspeed corresponding to the set angle of attack mode of the AFK.

Landing phase 2

Phase 2 begins when the touchdown point LF becomes the destination, which occurs automatically when the aircraft passes LB, or if chosen manually (short approach). If TILS information is available, it is used to generate steering commands onto the guide beam.

During a normal approach, phase 2 is initiated by the aircraft flying along the circumference of the approach circle until aircraft's angle of travel is less than 90° toward the guide beam's direction. After this point, the aircraft is steered towards the guide beam by steering commands generated by the TILS signal. The guide beam is then followed and phase 2 is finished.

Indication during phase 2

The destination indicator switches from LB1 (or LB2) to LF1 (or LF2).

Display on ADI, HUD, CI, course ring, and distance indicator is dependent of whether TILS is used or not.

If TILS localiser is used the TILS indicator light on the right indicator panel blinks. If both glide path and localiser is used TILS is lit solid.

Phase 2, TILS not in use.

All the navigation indication are based on the navigation systems estimation of the aircraft position. The course indicator bug on the course ring indicates the heading towards the touchdown point LF. On the CI, the circle marker indicates the touchdown point.

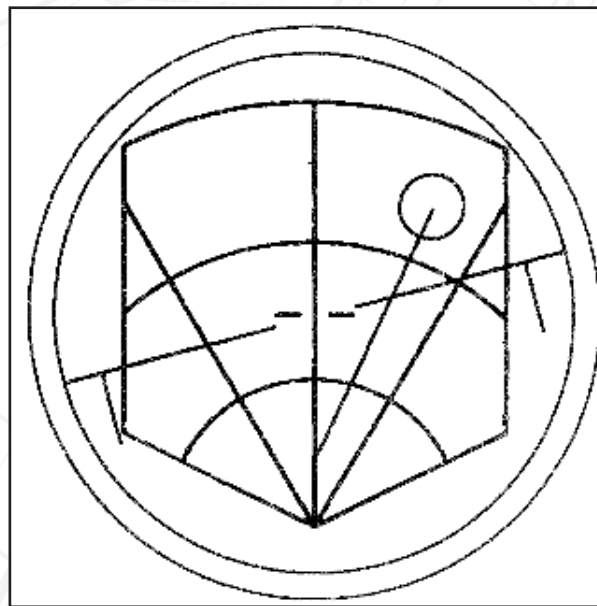

Figure 113. CI indication during phase 2. Ring indicating touch-down point.

Steering command along the circumference of the approach circle is displayed on the ADI and the HUD in the following manner.

If the aircraft angle of travel after passing LB diverges more than 5° from the extended runway centreline, the pole track and reticule in the HUD moves to correspond to a bank angle yielding a 4100 m turn radius. The turn command will result in different bank angles depending on the current airspeed. These commands are limited so that a bank angle greater than 45° is not achieved.

3

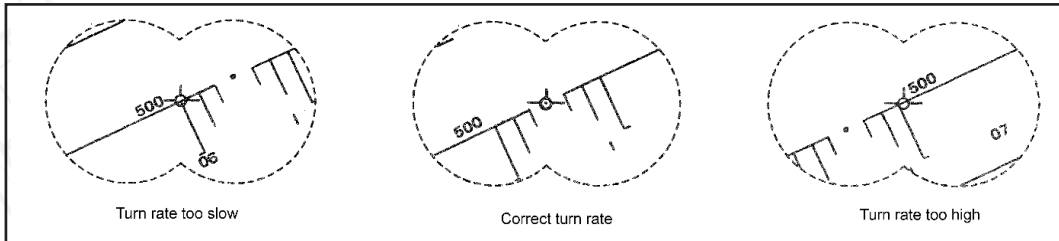

Figure 114. HUD with TILS turn indication.

When 5° remains of the turn, a gentle slow in the turn rate is given. When 0.5° remains the commanded course angle is set to the runway centreline, where a small “jump” in the indication signals that the turn should end. The aircraft will travel down the runway centreline. Any divergence from the runway centreline will be corrected by a steering command to a point 2km in front of the aircraft on the runway centreline.

The indication on the ADI is the same as the HUD with the flight director needles indicating the commanded course and altitude.

When the aircraft, according to the position estimation, is 40 seconds away from the descent point, the time line appears. The line shrinks with such a rate so the descent point is reached when the line reaches the markers.

Phase 2 with TILS in use

The course ring bug and distance indicator display bearing and distance respectively towards the touchdown point LF. This indication is based on TILS information and computer calculated barometric altitude (standard or ground pressure, QFE). An incorrectly (or missing) height pressure (QFE) setting will result in a slightly erroneous distance indication when TILS glideslope is used. The circle marker in the Central Indicator displays the touchdown point.

Steering commands on the HUD and the ADI toward the guide beam are displayed in the following manner:

When only a constant localiser signal is received, a 45° angle command is given. If the aircraft angle of travel deviates from the angle command more than 5° , a steering command is given similar to if TILS was not in use. The difference is that instead of a constant turn radius, a constant rate of course angle change of $2.2^\circ/s$ is used instead. At 550 km/h, the turn radius will still be 4100 m, but if the airspeed is lower or higher, the radius will be smaller or larger.

When a linear localiser signal is received, a steering command is set towards a point on the guide beam. The steering commands are designed to provide a gentle intercept onto the guide beam.

The indication on the ADI is the same as the HUD with the flight director needles indicating the commanded course and altitude.

When the aircraft is 40 seconds away from intercepting the glide path, the time line appears in the HUD. The descent command is given when the time line reaches the markers. When the aircraft intercepts the glide path, the indication automatically switches to phase 3 if the computer is using both linear glide path and localiser.

Landing Phase 3

Landing phase 3 is automatic and only occurs on the condition that linear localiser and glide path signals are received and used by the computer to calculate the aircraft position relative to the runway. Switch to phase 3 occurs when the aircraft intercepts the glide path, which happens at 10 km from the touchdown point if the approach is at 500 m altitude.

If the computer does not accept any of the TILS signals, or if the aircraft flies outside of the linear areas for more than 5 seconds, phase 3 is aborted and phase 2 resumes.

When the altitude is less than 30 m, phase 3 ends. The visual landing mode is engaged automatically. If the glide path is followed, phase 3 will end 600 m from the touchdown point. As the glide beam crosses the extended runway centreline about 900 metres (about 45 meters altitude) normally the TILS beam is not used when the switch to the visual mode occurs.

Phase 3 indication

The HUD symbology is a glide path (2.86°) with a pole track beneath the artificial horizon. The pole track indicates the aircraft's position relative to the glide path. The aircraft is on and following glide path if the pole track aligns with the glide path line, and the flight path vector is on the glide path line.

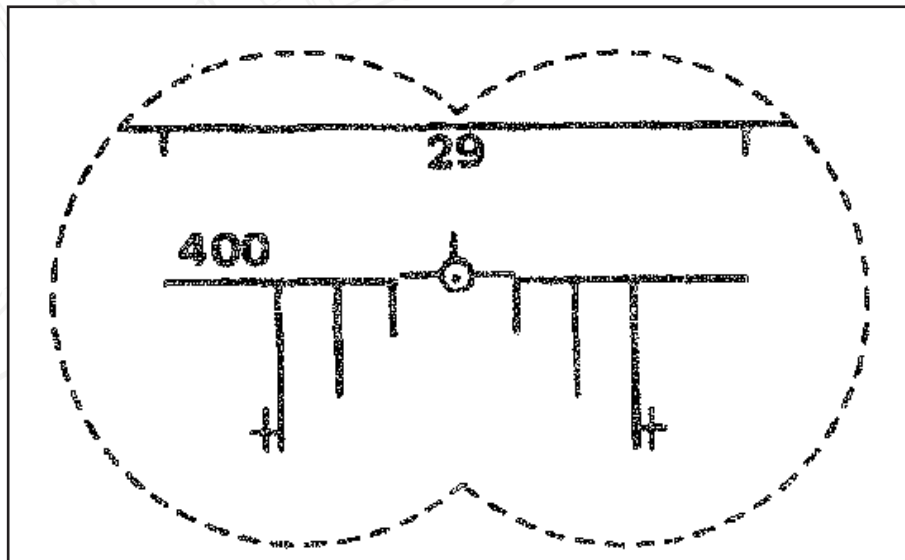

Figure 116 HUD symbology during descent. Glide slope and deviation from TILS glideslope shown with the pole-track.

The ADI needles indicate the steering commands for the localiser and glide path.

During phase 3, continuous TILS-fixes are made and any position errors in the navigation system are corrected. This may lead to the CI symbols moving slightly.

Visual landing mode

During visual landing mode, also known as P/O (PAR or Optical), no TILS information is used. All navigation indication is based on the aircraft's position estimation. Visual landing mode is automatically switched to during the last part of landing phase 3 or switched manually by setting the master mode selector switch to mode LANDNING P/O.

The HUD symbology is a reticule and a glide path line reference line placed 2.86° below the artificial horizon.

The reticule and glide path line will point in the direction of the runway heading in order to aid the pilot in aligning with the runway.

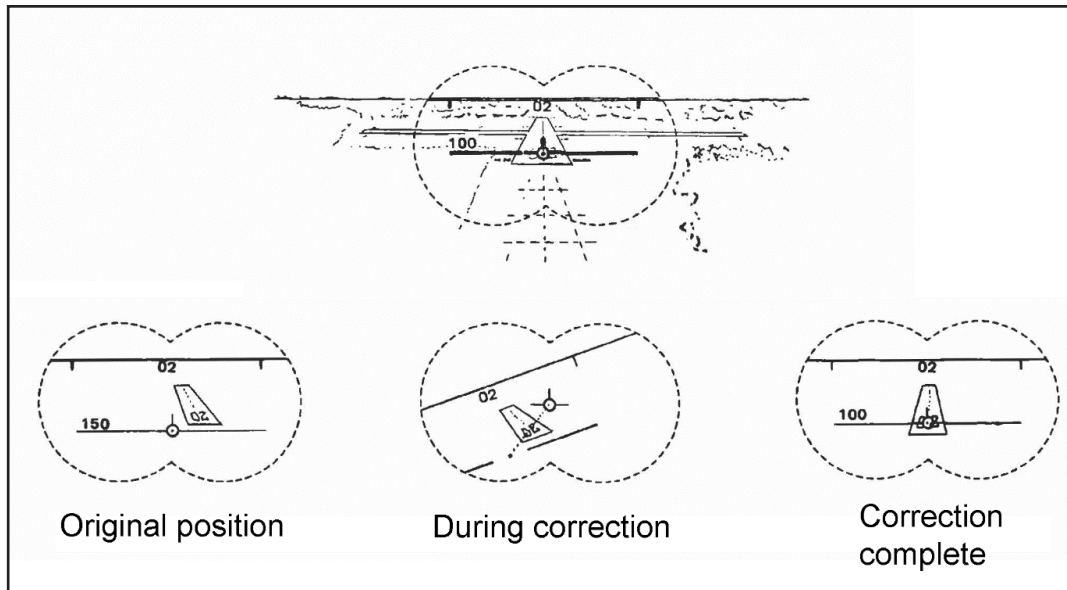

Figure 115. Visual landing and correcting onto runway heading.

The glide path line and reticule can be locked in centre sideways if the SLAV-SI switch is set to ON (TILL). The flight director needles on the ADI are then stowed.

Descent rate mode

At very low altitudes the glide path line switches function to no longer displaying a glide path but instead indicates the descent angle corresponding to 2.96 m/s descent rate, which should not be exceeded during landing.

The altitude that this mode engages is dependent on whether radar altimeter is used. If radar altitude is used, the mode engages when the altitude is less than 15 m . If barometric altitude is used, the altitude is 30 m .

Alternative landing modes

3

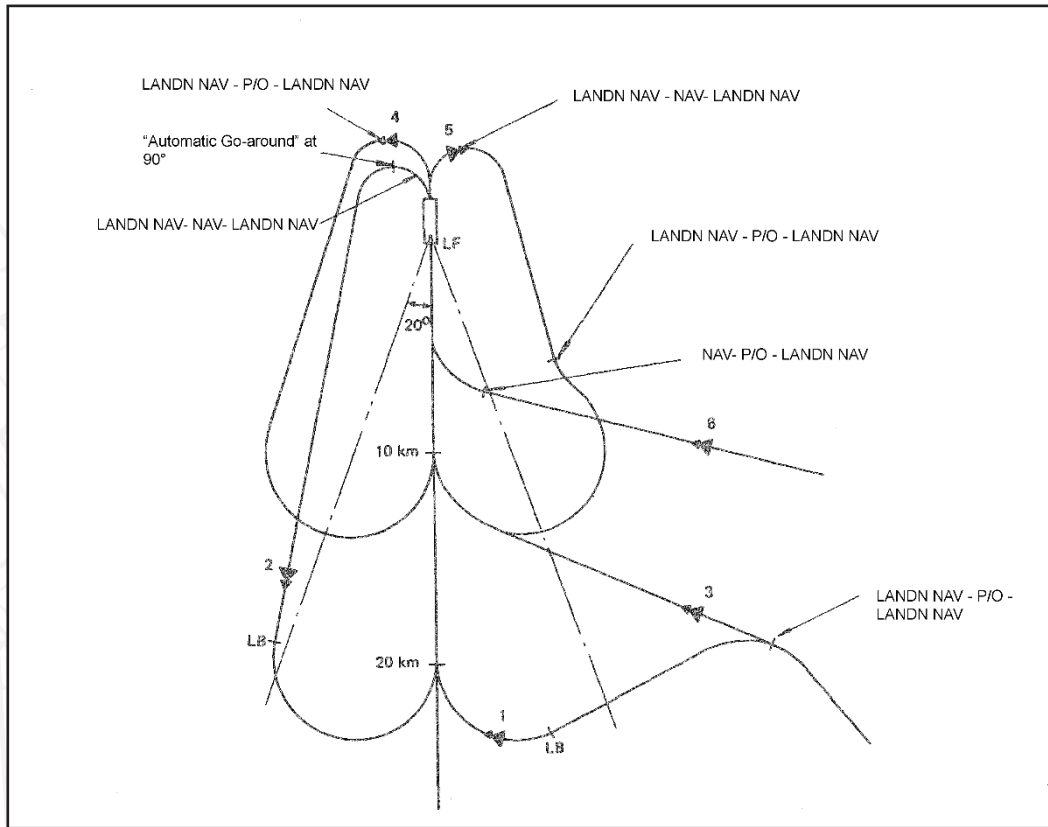

Figure 116. Alternative landing approaches.

1. Normal approach
2. Normal Go-around
3. Short approach
4. Go-around with short approach
5. Normal Go-around shortened by "flip-flop"
6. Free approach

Alternate runway heading

The pilot can choose another runway direction by setting the data panel selector to mode BANA, and the IN /OUT switch to OUT, and press the L MÅL button. Pressing the button will cycle the runway directions.

Selection of runway heading can be done whenever in mode NAV or LANDNING as long as the landing base is the destination. During runway heading switch, landing phase 1 is selected, regardless of current phase.

On pressing the waypoint button L MÅL, the chosen runway heading will cycle. This is indicated by a flashing "L" on the destination indicator if an alternate heading is chosen. If the selection is done in mode LANDNING, the LB point is switched instead.

If the landing base has been entered via a reference number, the system will cycle through the available runways on that base, beginning with the next highest number.

If the landing base has been entered manually (by longitude and latitude coordinates) in BANA, only a reciprocal (180°) heading from the entered runway can be chosen via runway heading switching. However, an alternate runway heading can be chosen by inputting that information manually.

If a TILS transmitter is positioned on the new runway heading, it can later be used only if the runway heading and TILS channel are entered manually.

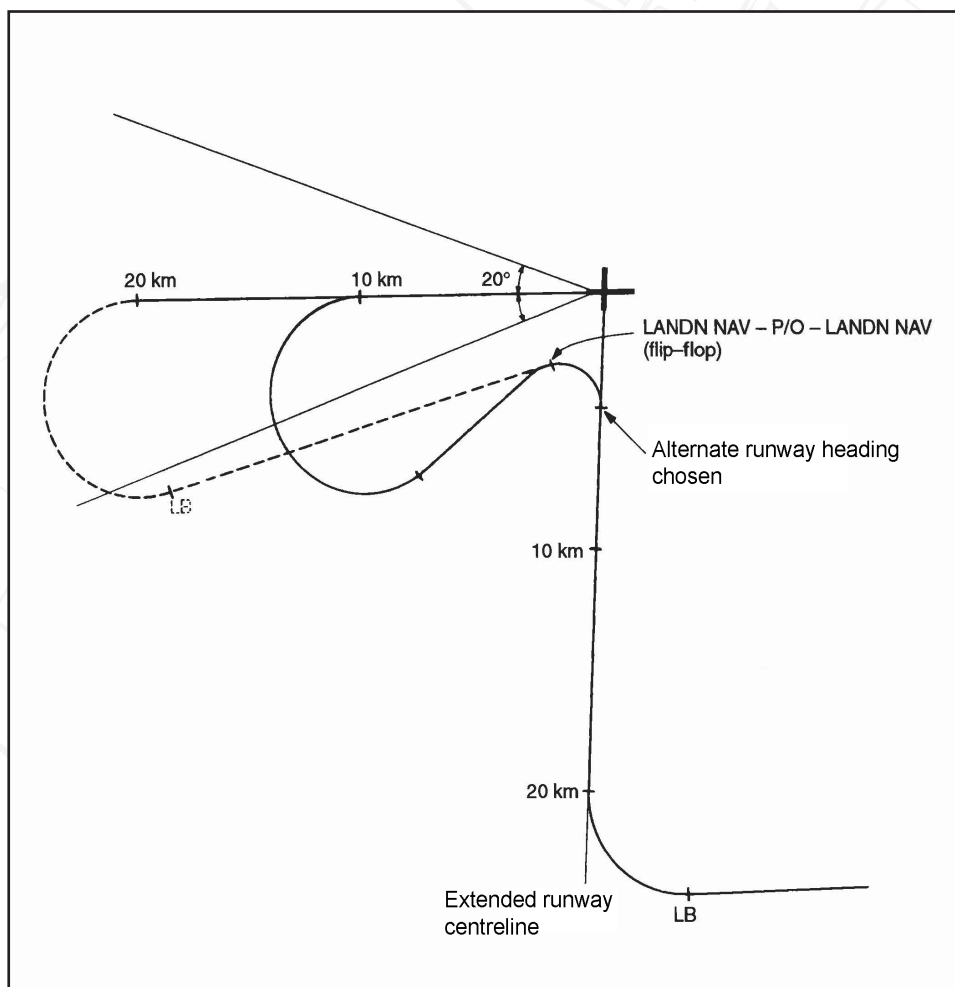

Figure 117. Alternate runway heading selection.

Short approach (flip-flop)

The pilot can choose a short approach by selecting the touchdown point as a destination manually before the landing waypoint LB is selected. The touchdown point is selected by moving the master mode selector from mode LANDN NAV to LANDN P/O and back to LANDN NAV (a so called flip-flop), thereby resulting in a steering command onto the extended runway centreline.

During a short approach, if the navigation is based on TILS information, the steering commands and indication will be exactly the same as phase 2 during a normal approach.

If TILS is not available, the navigation calculations and indication will depend if the aircraft is in a sector of $\pm 20^\circ$ relative to the extended runway centreline. If the aircraft is in the sector and the angle of travel is less than 90° from the runway heading, a steering command is given for centreline intercept. The steering command is set to a point 2km in front of the aircraft on the extended runway centreline. If the aircraft is outside of the $\pm 20^\circ$ sector or if the angle of travel is more than 90° relative to the runway heading, a steering command is set towards an approach circle similar to that of the normal phase 1. The approach circle is set 10 km from the touchdown point and is displayed as an angle command on the ADI and HUD. The bearing and distance on the course ring and the distance indicator displays is toward the destination LF.

Switch to phase 3 is the same as the normal approaches if TILS is available and the glide path is intercepted.

Note: As opposed to a normal approach via LB, the computer can start using TILS before approach circle has been passed.

Go-around

If the aircraft during phase 2 or 3 turns away from the centreline so that the angle of travel is greater than 90° , steering commands are returned for a new approach via the landing waypoint LB.

This automatic go-around feature is not used in the visual approach mode.

The pilot can also select a new approach by setting the master mode selector from the current landing mode (LANDN NAV or LANDN P/O) to mode NAV and back to LANDN NAV for a new approach via LB.

Go-arounds can be used as a short approach as well.

Free approach

The pilot can choose to do a “free” approach in mode NAV, by for example using the display on the CI and then choose to use a TILS short approach (LANDN NAV and the same procedure as short approach) or use the visual landing mode (LANDN P/O).

Backup approach

In case of CK or flight data error, the approach must be done by the pilot's own navigation calculation or other navigation aids as no steering commands are given by the CK (e.g. HUD display is not available). If TILS is unavailable, the flight director needles are stowed.

If TILS is available, the channel is set via the channel selector. The ADI flight director needles will display the aircraft position relative the guide beam, instead of being steering commands.

TILS information will be used as soon as the linear localiser and glideslope are acquired. This is indicated by the TILS indicator light on the right indicator table.

TILS is not used in mode LANDN P/O.

Position errors and fixing

Due to the minor errors that are inherent to the measurements in all the contributing sources, a certain position error will exist and multiply during the flight. Thereby, the aircraft's assumed position will differ from the "real" position. Therefore it is necessary to occasionally update this position to eliminate this aggregated error. This error can be addressed by making a number of types of fixes.

Flight planning notes:

Easily recognisable terrain features, such as distinctive coastlines and islands or isolated elevations aid in finding the "correct" position of waypoints. Therefore it is useful during the planning stage of the flight to place waypoints on easily recognisable terrain features. The more distinct the individual point, such as the cape of an island or a hilltop, the easier it is for the pilot to make and maintain navigational fixes.

Please refer to the navigation subsection in the procedures section in regards to how to use the specific fix types.

Manual fixes

The manual fixes come in two categories, either an own-position (navigation) fix or a target fix. An own-position fix is made on normal waypoints (B1 - B9) and target fixes on target waypoints (M1 -M9).

Own-position fixes

Visual

The pilot creates a fix when flying directly above the “real position”. The fix mode is prepared by depressing the first stage of the fix trigger of the radar control stick (T1). When directly above the position, the pilot depresses the second stage of the fix trigger (T1-TV-T1).

Navigation points (B1-B9) points and target waypoints (M1-M9) are handled slightly differently. In general one can state that a normal navigation fix is to update the status of the navigation system, whereas the target fix is to update the position of the target “in the real world”

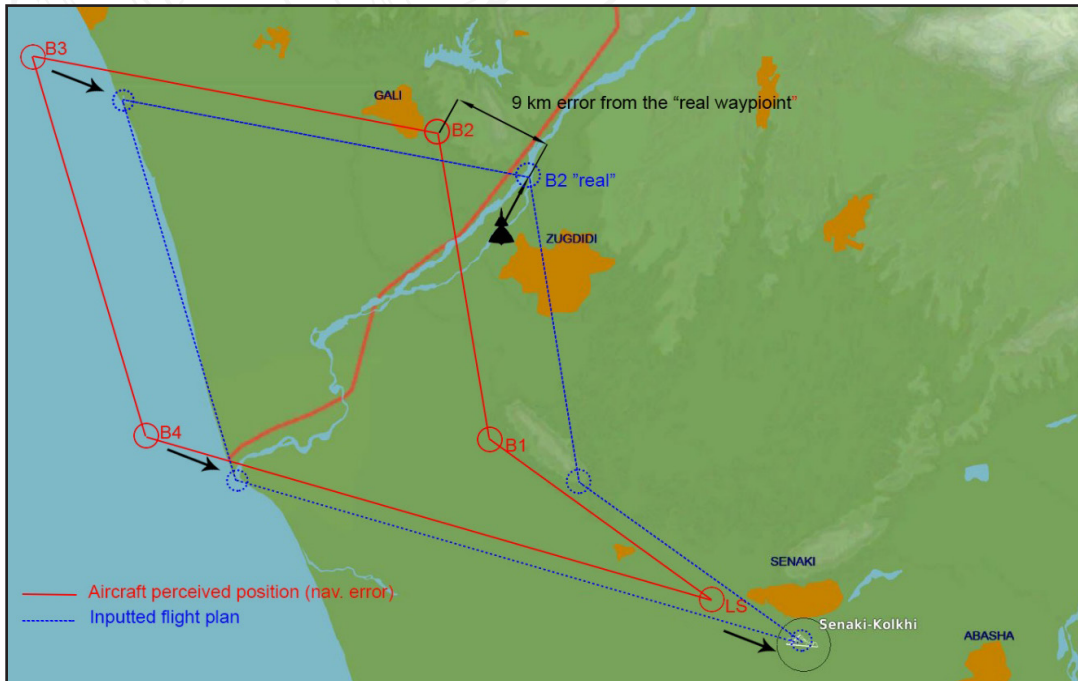

Figure 118. In this case, the navigation system has drifted approximately 9km north-west. The aircraft is currently at waypoint 2 (B2) and the pilot makes a visual fix on the north end of the island in the river where B2 is. The navigation system is then updated and “moves” the entire polygon as the navigational system is corrected for drift by updating the perceived aircraft’s real position in the navigation system. .

In this case, the navigation system has drifted approximately 9km north-west. The aircraft is currently at waypoint 2 (B2) and the pilot makes a visual fix on the north end of the island in the river where B2 is. The navigation system is then updated and “moves” the entire polygon as the navigational system is corrected for drift by updating the perceived aircraft’s real position in the navigation system.

Radar fix

The radar can also be used to create fixes. This enables fixes to be made from a significant distance, even in poor weather, depending on radar picture quality. Radar fixes aid in fine-tuning waypoints at a distance on easily recognisable terrain features. The same principle as the visual own-position fix applies.

Here distinctive terrain that can be observable from a long distance becomes significantly more important.

Target waypoint fixes

If the destination is a target waypoint, only the active target waypoint is moved, thereby correcting the position of the target to fit the “real” target area. This fix does not impact the aircrafts estimation of its position, but merely moves the selected waypoint.

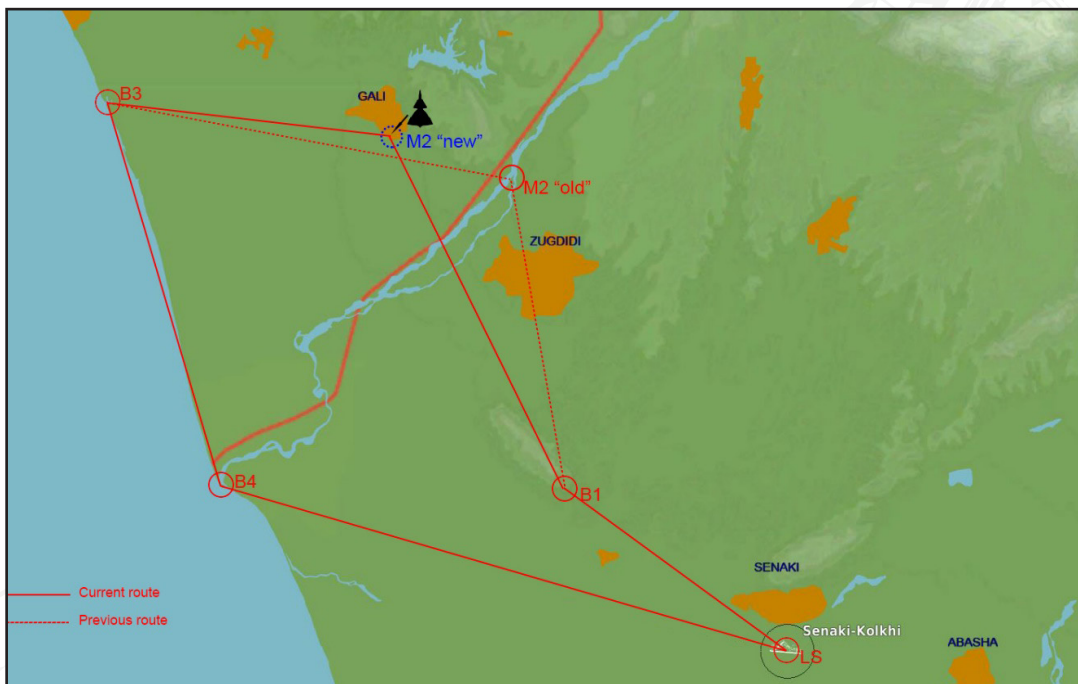

Figure 119. In this case, the target position M2 is moved via a visual target fix (or weapons impact fix) from the island in the river “M2 old” to the outskirts of Gali “M2 new”. Only the current selected target waypoint is moved and the rest of the navigation polygon is unaffected.

Visual

A visual target fix is done in the same manner as the visual own-position fix, with the only exception that the actual waypoint coordinates are moved to the current position as seen by the aircraft.

Radar target fix

Target fixing with radar is one of the main methods of determining the target position in navigation system for weapons guidance and calculation of release points of weapons, such as bombs, anti-ship missiles, and the BK 90 cluster munitions dispenser in particular.

Automatic

TILS- fix

During the final phase (phase 3) of landing, the TILS system will make automatic adjustments based on the TILS system data.

TERNAV

The TERNAV (as described below) will create about 2 fixes per second if the system is ready and operating.

Weapons impact fix.

When firing weapons in modes that have a reticule and a distance line such as the AKAN Gun pods in A/G mode, ARAK rockets and certain bomb release modes, an automatic target fix on the projected impact point.

Automatic initial fix

The origin point is set automatically based on the entered take-off coordinates (either a reference number or longitude/ latitude coordinates).

The fix is made on take-off from or landing on an entered base to establish a starting point for the navigation system. The fix is set on the middle of the entered airbase or the LOLA coordinates.

Note: Due to the fix being set on the middle of the runway, a slight position error will occur during most take-offs.

Fix clearing

While airborne, it is possible to clear the own-position fixes. This is done by pressing the RENSA (CLEAR) button on the data panel (beneath a protective cover) once. This does not clear the target position fixes.

Clearing the navigation system is divided into two steps.

1. The first press of the button will clear the own-position fix, and load the buffered fix.
2. The second press will clear ALL of the own-position fixes.

If an own-position fix has been made after pushing the (CLEAR) button, the next push will be counted as a first push.

The fix clearing feature is used if the wrong position is used for an own-position fix and the pilot is unable to correct the position using the fix system (such as taking a fix of the wrong waypoint). Fix clearing can have greatly detrimental effects on the navigation system as it will deteriorate the basic fix.

Doppler

The aircraft is equipped with a Doppler system that is primarily used to detect changes in direction of travel in the Y and X-axis due to wind. This measurement is added to the navigation data to provide a wind corrected position.

The system is operated by 3 continuous wave Doppler radar lobes sent from the unit situated on the bottom on the right wing.

It measures the aircraft speed relative to the ground in the area 25-500 m/s in the x-axis and ± 100 m/s in the y-axis. The measured ground referenced airspeed is compared to the airspeed for the flight data unit to calculate the wind speed, thereby enabling the navigation system to accurately correct for drift due to wind.

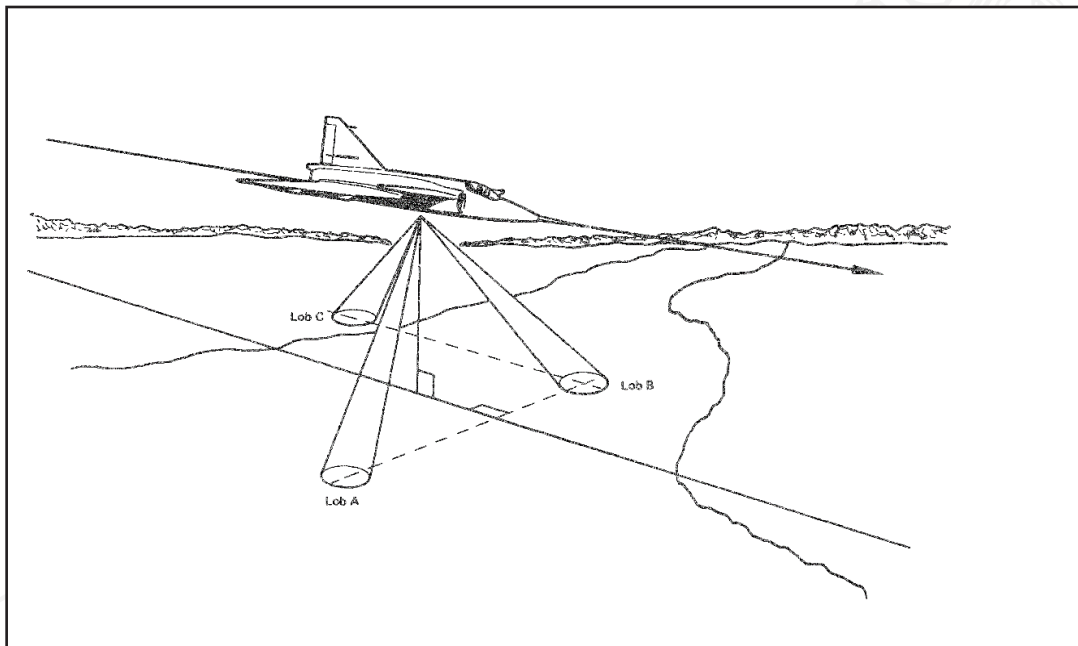

Figure 120. Doppler system operating principle.

The system is largely automatic, but can be toggled via the computer in mode VIND/ RUTA/ MÅL. Please refer to the procedures section for further details

Radar altimeter

The radar altimeter is used to determine the current altitude above ground in the interval 0- 600 m.

The system consists of a transmitter unit in the left apparatus bay and two receivers on the bottom of the fuselage. The radar altimeter is normally always activated.

The radar altimeter can be switched ON / OFF by the RHM switch on the navigation panel, and the altimeter source used by the computer can be toggled with the HÖJD CISI switch on the front panel.



Figure 121. Altitude source selector (right)

Indication

The Warning light RHM FEL indicates a fault in the radar altimeter system.



Figure 122. RHM indicator.

The current radar altitude can be displayed as the radar altimeter index and the digital altitude on the HUD, if the CISI switch on the front panel is set to position RHM.

CK37 calculated altitude

From the static pressure from the flight data unit, the barometric adjusted for sea level altitude is calculated by the computer. This barometric altitude is then adjusted for the altitude above ground level either via the altimeter pressure knob and the pressure setting differs from 1013.2 hPa (Standard atmosphere). This results in a ground calibrated (sometimes called field calibrated) altitude, also known as QFE. The altimeter pressure knob also has the ability to be pressed in to set the Standard pressure of 1013.2 (showing STD in the window) which is mainly used for high-altitude flight where the altitude above ground isn't a factor and a standardised altitude between aircraft is preferred.

CI/HUD altitude source selector (HÖJD CISI)

The ground pressure correction can be made manually either by setting the pressure setting knob, or automatically via the radar altimeter. This is determined by the CISI switch on the front panel. If the selector is in position RHM (Radar altimeter mode) the radar altimeter is used. When the selector is in position LD (Barometric) the pressure calibrated altitude is used.

The pressure altitude can be set by using the radar altimeter, if the reference poles and radar altitude indexes are displayed in the HUD (Radar altimeter on and below 600 m AGL).

Set the CISI switch to mode LD and turn the pressure setting knob until the radar index is at the bottom of the reference poles. This requires flat ground, but can be used to determine current ground elevation calibrated pressure if no other source is available. Otherwise simply comparing radar altitude and barometric altitude when switching between the two modes will indicate the difference between current and barometric altitude.

The calculated altitude is used by the computer for displaying the digital altitude as well as for calculating the difference between current and commanded altitude. Additionally, the calculated altitude is used for the altitude warning systems.

For weapons use, the position of the HÖJD CISI selector will determine the following:

- Digital altitude in the HUD during RB 04, RB 15 and BK90 engagement.
- Calculations for RB 04 and RB 15 release.

The position of the selector does not affect:

- During BK90 release the radar altimeter is always used for calculation of release altitude.
- During the majority of weapons usage, the barometric altitude is used for sight calculations.

Ground collision / altitude warning

The altitude warning functionality of the aircraft is designed to alert the pilot of an imminent impact with the ground or that the set altitude for the autopilot is no longer kept.

There are three main types of warnings.

- Elevation change warning
- Ground collision warning
- Altitude hold warning (2 sub modes)

All altitude warnings are given in the form of an indicator light (red) on the top left of the Central Indicator as well as flashing reference poles and radar altitude indexes on the CI and HUD. Additionally, the indicator light warnings are used for other functions such as during use of the RB 04, RB 15 and BK90.

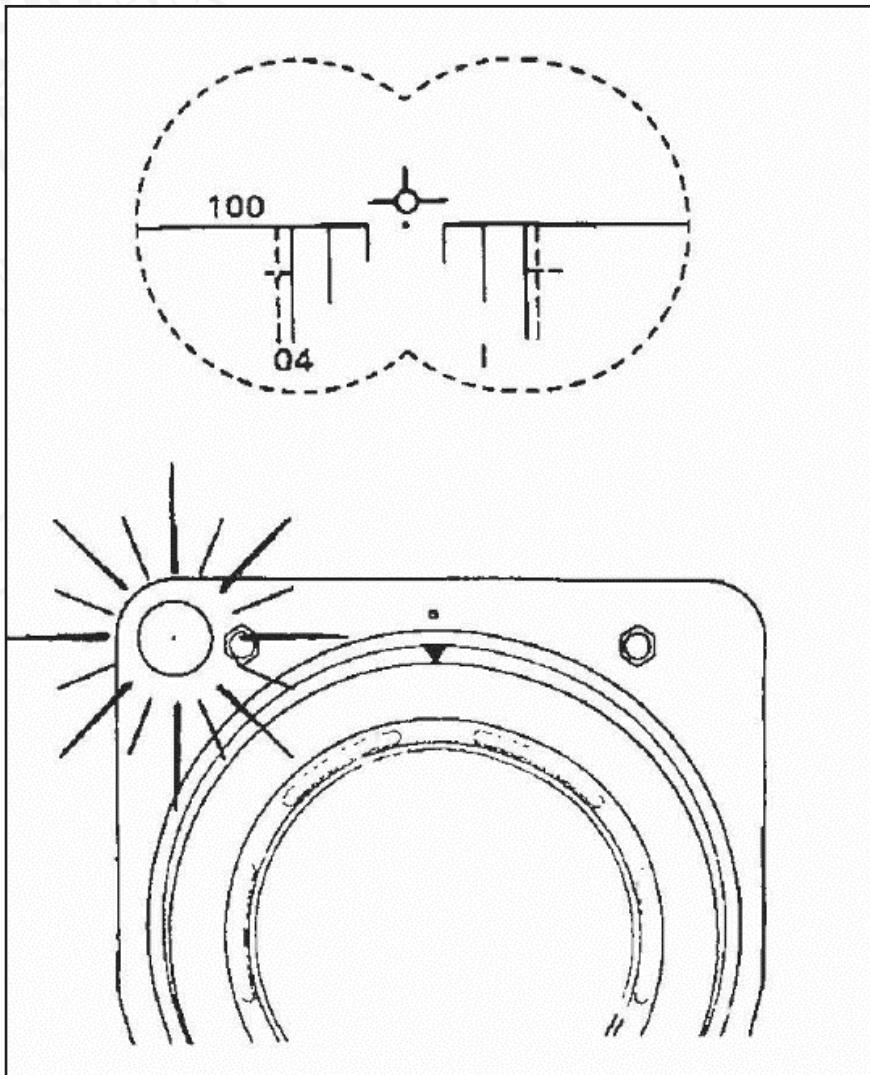

Figure 123. Ground collision / altitude warning.

Elevation change warning

Elevation change warning is received when the altitude source selector HÖJD CISI is in mode LD and the barometric altitude is used. When the radar altitude is less than 150 m and at the same time less than half of the computer calculated altitude the warning is received. This is to alert the pilot of a sudden change in elevation below the aircraft.

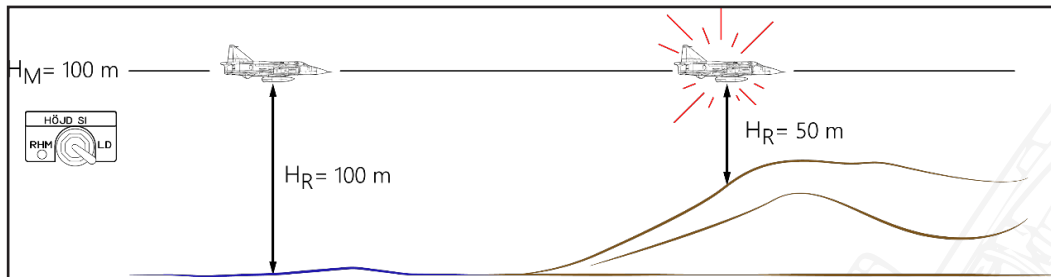

Figure 124. Elevation change warning.

Ground collision warning.

Ground collision warning is received when the radar is used (mode A1 or A2) when the calculated altitude and descent rate is such that the aircraft will impact the ground within 7 seconds. If the radar altimeter is available, the warning is always based on the radar altitude.

This warning is blocked during aiming against ground targets, as well as when the landing gear is extended and the ground calibrated altitude is less than 50 metres.

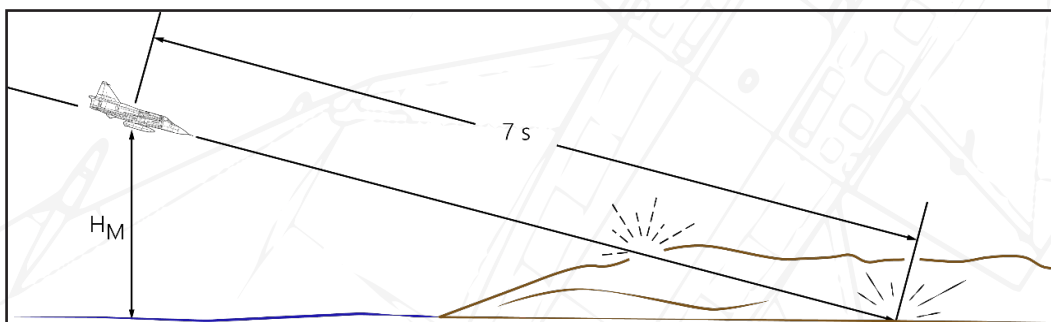

Figure 125. Ground collision warning.

Altitude hold warning

The altitude warning in case of a computer or flight data unit error, the indicator light will be lit with a solid light if the radar altitude is less than 80% of the set altitude. Altitude warnings can also be given during autopilot altitude hold modes.

The warnings consist of a flashing indicator light on the top left of the Central Indicator (5 Hz).

Special uses of the altitude warning light:

Altitude warning – RB 04

After trigger safety is UNSAFE, the indicator light is lit with a solid light if the aircraft is outside the RB 04 release altitude envelope.

Altitude warning – RB 15 / BK 90

After trigger safety is UNSAFE, the indicator light is lit with a solid light if the aircraft is outside the RB 15 or BK 90 release altitude envelope. The same indication has other uses as well.

These uses are addressed in the BK 90 and RB-15F chapters of the procedures section.

Ground collision warning – RB 75

During an attack with the RB 75 (AGM-65 Maverick), the altitude warning is replaced with a ground collision warning. The ground collision warning is based on a warning altitude that a pull-up with 4 G will not be enough to clear 10 metres altitude (with the addition of certain tolerances). The calculation is based on the airspeed vector and speed, as well as calculation for g-build up and reaction time as well as differences for triangulated or radar derived range.

The warning appears when this altitude is less than the barometric altitude or radar ranging derived altitude. After firing only the barometric altitude is used as the radar is turned off after firing.

The warning is indicated by the altitude warning light and the EP13 symbology flashing with 5 Hz.

The ground collision warning is disabled when the backup sight mode is used.

BER mode warning

The BER warning is indicated by a flashing altitude warning light to alert the pilot of not setting the master mode selector to mode BER after landing. The warning appears when the aircraft deviates more than 12° from the course during touchdown (likely when the aircraft taxis off the runway).

TERNAV

The TERNAV system was added with the AJS upgrade as it uses the added data cartridge functionality and the increased processing power.

The TERNAV (terrain navigation) system uses the radar altimeter to detect the terrain contours below the aircraft, similar to TERCOM systems used for cruise missiles. These readings are then compared to a digital map sheet stored in the data cartridge. It serves as a parallel complement to the normal navigation system. The computer will continually observe the aircraft's movement along the terrain and will perform minor automatic fixes. The system also aids in providing an estimate of the current navigation error. Due to the function of the system, varying terrain features or isolated elevations aid in the system's understanding of the aircraft's position.

The system is largely automatic without pilot input and enables automatically on start-up.

Indication

If the data selector rotary is set to mode AKT POS, the 5th digit will display the status of the TERNAV system.

0 : TERNAV inoperable

1: TERNAV OK, but not sending any outputs. Stand-by mode. Aircraft is on ground or outside the area of TERNAV operation.

2: TERNAV OK, mode rough search. System is attempting to orient itself in a particular area.

3: TERNAV OK. Fine search. System in a higher resolution mode. Still ascertaining position.

4: TERNAV OK and following, but not used. Commonly seen in mode SPA

5: TERNAV OK and operating. System sending automatic fixes to the CK37 computer.

The TERNAV system can be toggled on/ off via the address system. Input 581000 in TAKT/IN, confirm with LS/SKU, and insert value 0 (580000) to enable TERNAV again)

Fuel calculation & Time keeping (Time on Target, time to waypoint)

The CK 37 will continually calculate time to the next waypoint, time on target, and the amount of fuel required to complete the flight as it is entered in the navigation system. During the planning stage, the pilot enters (or loads via data cartridge) a series of waypoints that constitute the planned flight and primary (and secondary if desired) landing bases.

Any of the waypoints may be designated a target waypoint. The target waypoints can have designated time on target wherein the desired time where the aircraft is supposed to be on the target can be set.

Ingress points

Ingress points are used to increase the Mach speed in the calculation for a particular phase of the flight that deviates from the optimal economic airspeed at low altitude. Ingress waypoints are used to set a higher airspeed in the assumed combat area that requires a higher airspeed, and can be used for the purposes of ingress and egress, however will be referred to as ingress speeds or waypoints.

The Mach speed is used for the calculations from the set ingress waypoint to the next set ingress waypoint. The last ingress waypoint speed will be applied until the primary landing base. If a target waypoint is after the ingress waypoint, the ingress Mach speed will only be applied until the target and economic airspeed after this.

Please refer to the “input of navigation data” section below on how to input ingress waypoints.

A: Last waypoint with a set speed is a target waypoint

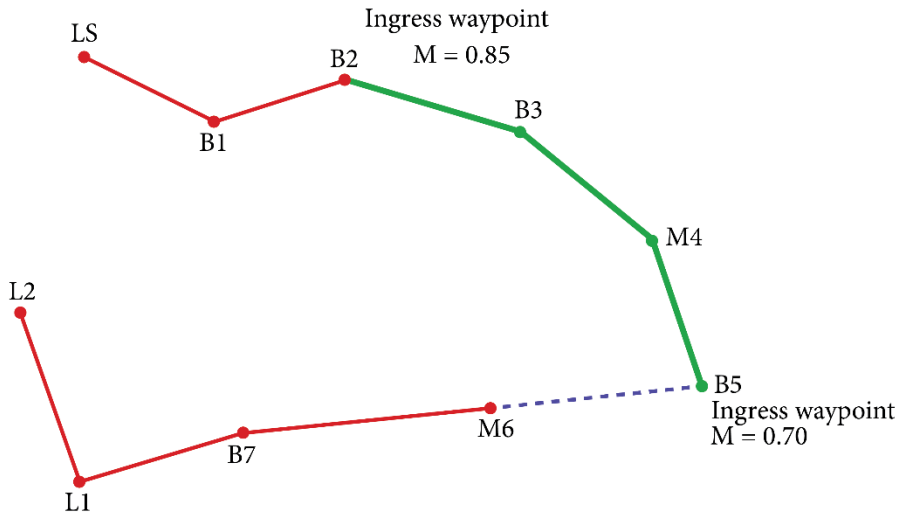

B: Last waypoint with a set speed is an ingress waypoint

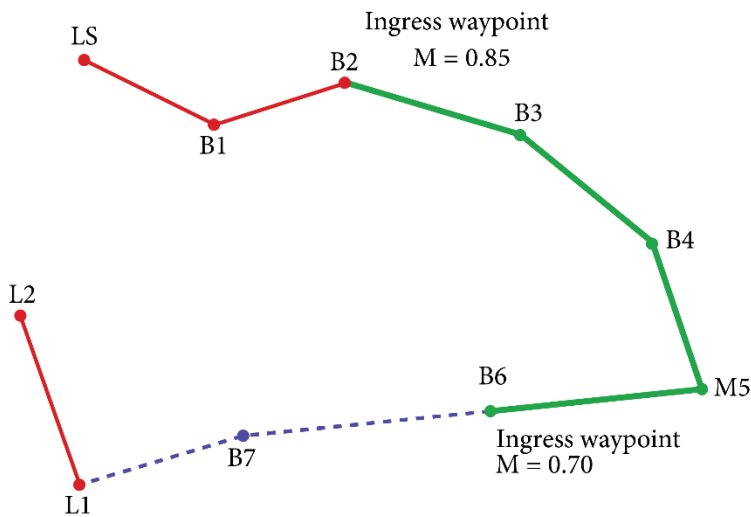

- Legs with an economic airspeed (Mach 0.55)
- Legs with a set ingress speed (Mach 0.85)
- - - Legs with a set ingress speed of 0.70)

Figure 126. Ingress speeds and waypoint logic.

Fuel calculations

The required fuel is continuously calculated and displayed as the amount of fuel required from the aircraft's current position to the next destination and the remaining route to the primary landing site (L1) and the amount of fuel required for a landing.



Figure 127. Fuel indicator. 87% fuel remaining. Striped “tie” indicating approx. 30% required to complete flight plan with fuel reserve included.

The striped hands indicate the currently needed amount of fuel to fulfil the planned flight as programmed into the computer. The computer accounts for the increased drag due to weapons and planned flight path and profile, taking into consideration the variables of ingress speeds and wind.

In addition, a pre-set fuel reserve is added to this calculation. This pre-set amount can be set by the pilot to ensure a greater margin.

Before take-off a 10% fuel requirement is added to fuel consumption. This corresponds to about 10 minutes of ground taxi, acceleration to Mach 0.55 and group re-join after take-off. These 10% are removed from the calculations after take-off as it is no longer required.

The fuel consumption calculation is based on the most economical airspeed (Mach 0.55 at the lowest altitude (sea level)). The most economical airspeed increases with about Mach 0.035 per 1000 metres of altitude. If ingress Mach speeds are entered in the flight path, the increased fuel consumption of these waypoints will be added to the fuel requirement. If the current destination is a waypoint after the last target waypoint, the fuel consumption is based on the current altitude and the most economical airspeed.

Economic airspeeds

Altitude (m)	Economic airspeeds (Mach)
0	M 0.55
3000	M 0.66
6000	M 0.76
9000	M 0.87
10000	M 0.9

Fuel reserve at L1

The fuel reserve is the minimum desired fuel state when reaching the primary landing position (L1). It can be set between 10 and 99%.

If no reserve is entered the default setting is 10% (the amount of fuel necessary for an approach and landing at the primary landing base).

If the secondary landing base (L2) is set, an extra fuel reserve is added to account for a flight between L1 and L2 at low altitude and at the economical airspeed as well as the addition of the same calculated fuel use to an approach and landing at the second landing site.

Input the desired value on Address 51, in percent. E.g. for 30% input 513000 in TAKT. Confirm with LS.

Note. The set fuel reserve amount is reset on Master mode BER after landing.

Fuel indication during mode SPA (Reconnaissance)

If mode SPA is selected the fuel is calculated to the current destination and from there straight to the primary landing base (L1), including the necessary fuel required for approach and landing, along with the addition of the fuel reserve. This is due to the aircraft not likely flying along the set track during the reconnaissance phase of the flying.

Timekeeping calculations

The computer calculates the following in regards to timekeeping: Flight time to target, Time error on target, and Timetable deviation. A certain margin is added to the calculations to allow changes of course and airspeed.

3

Flight time to target waypoint

Flight time to target waypoint is the time calculated to fly from the current position to the current destination waypoint with present airspeed and then further along the navigation polygon to the next ingress speed waypoint with present airspeed.

After the ingress speed waypoint, the ingress airspeed are used for the flight time calculation for the flightplan (including other target waypoints) until a target waypoint with a set time on target.

If no time on target is set, the calculation is used until the first target waypoint in the sequence.

If one of the BX points is selected as the destination, the calculation is for the previous waypoint in the polygon.

Flying time to target serves as a reference to time error on target calculations, and is only presented if no time on targets are set. If a time on target has been set, a timetable deviation is presented instead.

Time error on target

Time error on target is the deviation between the calculated time on target and the planned time on target. This is calculated for the closest target waypoint with a set time on target. If no time on target has been set deviation is not calculated.

Timetable deviation

The difference between the time it takes to fly the entire route from the current position to the current destination waypoint and then along the navigation polygon as planned, to the target with the planned airspeed and the time that remains to the time on target is called the timetable deviation.

Indication

Current time and timekeeping information is displayed both in the data panel and in the HUD with the Airspeed Deviation Fin.

Data panel

Mode TID (Time) / OUT

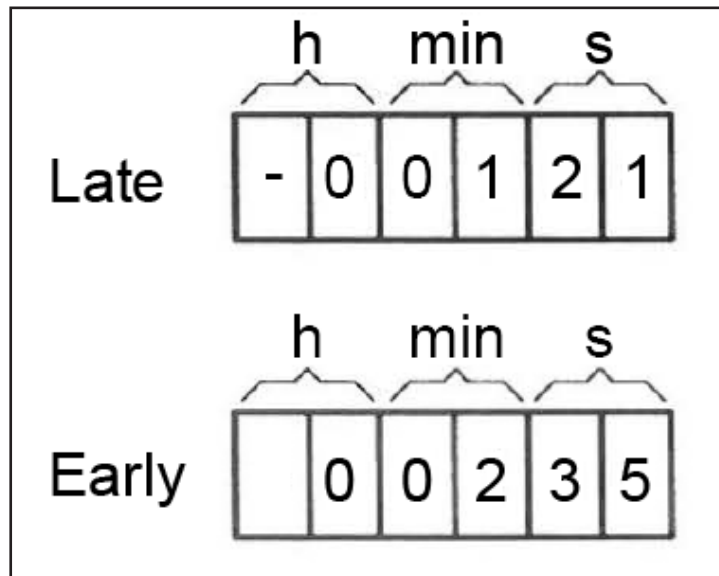

Figure 128. Time on Target set

If a time on target is set, the data panel display the current time error in mode TID / OUT. The error is displayed in hours, minutes and seconds. A negative error ("behind schedule", estimated time of arrival later than set time on target) is displayed by a minus sign in front of the hours (first digit). A positive error (ahead of schedule) by a blank first digit. Thereby, keeping the display at 0 will ensure an exact arrival on the set time on target.

No time on target set (Time to waypoint mode)

In case at time on target is not set the data panel will display to current flying time to current waypoint based on current airspeed. This is displayed by the number 7 displayed in the first digit.

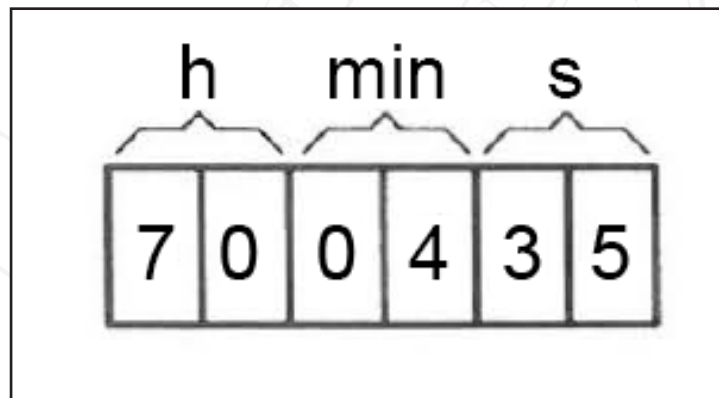

Figure 129. No time on target set. 4 minutes, 35 seconds to waypoint.

Neither mode takes into account any planned pop-up waypoints attached to the target.

Take-off time

If the aircraft is on the ground and a Time on Target is set, a planned take-off time is indicated. An empty first digit indicate time to throttle-up on take-off and a minus sign indicates the time after take-off should have occurred. Display is very similar to that of the normal readout with a time on target set.

Current time

Current time is displayed if the navigation button LS is pressed and held.

Time on target

Displays entered Time on Target if the corresponding target waypoint button (B1 – B9) is pressed and held.

RB 15 timekeeping (missile on target)

The RB 15F missile can be planned to impact the target on a certain time similar to the Time of Target planning. Here, the relevant Time on Target becomes the release point. Input the desired impact time (may differ due to seeker function) on button BX.

Airspeed Deviation Indicator “fin”

The airspeed deviation fin in the HUD will display an abstracted predicted airspeed required to reach the designated time on target. The fin can be displaced a maximum of its own length, and a full extension corresponds to an error of about 20 – 30% of the calculated flying time to the target. Thereby, the fin will rescale and display varying error times for the same amount of extension dependent on the distance to the target.

The calculation assumes that if an ingress waypoint is set along the route, the ingress speed will be held during that portion of the route.

A “high” fin indicates a positive time error = too early arrival, reduce airspeed.

A “low” fin indicates a negative time error = too late arrival, increase airspeed.

Popup points

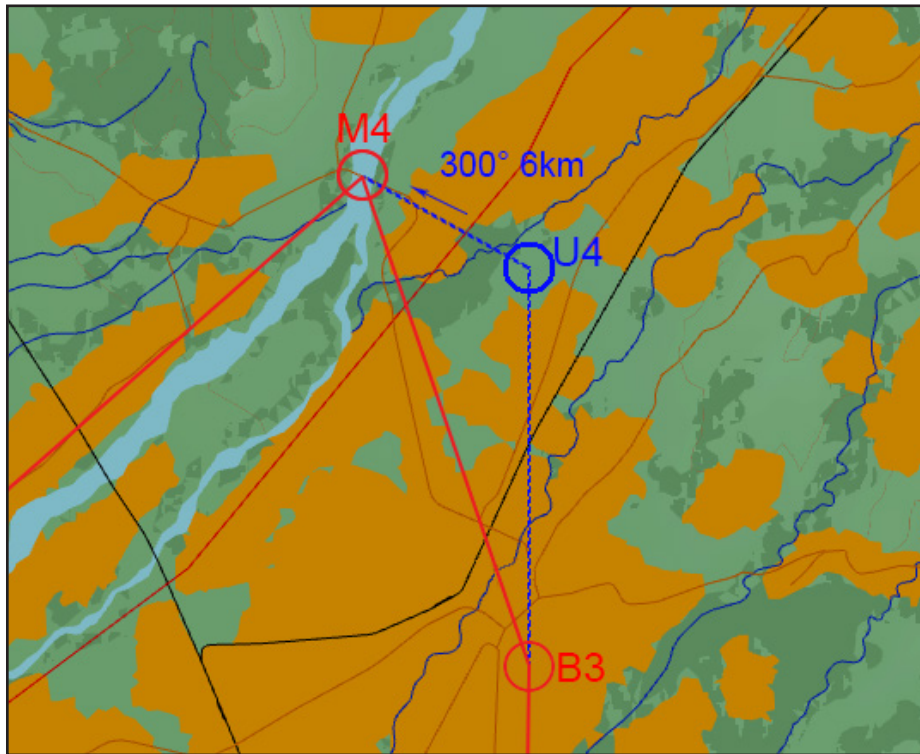

Figure 130. Popup points. Popup point set, 300 degrees approach, 6 kilometers distance.

For certain ground attack missions, it may be relevant to input a popup point. Popup points are defined as a position relative to a target waypoint (M) with a heading *from* the popup point (U) *towards* the target, as well as a distance.

Please refer to the “input of navigation data” section for further details on the specifics of input.

Steering order towards the popup point is given under the assumption that it is selected automatically by passing the waypoint before the target waypoint, or manually by selecting the target waypoint as a destination.

Note that pressing the waypoint button twice will select the waypoint instead of the popup point. Additionally, master mode NAV and a SAFE trigger are required.

When the steering order is given towards the popup point, a red U is displayed in the destination indicator. Steering order is displayed on the ADI flight director needles and in the HUD. The course heading bug on the course ring and destination indicator will indicate heading towards and distance to the destination waypoint as usual.

The HUD symbology comes in the form of a timeline with markers. The time line appears 40 seconds before the popup point is reached, and then shrinks with such a rate that it reaches the markers when the popup point is overflown. If the LOWNAV HUD mode is used, the course scale and timeline with markers remain visible. The course scale remains even after the popup point is overflown.

Steering order towards the target (white M in the destination indicator) is given automatically when passing the popup point, or manually by pressing the waypoint button for the target in mode AKT POS, switching to master mode ANF or setting trigger to UNSAFE. If a steering order towards the popup point is once again desired, the previous waypoint button is pressed and then pressing the waypoint button for the target waypoint with a popup point attached.

Steering order towards the popup point is not affected by a radar target fix.

Cockpit display of popup points

3

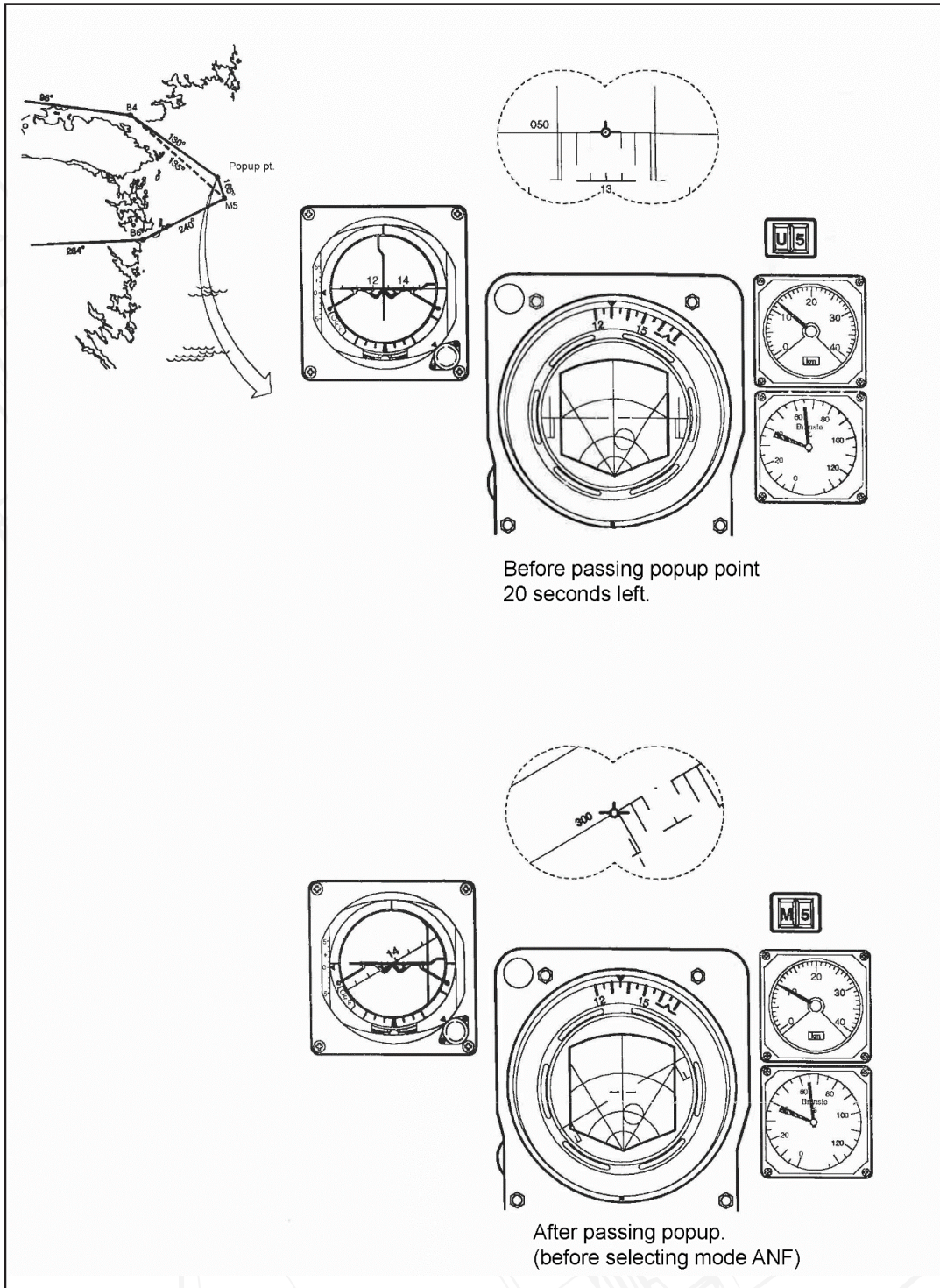

Figure 131. Display of popup points.

Input of navigation data

Data input can be done if the AC power is on, that is if either the ground power is connected or the engine is running. Normally, the data cartridge loads the set of waypoints and relevant mission information into the computer. While the data cartridge will load the waypoints, information such as designating target waypoints and setting ingress Mach speeds will have to be done manually.

The data panel is used for input. The 10 digits on the keypad are used for inputting the numbers that are displayed on the data display on the top of the data panel.

All inputs are done by setting the IN/ OUT (IN / UT) switch to the IN position, all outputs to the OUT (UT) position.

Modes will be stated in this manual as "AKT POS / OUT" for mode AKT POS and the IN/ OUT switch in mode OUT.

Clearing the data indicator, for example if a wrong number is entered is done via cycling the IN/ OUT switch.

The following input / output information will be in regards to navigation mode only.

Please refer to the data input / output chapter of the procedures section for further information

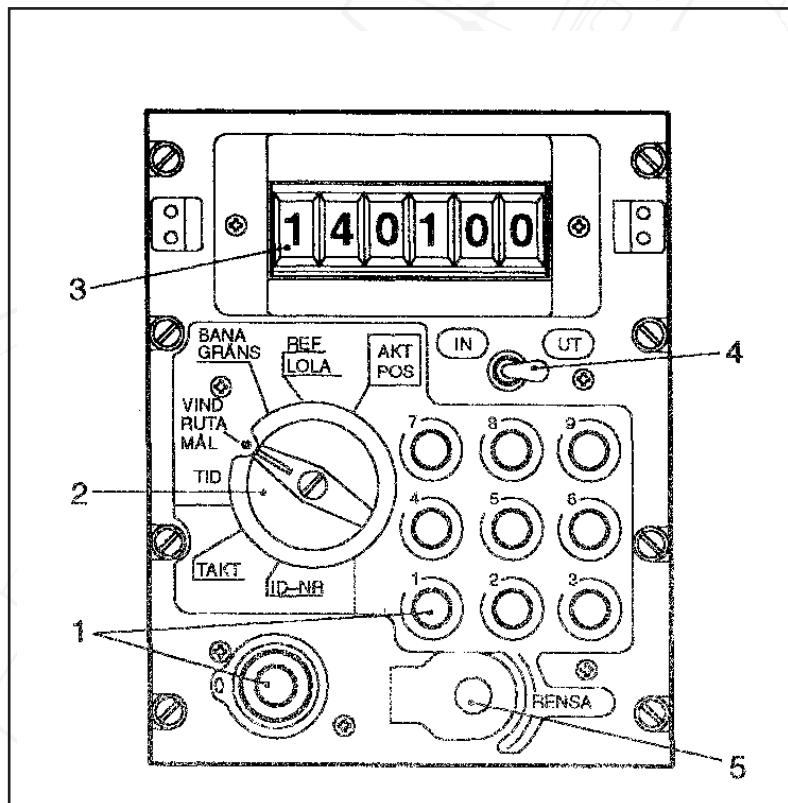

Figure 132. Data panel.

AKT POS

No input in this mode. Output indicates current position in mode OUT. Indicates in Longitude and Latitude (or reference number).

Input REF/ LOLA

Used to input coordinates of waypoints, take-off and landing bases.

To make inputting coordinates easier, a set of reference numbers is pre-stored in the computer's memory. Thereby, a 4 digit code corresponds to inputting 6+6 digits of longitude and latitude as well as connecting to other information regarding that locations, such as TILS channels or runway headings.

Landing bases (airbases or airfields, or other landing sites) always begin with the number 9, followed by a 0 and then two digits corresponding to each airfield, for example 9014.

Please refer to the in-game kneeboard or attached appendices documentation for further details and list of reference numbers.

Inputting coordinates on a particular waypoint slot is done by entering the coordinates or reference number and then pressing the button corresponding to the desired waypoint (B1 – B9).

Inputting a reference number for landing bases L1 and L2 is done by using the button L MÅL. Alternate landing site (L2) is entered by adding the number 9 on the second digit. For example. Batumi as an alternate site is entered as 9901 and then pressing L MÅL. If L1 is not entered, the start base LS is entered automatically in this slot.

Clearing entered landing base or alternate is done by inputting 9000 and 9900 respectively.

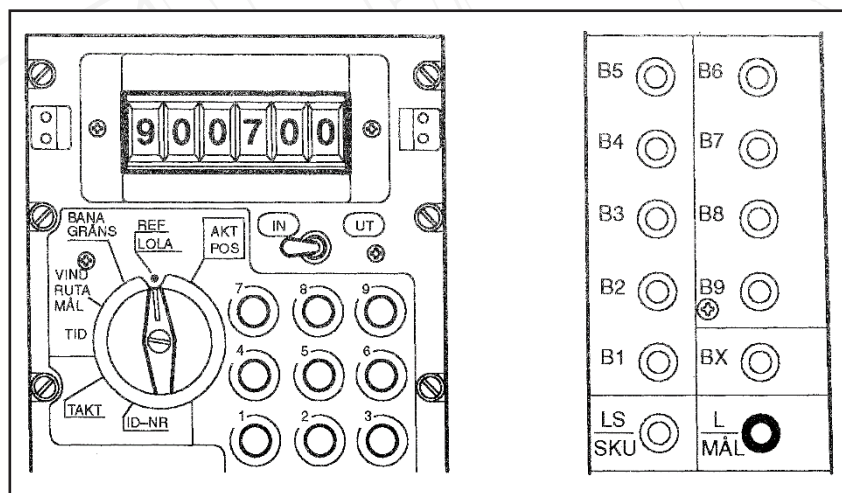

Figure 133. Airfield number 7 entered as a primary landing site.

Positions for Take-off (LS), Landing bases (L1, L2), navigation waypoints (B1-B9) and mark points (BX) can also be entered as Longitude and Latitude. Coordinates should be entered as Longitude DDMMSS, Latitude DDMMSS (*D: Degree, M: Minute, S: Second*).

Note: This is the reverse order of inputting coordinates to what you may be used to.

For example, Batumi airport on the Black sea map: E 41°, 35' 48" N41° 36' 36" is entered as 413548 413636.

After inputting the first set of 6 numbers (longitude), the display will go blank and allow the second set of numbers (latitude). After inputting the full 12 digits, the data indicator will cycle between the longitude and latitude. Press the desired waypoint button to add the coordinates to that slot.

In the output mode, The first digit will flash to indicate that it is the latitude number, to be able to differentiate the two numbers.

BX mark points are added in the same manner, but after pressing BX, press a number of the data panel. E.g. for BX2, input coordinates, press BX and then number 2 on the data panel.

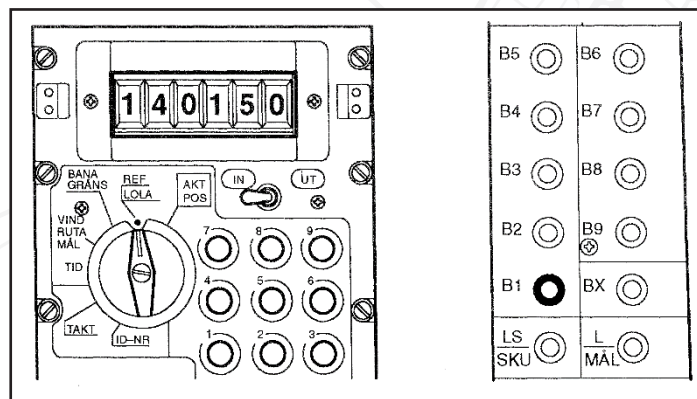

Figure 134. Longitude for waypoint B1. 14 degrees, 01 minutes and 50 seconds.

Waypoints (B1-B9) that have not been assigned coordinates have the previous waypoint's entered coordinates loaded. This does not apply for the landing bases and the mark points (BX). If coordinates are not entered on L1, the coordinates of LS are transferred, along with the TILS channels and main runway heading. The alternate landing base L2 can only be entered as a reference number, cannot be entered as longitude and latitude.

Input BANA/ GRÄNS

For inputting headings for runways that are not set via reference numbers, the data selector is set to BANA/ GRÄNS. The runway heading is entered as degrees and decimal if applicable on the first four digits of the data panel and then confirmed by pressing the waypoint button LS or L MÅL (depending on whether a start base or landing base is being entered).

If the runway has a TILS unit, the channel is entered on the two last digits while adding the runway heading.

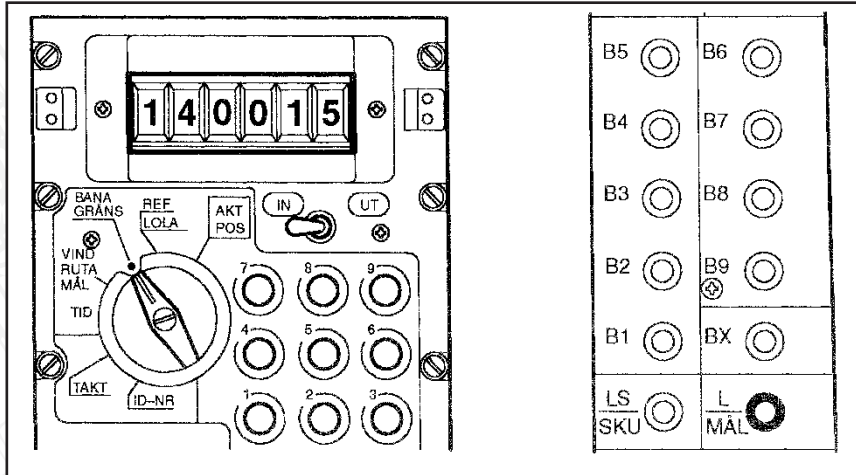

Figure 135. Runway L1 140.0°, TILS channel 15

Runway heading and TILS channel for the alternate landing site L2 cannot be entered manually.

With the data selector in mode BANA / GRÄNS, boundary lines can be set on every navigation waypoint (B1-B9), for the purpose of setting for example planned route to a waypoint. Input is made by entering a heading towards the waypoint, similar to how the runway heading was set. The first three digits are for the first line, the last three for the second line. If only one line is desired the last three digits are left blank.

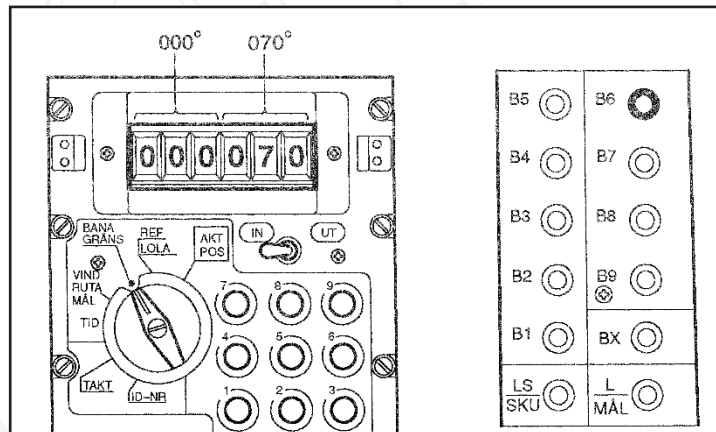

Figure 136. Input of boundary 000 (north) and 070 (south-west)

Inputting a zero (0) will reset ALL boundary lines on the waypoint.

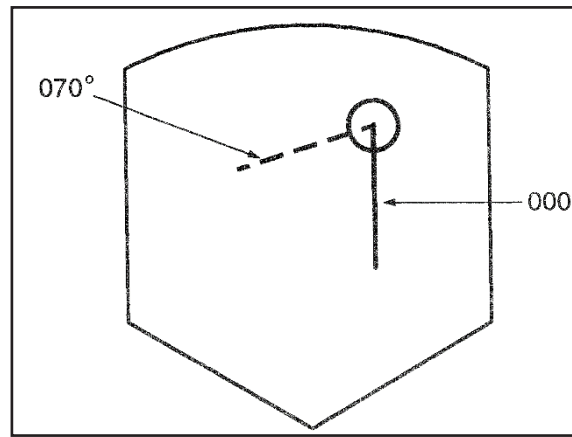

Figure 137. CI symbology of boundary lines.

The entered lines are displayed on the destination circle marker on the CI (radar scope) in master modes NAV and SPA and radar mode A0 and A1. If only one line is entered, the line is turned on continually, and if two lines are entered, they will alternate every 2 seconds. The lines disappear if the circle marker is parked against the side of the display area.

Input VIND/RUTA / MÅL

Normally, the Doppler unit is used for calculating the current wind, but when inputting forecasted wind, the following applies:

- Forecast entered in the air has priority over Doppler wind.
- Forecast entered on the ground does not have priority over Doppler wind. Doppler wind is used when available, but otherwise forecast wind is used.
- Forecast wind is always used for fuel / time calculation during take-off, that is as long as $M < 0.35$.

Inputting forecast wind is done by setting the data selector to mode VIND/ RUTA / MÅL. Wind direction is given in degrees on the first three digits of the data indicator. Wind speed is entered on the following two digits in km/h (highest being 99 km/h). The input is entered by pressing LS

1 m/s = 3.6 km/h.
1 knot = 1.852 km/h

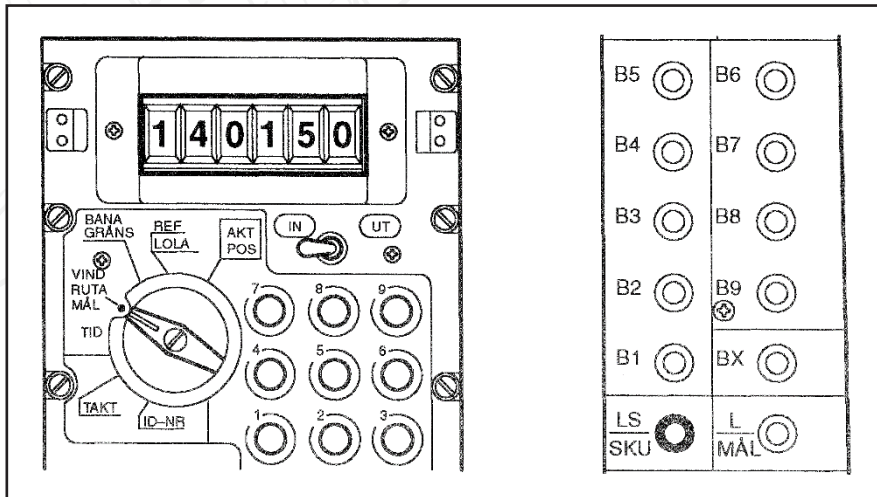

Figure 138. Forecast wind 140°, wind speed 15 km/h

The forecast wind can be reset by setting the wind direction and speed to zero (000000). It is also reset after landing and setting the master mode switch to mode BER.

The MÅL/RUTA reconnaissance function will be addressed in the reconnaissance chapter of the procedures section.

Input TID

With the data selector in mode TID, the current time, time on target and ingress Mach speeds can be set. Inputting current time is done by entering the time in hours, minutes and seconds and pressing LS.

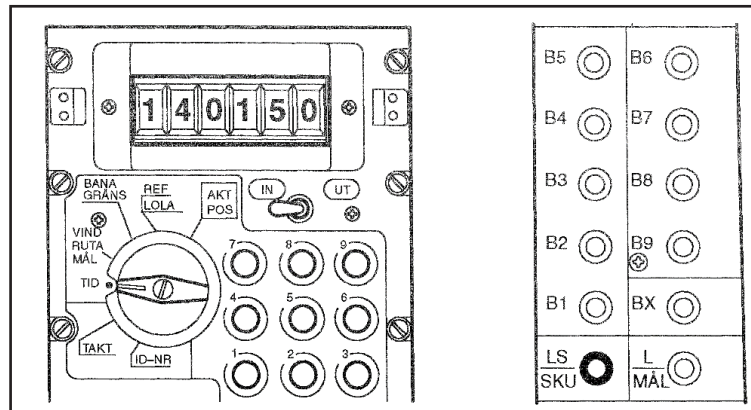

Figure 139. Current time 14:01:50

Inputting time on target is done by entering the time in hours, minutes and seconds and pressing the desired target waypoint

Ingress speeds are entered as a Mach number on the first three digits of the data indicator, where the first digit is an integer and the second being decimals.

For example: a desired ingress speed of Mach 0.95 is entered as 095. The input is entered by pressing a waypoint button not corresponding to a target waypoint.

Multiple ingress waypoints can be set with different airspeeds. Entered ingress speed is calculated to last until the next set ingress waypoint or the next target waypoint with a set time on target. If there is no target waypoint after the last ingress waypoint, the ingress speed is set until the primary landing site.

To prevent input of unrealistically high Mach numbers, the computer will not accept Mach numbers over Mach 3.99 (highly unrealistic speeds). Please note the restrictions imposed by the airspeed envelope of the aircraft and high fuel consumption during afterburner use at low altitude. In general, it is advised to avoid usage of mach speeds above 0.90 for calculations, even lower speeds should be used for heavier / higher drag loadouts to provide sufficient margins to increase / decrease speed.

Economic airspeeds for calculation of fuel requirements is obtained at input of ingress speed of M 0.55. In the fuel calculation, the airspeed used to calculate is never higher than an ingress speed of 0.85.

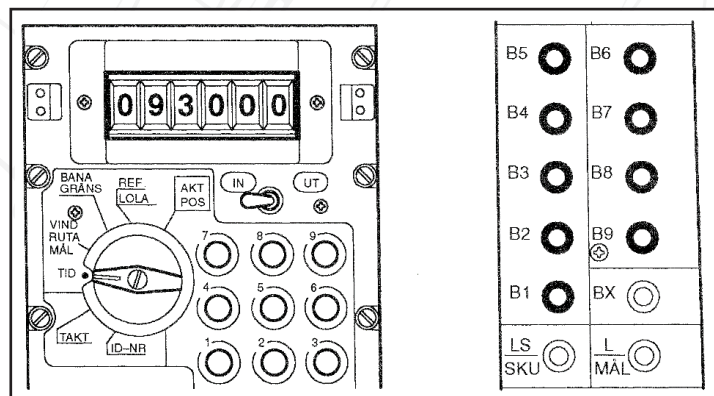

Figure 140. Ingress speed Mach 0.93.

Input TAKT

With the data selector in mode TAKT, the pilot can among other things define waypoints as target waypoints, input fuel reserves and enable / disable TERNAV.

Fuel reserve is entered via address 51 on the second pair of digits as a percentage. Input is confirmed by pressing the LS button.

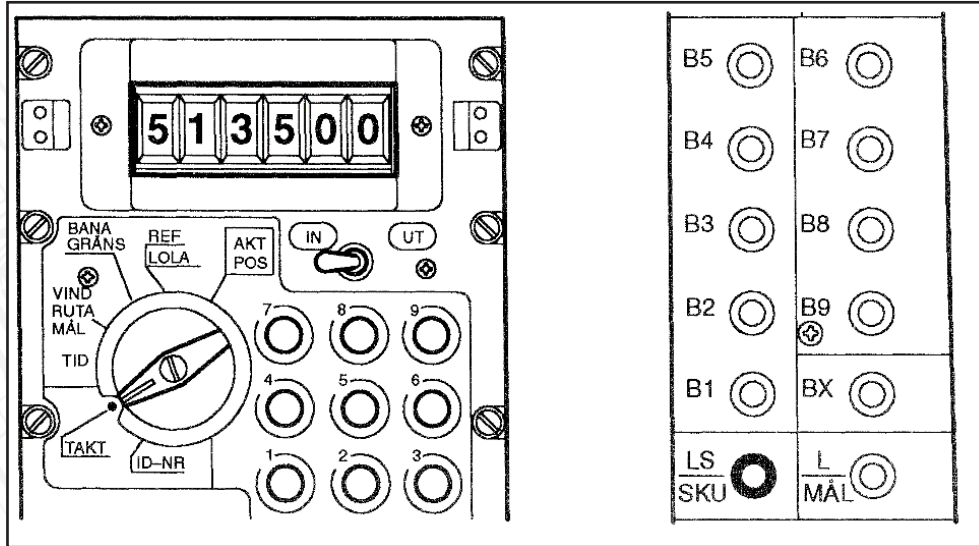

Figure 141. Fuel reserve of 35 %.

Target waypoints

A target waypoint is defined by either

- Inputting the number 9 and then pressing the desired waypoint.
- Defining a pop-up point towards the desired waypoint.

The input is entered by pressing a waypoint button. So waypoint B5 becomes target waypoint M5. Multiple target waypoints can be set.

To restore a target waypoint to a normal navigation waypoint, input the digit 0 and press the waypoint button.

Mode TAKT is also where a number of addressed data values are stored. *Please refer to the input/ output chapter of the procedures section for further details.*

Pop-up waypoint

A popup waypoint is set in reference to a target to facilitate attack planning and flight towards the target. Each target waypoint can have a pop-up point assigned to it.

Popup waypoints are set by a heading (in degrees) and distance (in whole kilometres, 1- 99km) from the pop-up point to the target point. The input is entered by pressing the waypoint button corresponding to the target waypoint.

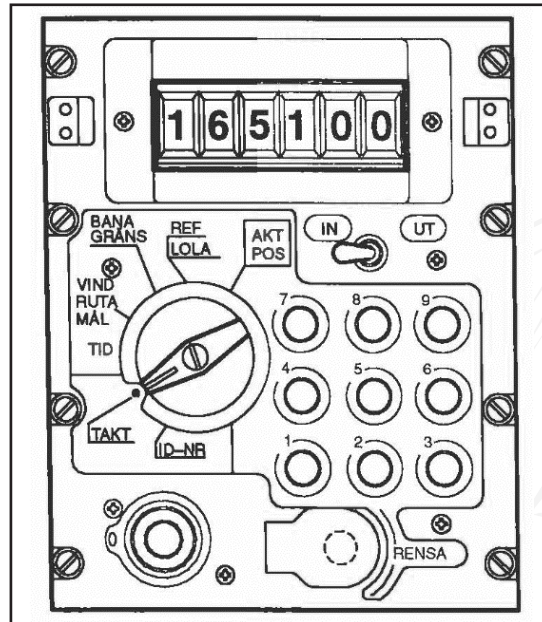

Figure 142. Defining a pop-up point. Heading to target waypoint 165°, distance 10 km

Input ID-NR

No function in simulator. Used in real aircraft for defining information for recording mission data.

Data cartridge loading

The pilot can start the data transfer from the data cartridge by setting the data selector to REF/LOLA and inputting the code 9099 and pressing LS / SKU to confirm. The data cartridge can only be loaded when the aircraft is on the ground.

3

Important

The cartridge needs to be inserted into the slot in order to be loaded. The cartridge is inserted by clicking the data cartridge slot on the rear left wall.



Figure 143. Data cartridge slot

Loading the cartridge will automatically clear entered mission data as well as TAKT addresses 20- 92.

During data transfer, the entered code 909900 is shown in the data indicator, with the first 9 flashing. A failed transfer is indicated by the first 9 no longer flashing and the display showing 909900. A successful transfer is indicated by the data indicator displaying 000000.

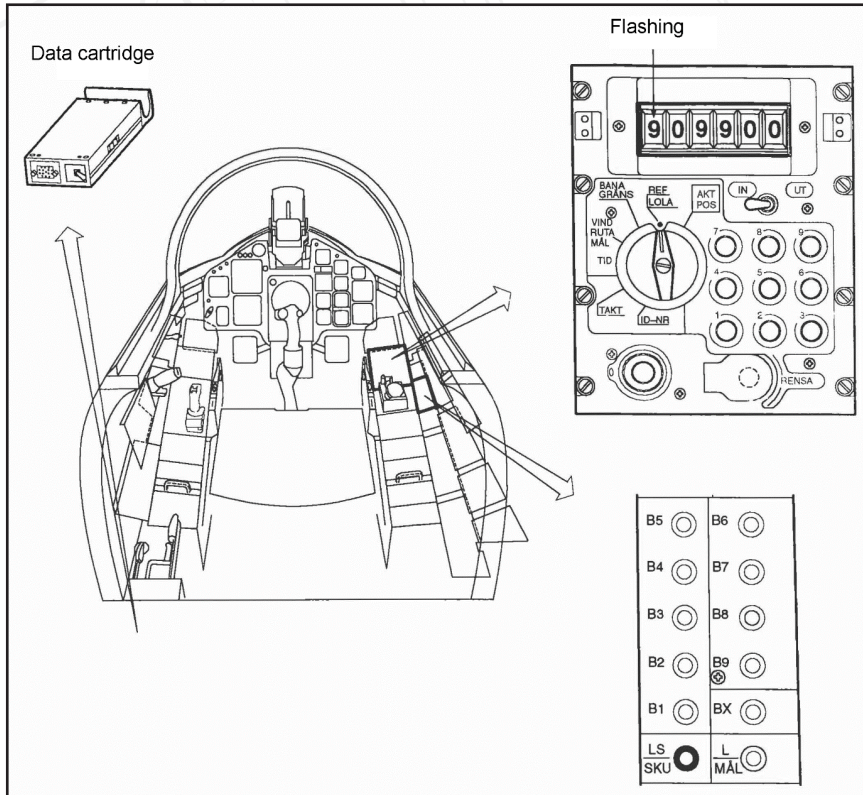

Figure 144. Data cartridge loading.

Plausibility test

After inputting mission data, a plausibility test should be done to validate the inputs. This is done by setting so called “control fixes”, where one cycles through the waypoints along the entered navigation polygon. During this simulation, the length and heading of each leg is checked against the own navigation calculations.

The test is performed by setting the master mode selector in mode BER and the data selector in AKT POS / OUT.

The waypoint button LS is pressed and the fix trigger is pulled to the second detent (TV). The navigation system now assumes that the aircraft is at the take-off position. Then the B1 button is pressed. The destination indicator now displays B1. The distance indicator shows the distance between the start base and the first waypoint, B1. The course indicator on the course ring indicates the heading towards the waypoint. The fuel indicator indicates the amount of fuel required for the mission.

The next leg of the navigation polygon is checked by pressing the next waypoint in the series. A similar indication will be displayed as for B1. By comparing the fuel requirements between B1-L1 with the fuel requirements for the distance LS-L1 the calculated fuel requirement for LS-B1 is obtained.

The plausibility test is ended by a fix on LS to obtain the correct position. If this is not done, the start base coordinates are eventually set automatically when the data selector is set in mode TID or the master mode selector is set to NAV.

Output of navigation data

Output of mission data is made by setting the IN/ OUT (UT) switch to OUT (UT).

The information is displayed on the data indicator, and positions without information are displayed as zeroes (0).

Output AKT POS

With the data selector in mode AKT POS, the aircraft current position according to the navigation system will be displayed. The indicator alternates every second between displaying longitude and latitude. The first 4 digits indicate the current degrees and minutes.

The fifth digit indicates the TERNAV status. *Please refer to the TERNAV section for the different numbers and their use.*

The sixth (last) digit indicates the navigation systems estimation of its position error (the distance between the own position and the “true” position) in kilometres.

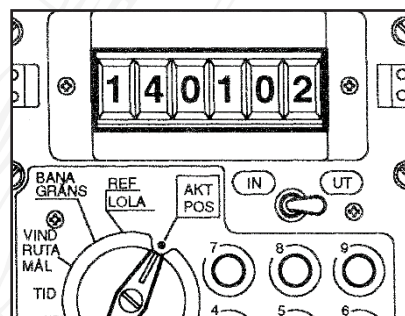

Figure 145. Current longitude 14° 01'. TERNAV inactive. Calculated position error < 2 km

Output REF LOLA

In REF LOLA, the reference number or longitude and latitude for the current destination is displayed. If any of the waypoint buttons are pressed and held, the coordinates (or reference number) for that waypoint are displayed.

If the waypoint button L MÅL is held, the reference number or coordinates of the primary landing base are displayed alternating with the reference number for the alternate landing base.

Coordinates for mark points BX1-9 is displayed by pressing the corresponding of the mark point on the data panel.

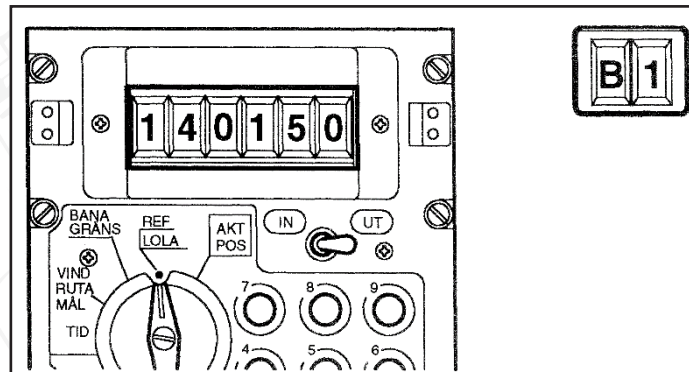

Figure 146. Longitude for waypoint B1, 14°, 01' 50".

The data indicator displays the reference number with six digits or the longitude / latitude in degrees, minutes and seconds. Longitude and latitude display alternate every two seconds.

The first digit will flash to indicate that it is the latitude number, to be able to differentiate the two numbers.

Output BANA / GRÄNS

When the data selector is in mode BANA/ GRÄNS, the entered runway headings and TILS-channels for take-off and landing bases can be displayed, along with the boundary lines for waypoints.

If no waypoint button is held, the display is for the current destination. If LS, L1 or L2 is the destination the runway heading and TILS channel are displayed. If B1 – B9 is the destination, the boundary lines are displayed.

Display for the bases and waypoints (B1-B9) that are not the destination is obtained by holding down the waypoint button. If waypoint button L MÅL is held, the display alternates between runway heading and TILS channels for L1 and L2.

Selected runway heading on bases LS, L1 and L2 can be set to a reciprocal heading or another runway by the “alternative runway heading switch”. This is done in mode AKT POS by setting the base as a destination, and then in mode BANA/GRÄNS pressing in the base waypoint button. For every press of the button, the next runway is selected beginning with the next highest runway number.

If the base is entered via a reference number, all runway directions on that base are available. If the base has been entered via longitude / latitude and a runway heading only the reciprocal heading can be found. Alternate runway headings are displayed by the L flashing on the destination indicator.

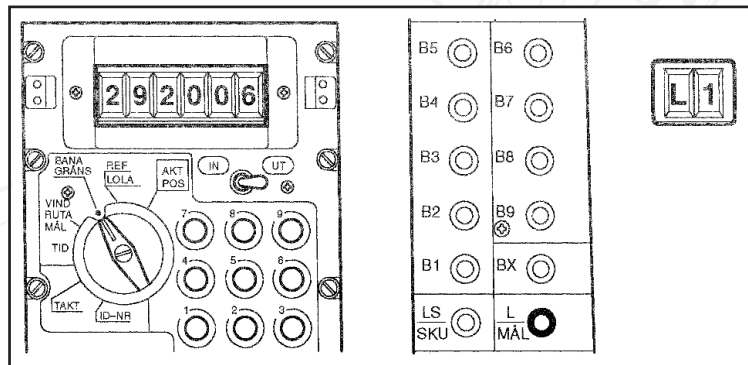

Figure 147. Runway heading 292°, TILS channel 06

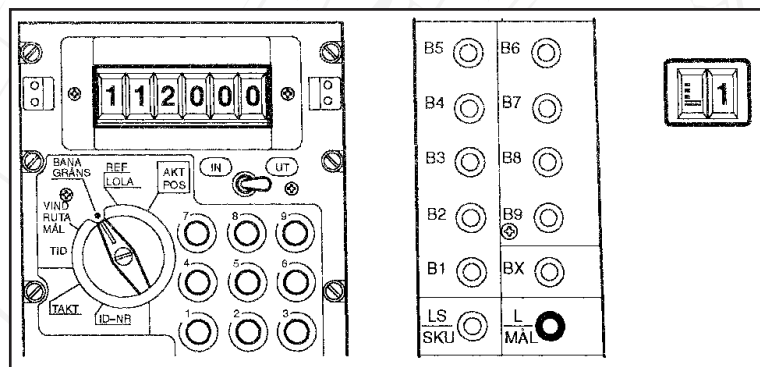

Figure 148. Reciprocal runway heading 112°, TILS system not available.

3

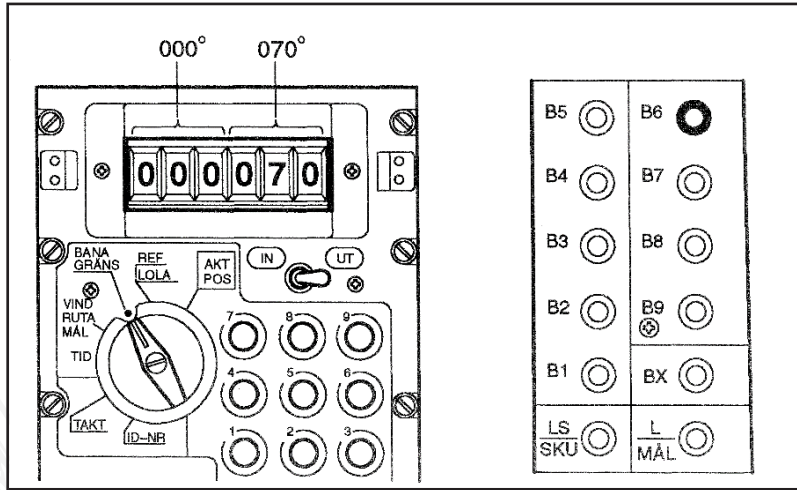

Figure 149. Output of boundary line at waypoint B6

Output VIND/ RUTA / MÅL

When the data selector is in mode VIND/ RUTA / MÅL, the data indicator normally displays the wind used for the navigation calculations. The data indicator's first three digits displayed is the wind direction. The fourth and fifth digits display the wind speed.

If the Doppler wind is displayed, the last digit is a zero (0). If the forecast wind is used the last digit is a minus sign (-).

If the waypoint button LS SKU is pressed, the forecast wind (if entered) is displayed.

The MÅL/RUTA reconnaissance function will be addressed in the reconnaissance chapter of the procedures section.

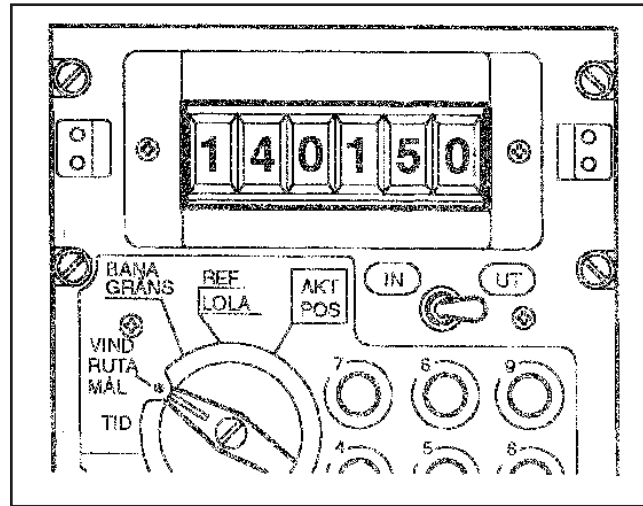

Figure 150. Wind 140°, wind speed 15 km/h, last digit indicating wind is derived from the Doppler system.

Output TID

With the data selector in TID, the current time, time on target, calculated flight time to target and ingress Mach speeds can be displayed.

Current time

Current time is displayed if LS is pressed and held.

3

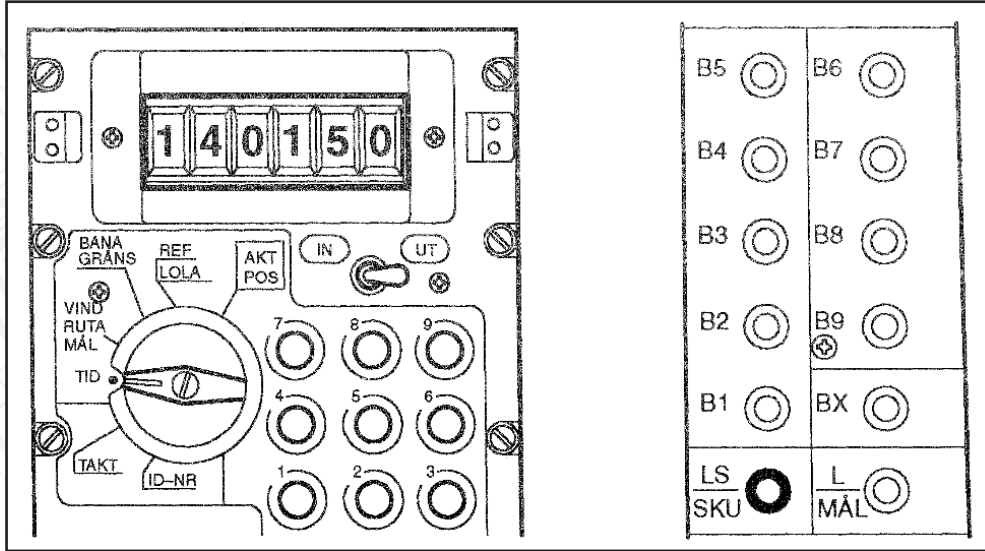

Figure 151. Current time 14:01:50

Time on target

Entered Time on target is displayed if a waypoint button corresponding to a target waypoint is pressed and held.

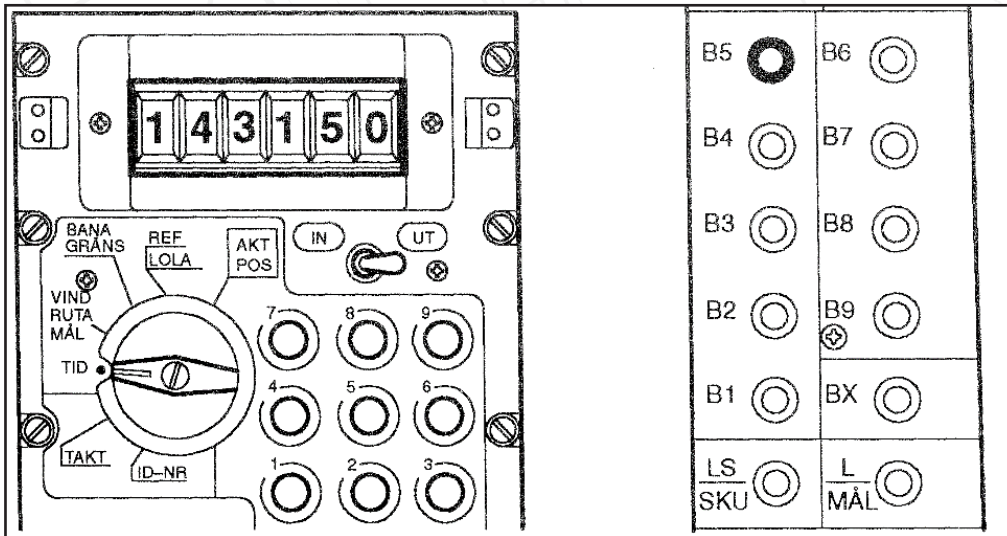

Figure 152. Time on target 14:31:50 on target waypoint M5

Timetable deviation

Timetable deviation, the deviation of the current estimated arrival compared to the Time on Target, is displayed if no waypoint button is pressed, on the condition that at least one Time on Target is set.

The deviation is displayed in hours, minutes and seconds on the last 5 digits in the data indicator. If the calculated deviation is behind schedule, this is indicated by a minus sign in front of the time, and if the aircraft is ahead of schedule, the first digit is empty. Before take-off, the remaining time to take off is displayed in the same manner.

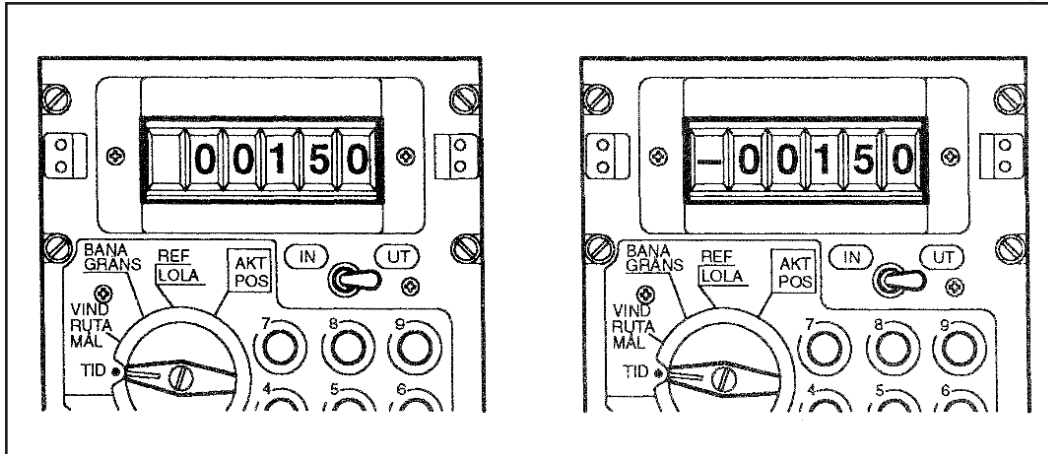

Figure 153. Time table deviation, 1 minute 50 seconds ahead, and behind schedule.

Calculated flight to time to destination

Calculated flight time to destination is displayed if no waypoint button is pressed and no Time on Target is set. This mode is indicated by the number seven (7) shown in the first digit on the data indicator.

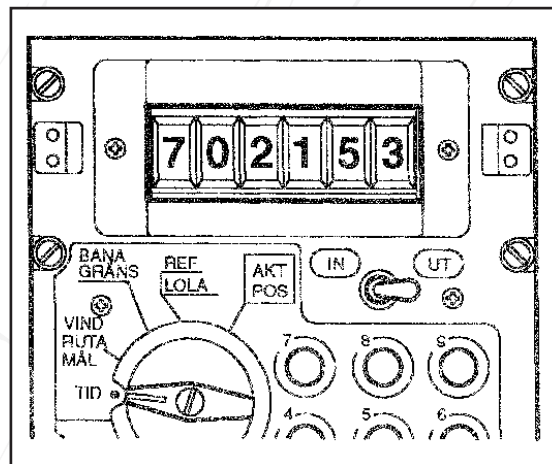

Figure 154. Flight time to destination 21 minutes, 53 seconds

Ingress Mach speeds

Ingress Mach speeds are displayed if the waypoint button for an ingress waypoint is pressed and held. Ingress Mach speed is displayed as a whole number and two decimals (ex. Mach 0.75).

3

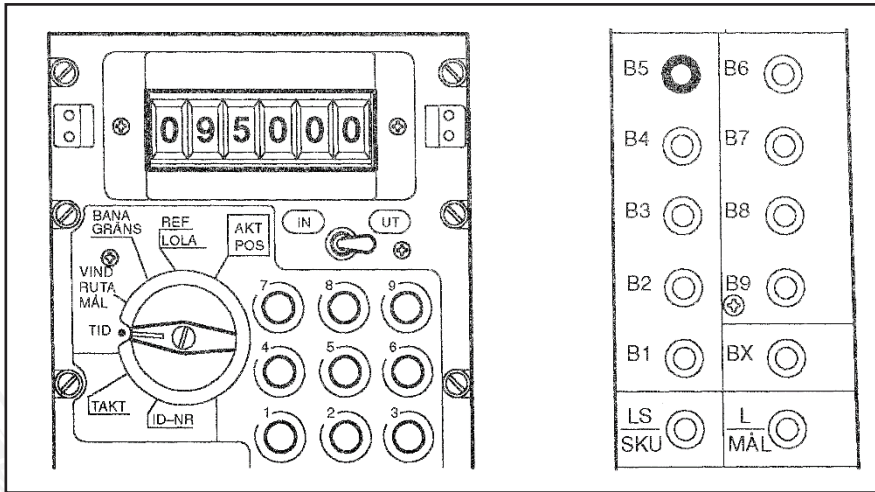

Figure 155. Ingress Mach speed M 0.95 from waypoint B5

Output TAKT

With the data selector in mode TAKT, whether or not a waypoint is defined as a target waypoint can be determined, and what the fuel reserve is set to.

The waypoint is checked by pressing a waypoint button. If the data indicator indicates 900000, the waypoint is defined as a target waypoint.

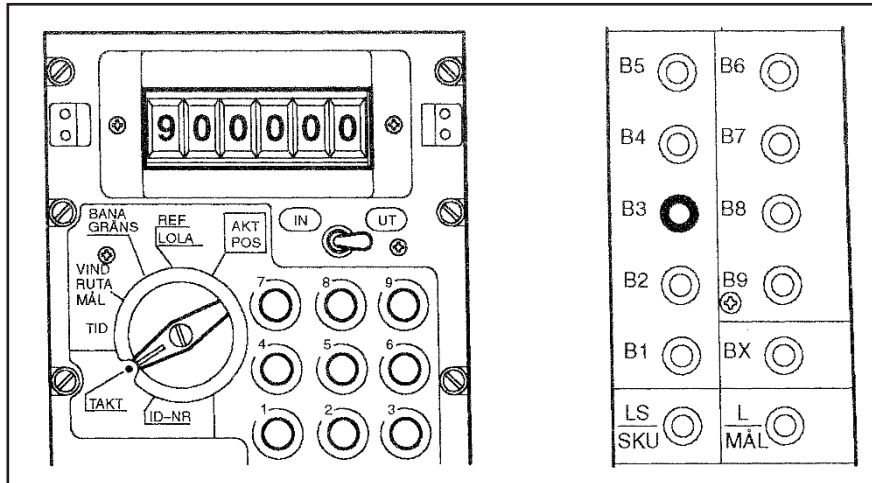

Figure 156. Waypoint B3 is defined as a target point, M3

The entered fuel reserve is displayed by setting the mode TAKT/IN and inputting 510000 and then switching to mode TAKT/UT.

Output ID-NR

No function in DCS.

Used in real aircraft for mission data analysis and maintenance.

Please refer to the Input/ output chapter of the procedures section for further information.

Radio systems FR 22, FR 24

The aircraft is equipped with two radio devices:

FR 22

The primary radio, FR 22 is a combined VHF/UHF radio with 844 pre-stored channels, and has also the ability to set frequencies manually.

It has an output by 20W for VHF and 10W for UHF.

Frequency span within VHF is 103.000 – 155.975 MHz with 25 KHz intervals, and UHF 225.00 – 399.95 MHz with 50 KHz intervals.

The frequency can be either set through preset channels on the FR 22 control panel on the side panel or by use of the frequency panel on the front panel.

The FR 22 is powered by the main power supply from the generator (and ground power).

Only one of the pushbuttons on the panel can be pressed at a time, and it will push back any other button previously held.



Figure 157. FR 22 radio selector panel Channel A on Base 06 selected.

Group selector

The group selector is used to set one of the different preset channels, normally used for contacting fighter controllers or inflight communication. Channels are chosen by setting the dial on the left, then pressing one of the 0-9 buttons on the lower half of the panel to set the chosen channel on the dial.

Developers note:

Due to in-game limitations with the number of presets, only a certain number have been added to DCS.

Base selector

The base selector is used to select preset frequencies for contacting Air Traffic Control. Frequencies are selected by moving the right dial to the corresponding airport / airbase number. The letter buttons (A/G, B, C/F, C2, D/E) on the second row are used to select the different channels for that airbase / airport.

Every sixth position of the selector knob will display the mode ALLM (Allmän / Common) which will change the function of the letter channel selectors to correspond to the FR24 channels G, F, E.

Please refer to the ingame kneeboard for airfield frequencies and their corresponding channels.

Special preset channel buttons

The top row of buttons are the special channel selectors which are independent of any of the group or base channel selector dials.

H – Guard channel 121.5 MHz.

The three middle buttons are quick preset buttons (presets 1,2,3).

The Minus button (-) will bypass the selected channel and enable the frequency selector on the front panel.

Frequency Selector

The frequency selector is used for setting the frequencies manually. The frequency selector requires the minus button (top right on the FR22 panel) pressed in order to be active.

The two knobs each control a group of three off the digits and each knob has a inner and an outer section. The inner section of the left knob controls the first two digits (21), and the outer the last (7). The inner right knob changes the first digit (2), and the outer the last digits (50) in increments of 25.

3



Figure 158. Frequency selector (UHF 217.250 MHz)

Please refer to the appendix for the radio channels for airbases. Can also be found in the F10 menu as well as the in-game kneeboard.

FR 24

The backup radio FR 24 is a VHF AM radio with an output of 3 Watt. It has 3 fixed channels (E, F, and G), and a fixed emergency channel (H- Guard, 121.5 MHz). The FR 24 is powered by the main battery.

3

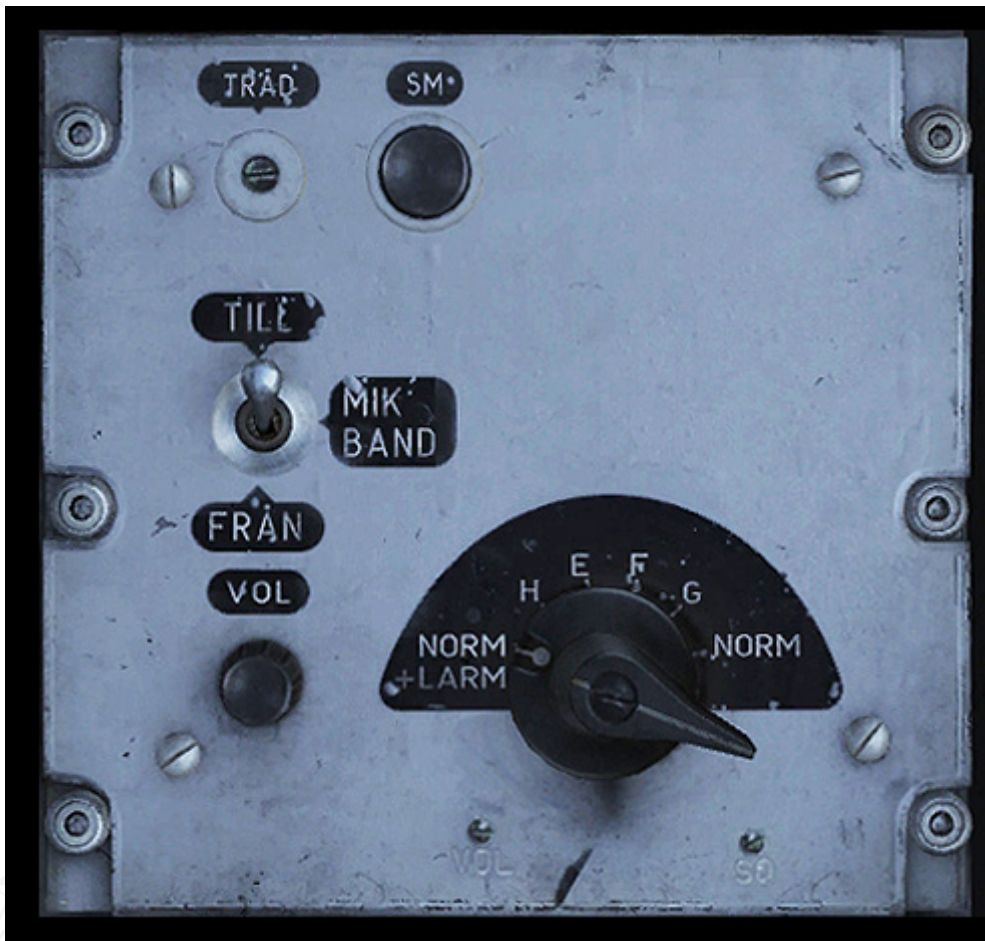

Figure 159. FR24 radio panel.

Mode selector

The functionalities of both radios are controlled by the FR24 mode selector.

NORM + LARM: Normal FR22 main radio functionality, with monitoring of the guard frequency 121.5 MHz.

H: Guard frequency using the FR24 backup radio.

E, F, G: Preset channels using the FR24 backup radio.

NORM: Normal FR22 main radio functionality.

Radio controls overview

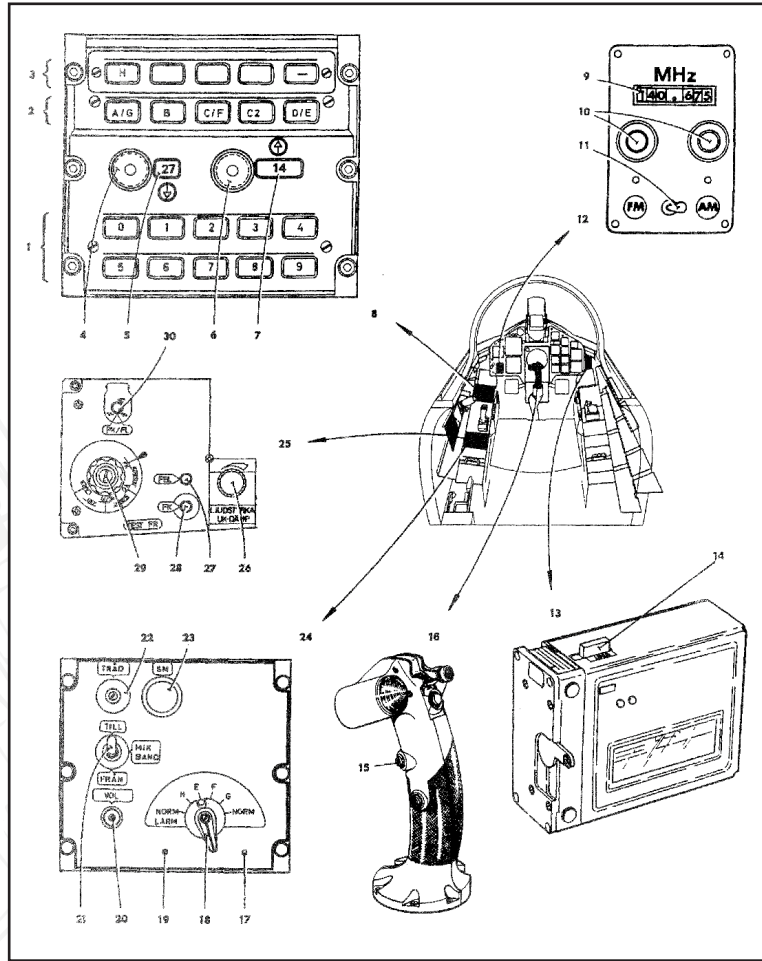

Figure 160. Radio controls overview

- | | | |
|----------------------------------|--|--|
| 1. Buttons, group selector. | 13. Recording unit FB-7 (no function). | tercom pushbutton (TRÅD). |
| 2. Buttons, base selector. | 14. FB-7 start button (no function). | 23. FR 24 transmit button. |
| 3. Button, special selector. | 15. FR22 transmit button | 24. FR 24 panel. |
| 4. Dial, group selector. | 16. Control stick | 25. Radio test panel. |
| 5. Group indicator. | 17. Trim screw (no function). | 26. Missile tone / RWR volume. |
| 6. Dial, base selector. | 18. FR 24 channel / mode selector. | 27. Fault indicator light (no function). |
| 7. Base indicator. | 19. Trim screw volume (no function). | 28. Function check (no function). |
| 8. FR 22 panel. | 20. Radio volume control | 29. Fault locating switch (no function). |
| 9. Indicator, frequency setting. | 21. Recording switch (no function). | 30. PK / FL switch (no function) |
| 10. Frequency dials. | 22. Ground crew in- | |
| 11. FM / AM switch. | | |
| 12. Frequency panel. | | |

Electrical system

Battery

The battery fitted to the aircraft is a 24 V Nickel-Cadmium battery with capacity of about 37 Ampere-hours. Heating for the battery is automatic and requires no input of the pilot.

The battery is switched on in the apparatus bay on the right side of the aircraft and is operated by the ground crew when preparing the aircraft. Therefore, the pilot does not need to operate the battery and it can be considered to be switched on at all times.

The aircraft can be started on the battery about three times before running out of power.

Main generator

The main power source is the main generator, which is connected to the engine and will provide AC power during the flight. Additionally, there are two parallel rectifiers that will provide DC power from the generator.

Backup generator (ram air turbine)

The backup generator is in the form of a mechanically controlled and hydraulically deployed ram air turbine mounted on the left side of the fuselage.

The turbine is effective between airspeeds of 300 – 700 km/h. Speeds over 700 km/h may lead to damage of the RAT, and at speeds below 290 km/h no voltage is being generated.

The RAT extends automatically when the nose wheel is depressed, and is retracted automatically on landing gear retraction, but is not connected as a power source unless required.

On loss of power from the generator due to a failure, the RAT is automatically extended. The RAT can be manually extended with the RESERVSTRÖM (Backup power) switch.



Figure 161. Ram air turbine.

Ground power

The aircraft can be connected to a ground power unit that will provide both AC and DC power for the aircraft systems as well as compressed air for cooling electronics and other functions.

Use of the ground power allows the aircraft systems to be powered so tests, pre-flight checks, data input and flight planning can be done without the engine running.

The ground power is toggled via the radio menu. The ground intercom button (TRÅD) can be pressed to access the communications menu. Press ground crew > Ground power > Request to turn on the ground power.

Do not forget to disconnect the ground power before starting to taxi.

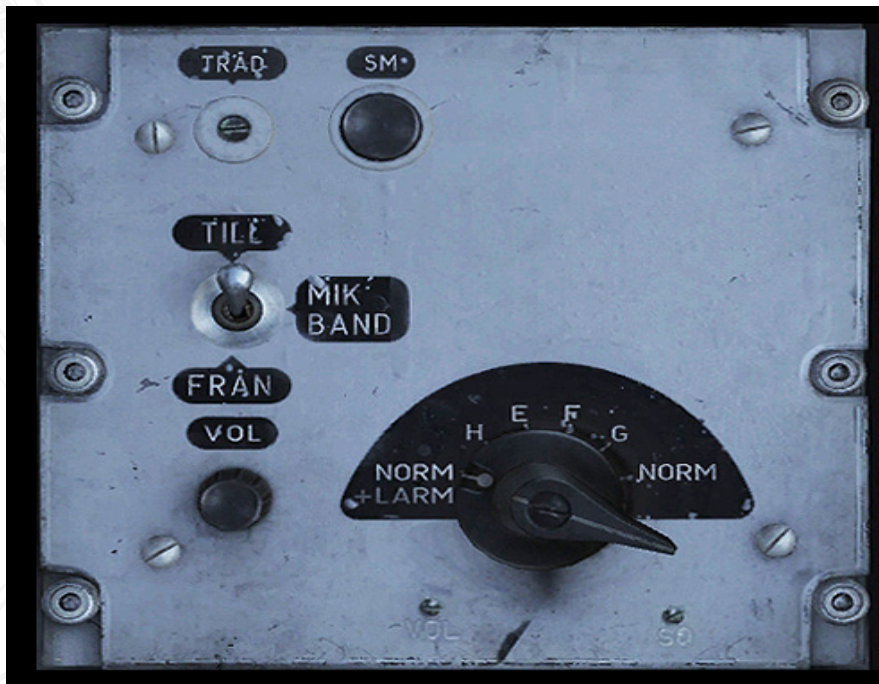

Figure 162. Ground intercom button (TRÅD) on the FR24 panel.

Circuit breakers

A number of push / pull circuit breakers are mounted on the right side panel. Pulling a circuit breaker will break this particular circuit.

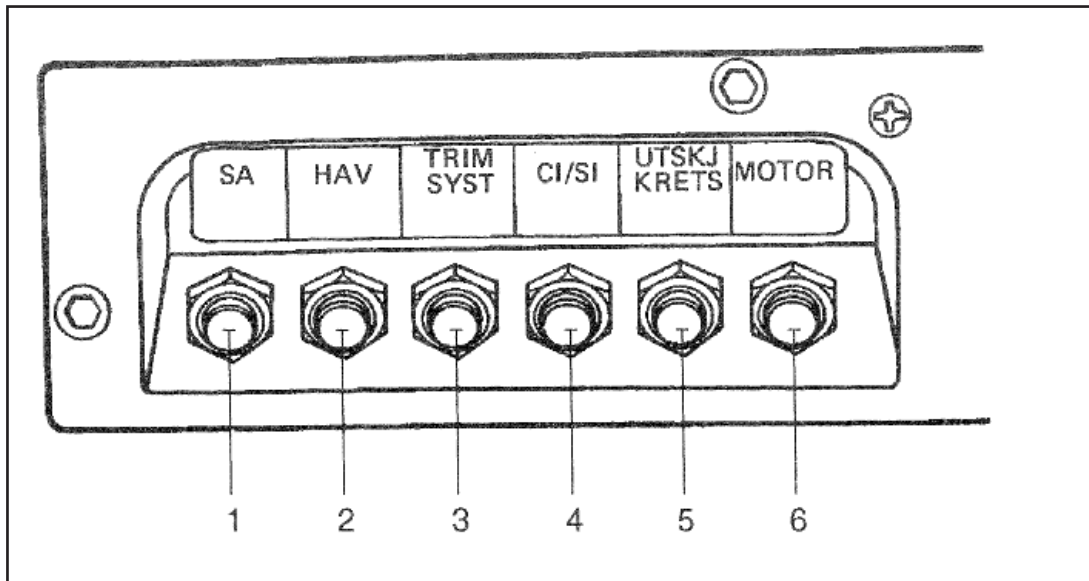

Figure 163. Circuit breakers.

1. Autopilot (SA), DC power supply for autopilot unit.
2. High Alpha Warning (HAV).
3. Trim systems (TRIM SYST), DC power for trim system.
4. CI/SI (Radar display / HUD) DC power supply for Central indicator / Heads up display.
5. Ejection circuits (UTSKJ KRETS).
6. Engine (MOTOR) Power supply for engine starter circuits.

Hydraulic system

Two hydraulic systems run in parallel to power the subsystems. These are simply denoted as system 1 and system 2. There are some overlap, in particular for the flight control surfaces.

The main hydraulic pumps are connected to the main gearbox which is driven by the engine turbine.

System 1

System 1 is powered by the main hydraulic pumps.

- Landing gear
- Nose wheel steering
- Airbrakes
- Thrust reverser
- Tertiary air hatch
- Fuel distributor
- Wing control surfaces
- Rudder
- Flaps
- Radar
- Pedal force feedback
- Wheel brakes

System 2

System 2 is divided into the main pump circuit and the reserve pump circuit.

The main pump is powered by the main engine through the main gearbox. The reserve circuit is powered by DC power from the battery.

- Landing gear (only main landing gear hatches and only backup gear extension)
- Wing control surfaces
- Rudder
- Flaps
- Pitch gearing
- Roll gearing
- Ram air turbine

Failure indication

Loss of pressure is indicated by the warning lights HYDR TR 1 for system 1, and HYDR TR 2 for system 2. Pressure loss may be due to a failure of the hydraulic pump or a leak in the system.

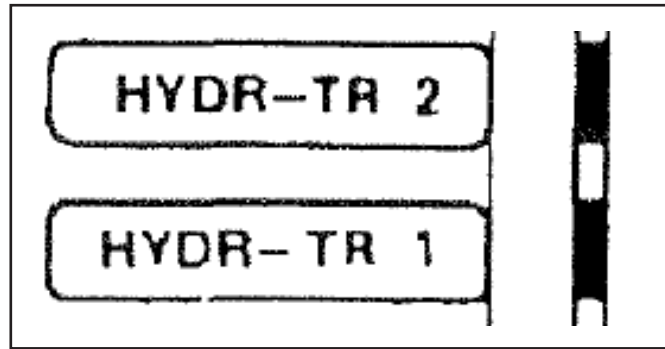

Figure 164. Hydraulic pressure fault indicator HYDR-TR 1 / 2. on left warning panel.

Failure cases Case 1

Loss of pressure in System 1

Indication: HYDR TR 1 lit and Master Caution active

Causes:

Main pump failure or leaks in the system.

Consequences:

- Control surfaces and flaps only receive pressure from system 2 and servo output reduced to about half.
- The landing gear can be extended through the main gear lever. The main landing gear hatches remain extended, and disrupt the radar-altimeter.
- Wheel brakes can make use of the remaining pressure stored in the accumulator tank. Pressure will drain with applied brakes.
- Nose wheel steering ceases to function.
- Airbrakes cannot be extended, however can be retracted through air resistance.
- Thrust reverser ceases to function.
- Tertiary air hatch cannot be operated. If the pressure drop occurs when the hatch is closed ($> M0.65$ and at least Zone 2 afterburner) the light **EJ REV** will be lit under airspeeds $< M0.65$.
- Fuel distributor stops. **BRÄ UPPF** warning if the fuel amount is over 30 %.
- The radar antenna ceases to function, the Central Indicator is turned off.
- The Autopilot is disconnected. **SPAK** is lit. The **HÅLL FUNK** is lit if pressure returns, if either the **ATT** or **HÖJD** autopilot modes are selected.

Case 2a

Main pump failure in System 2

Indication: HYDR TR 2 is lit, Master Caution on, the hydraulic pressure is lost and the reserve pump has engaged and is supplying pressure.

Consequences:

The secondary DC circuits are disconnected, which leads to the following:

- Radar ceases to function.
- HUD and Radar display are turned off.
- Armament and Countermeasures cannot be used.
- External lights, anti-collision lights and landing lights cease.
- RHM (Radar altimeter) ceases to function, indicator **RHM-FEL** is lit if altitude is $< 1200\text{m}$ and pitch and roll angle is greater than $< 40^\circ$.

After gear extension, all main power buses will be run from the main battery, which will last for about 15 minutes. All power from the inverters will now be dedicated to running the reserve hydraulic pump.

Case 2b

Failure of system 2 main pump and the reserve pump

Indication: HYDR TR 2 is lit and master caution on. After 6 seconds, RESERVEFF is lit, which indicates a failure of both the main pump and the reserve, or the system cannot maintain a high enough pressure.

Consequences:

- DC circuit disconnected as with case 2a.
- Control surfaces and flaps are only powered by system 1, which reduces servo-output to half.
- Pitch gearing is stuck in present mode, but will revert to low airspeed mode due to leaks. It can be set to landing mode via the switch. The warning **TIP-PVÄXEL** is lit when the switch is set to landing.
- Roll gearing will be stuck in high speed if airspeed is $> 350\text{km/h}$. If speed is equal or less than 350 km/h , it will drift to high speed mode due to leaks. If speed increases over 350 km/h the high speed mode will be set, and will remain in this position. There will be no **ROLLVÄXEL** warning.
- The reserve power unit (ram air turbine) will stay in present position. If the unit is retracted, it cannot be extended and no power can be produced in case of an electrical failure.

Combination of cases 1 and 2a

The hydraulic system is only powered by the reserve pump.

Indication: HYDR TR 1, HYDR TR 2 lit, Master Caution.

Causes:

Catastrophic engine failure, axle break in main gearbox, or gearbox failure.

Note: In case of engine flameout, the turbine will windmill, and therefore normal hydraulic pressure is maintained, assuming adequate airspeed.

If both main pumps are offline and the reserve pump alone powers system 2, large control surface input may lower the pressure momentarily, which causes the RESERVEFF caution to be lit.

Consequences:

Same as case 1, and case 2a.

Combination of case 1 and Case 2b,

Complete hydraulic failure. Both main pumps failed, reserve pump failed.

Causes.

Catastrophic system malfunction, massive leakage in system.

Consequences:

Complete loss of hydraulic pressure, aircraft cannot be manoeuvred.

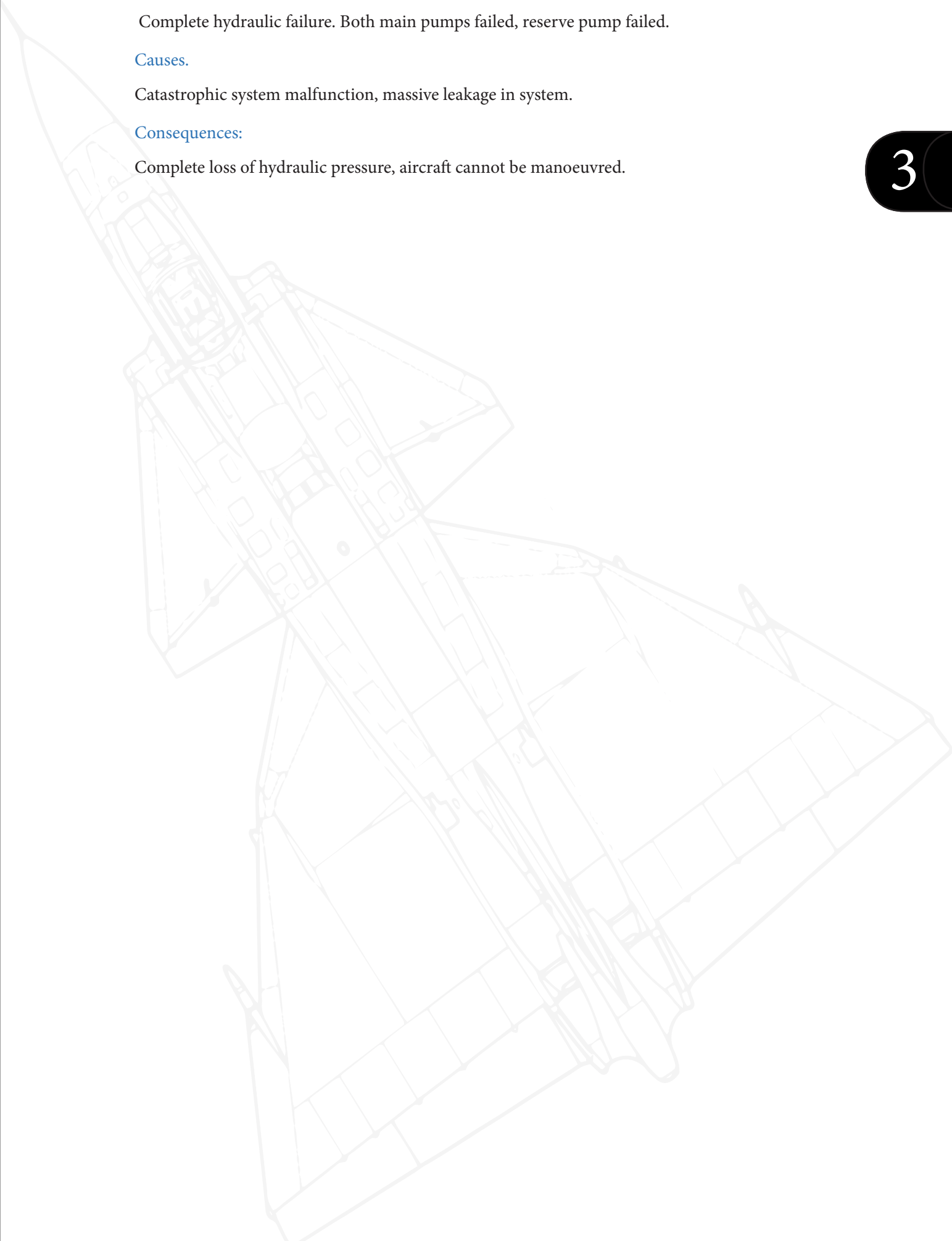

Lighting system (external/ internal)

External lights

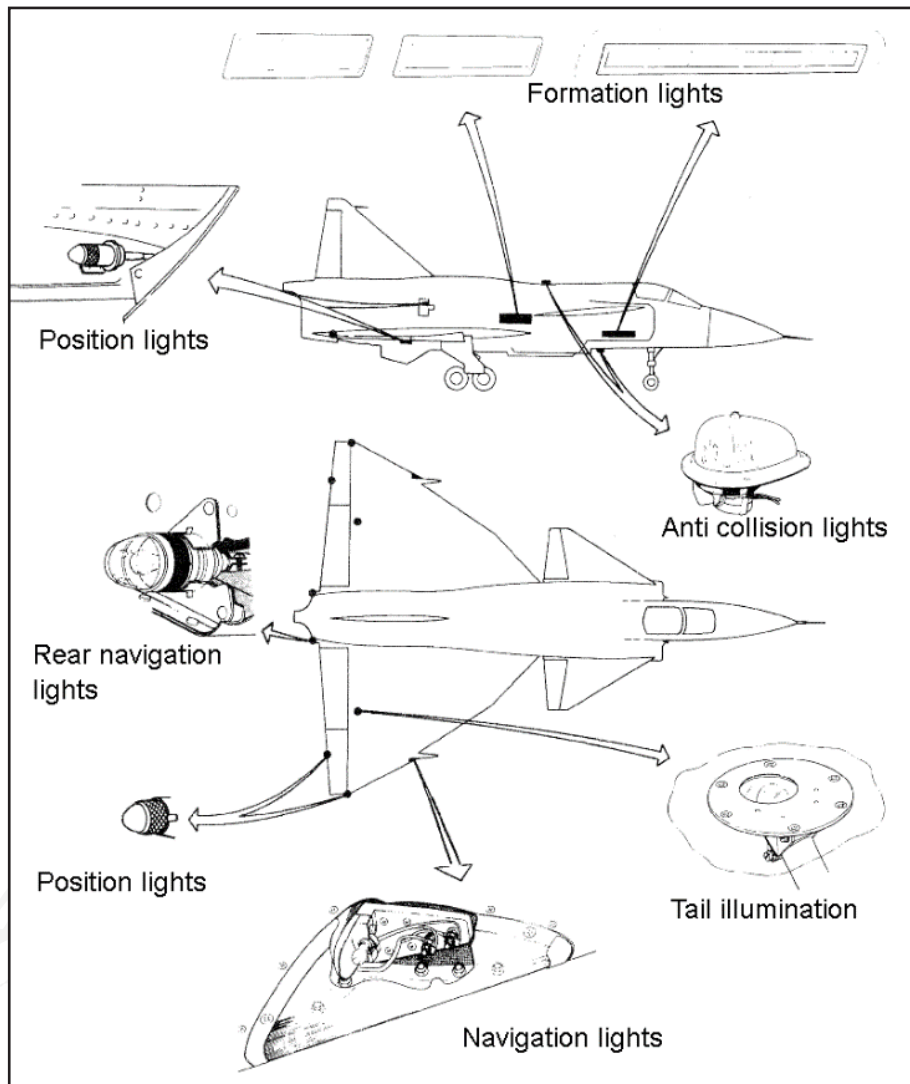

Figure 165. External illumination.

Navigation lights

The navigation lights are mounted on the leading edge of each wing (red / green) and two white lights are mounted on the ejector assembly.

The navigation lights are controlled by the switch LANTERNOR.

LANTERNOR switch position:

Neutral (middle) - Navigation lights off.

HEL: Navigation lights full strength.

HALV: Navigation lights half strength, and rear white navigation lights on full strength.

Position lights

Small white position lights are placed on the back of the wingtips and the outer elevon servos, as well as inside the airbrakes (as to indicate when opening airbrakes during formation flight at night). The position lights are controlled by the LEDLJUS switch, and their brightness by the formation / position lights brightness dial (FORMLJUS / LEDLJUS).

Formation lights

The formation lights are mounted on the side of the fuselage to aid in formation keeping at night. Additionally, a light is placed on top of either wing to illuminate the tail number on the vertical stabilizer.

Landing / taxi lights

The aircraft is fitted with three landing / taxi lights. A 50 W taxi light is mounted on the nose-gear strut. Two 250 W landing lights are placed on either side of the wheel well on the nose gear.

Landing lights are controlled by the switch STRÅLKAST.

Positions: FRÅN/ TAXI / TILL: OFF / TAXI / ON

Anti-collision lights

Two anti-collision beacon lights are mounted on the top and bottom on the fuselage.

The lights are controlled by the switch ANTIKOLLJUS.

Internal illumination

Instrument lights

The front panel illumination is controlled by the potentiometer INSTR BEL.

The emergency backup illumination is automatic on AC power loss. The lights can be toggled manually by the NÖDBEL switch.

Panel lights

The left and right side panel illumination is controlled by the potentiometer PANEL BEL.

Ambient illumination

The ambient lights provide illumination on the sides of the cockpit to provide better general illumination of the side panels.

The lights are controlled by the ALLMÄN BEL knob.

Illumination controls overview

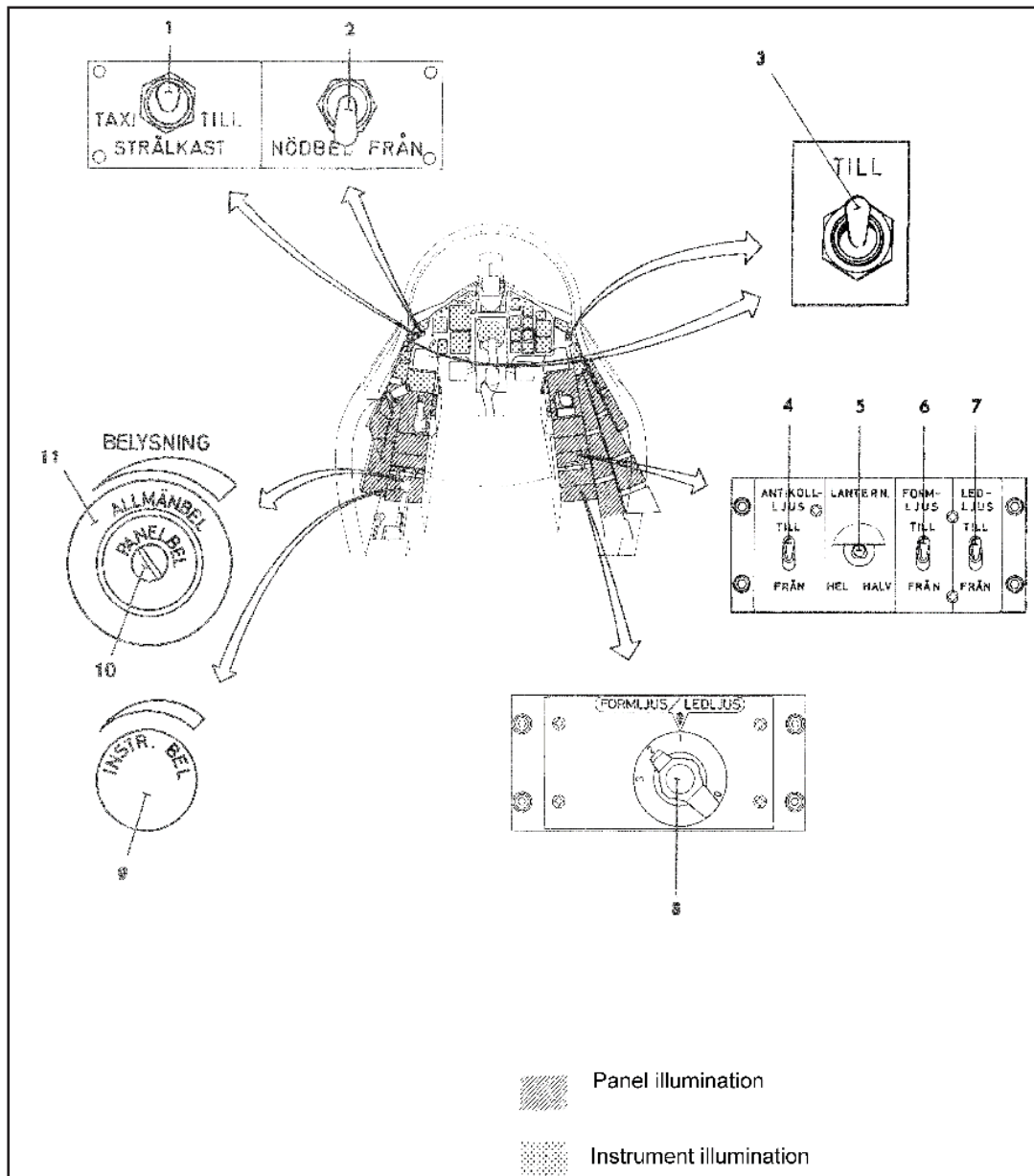

Figure 166. Illumination controls.

1. Landing / Taxi light switch (STRÅLKAST).
2. Emergency illumination switch (NÖDBEL).
3. Emergency placard illumination.
4. Anti-collision light (ANTIKOLL LJUS).
5. Navigation lights (LANTERNOR).
6. Formation lights (FORM-LJUS).
7. Position lights (LEDLJUS).
8. Formation / position light brightness.
9. Instrument illumination brightness.
10. Panel illumination brightness.
11. General illumination brightness.

Canopy, ejection seat, and oxygen

Canopy

The canopy is operated by the canopy actuator handle. The handle is pushed forward to close, and backward (aft) to open. The middle position is neutral. The cabin is sealed automatically if the canopy is closed and the engine is on.



Figure 167. Canopy control lever. In position neutral.

If the canopy is opened / not locked, the indicator light HUV o STOL is lit on the right indicator / warning table.



Figure 168. Canopy and ejection seat warning (HUV o STOL)

Canopy Jettison

In the event where the canopy has to be jettisoned, the canopy can be released via the Canopy emergency release button NÖDSKJUT HUV.



Figure 169. Canopy Jettison button (NÖDSKJUT HUV)

Ejection seat

The ejection seat is armed / disarmed by moving the large handle near the top of the seat. In the “forward” position the seat is secured and disarmed. Moving the handle into the side-ways stowed position will arm the seat.



Figure 170. Ejection seat arming lever. Left SAFE, Right (stowed) UNSAFE.

The ejection seat is activated by pulling the red ejection handles on the side on the seat. If the seat fails to eject, the backup handles (yellow) are then pulled.

Seat height can be raised / lowered by pressing the control switch mounted on the left side of the seat

If the seat is not armed and / or the canopy is not closed, the indicator light HUV o STOL is lit on the right indicator / warning table.

Oxygen

The oxygen system is integrated with the aircraft and an aircraft mounted oxygen bottle.

The remaining oxygen pressure is indicated on the oxygen pressure indicator on the right front side panel. A valve for the oxygen system is mounted next to the indicator dial, it opens and closes the oxygen flow to the pilot's mask.



Figure 171. Oxygen pressure indicator (kp/cm²) and oxygen valve ON (TILL)

4. WEAPONS OVERVIEW



AJS 37
V I G G E N

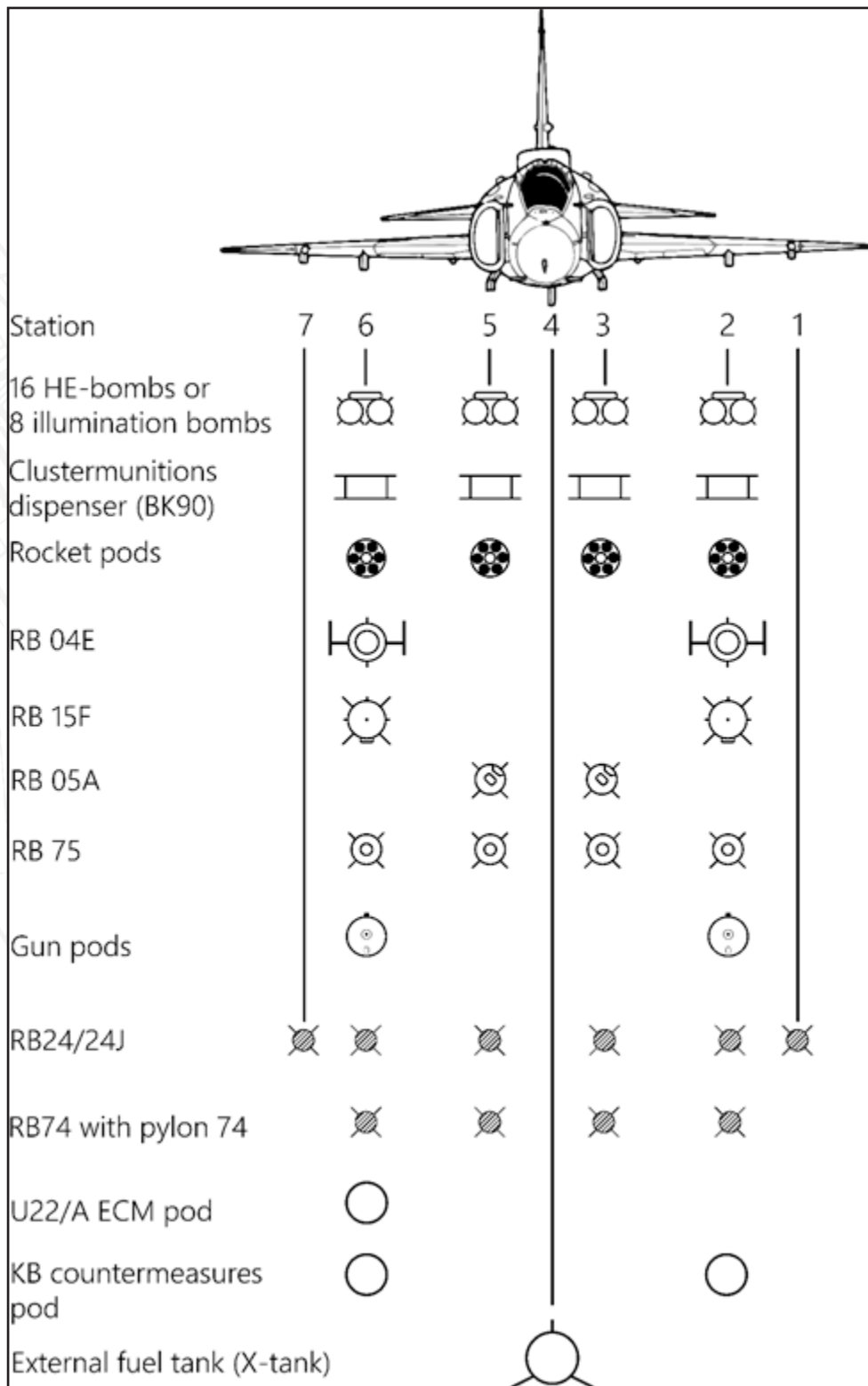

Figure 172. Armament type overview.

Weapon types

ARAK M/70B rockets

The AJS can mount up to four rocket pods with six 135 mm rockets in each. Once fired, the rockets will launch in a salvo, and will be emptied in 0.6 seconds. The pods can be loaded with rockets either with high-explosive or armour-piercing warheads. While types of pods can be mixed, they are usually only loaded for a specific target type.



Figure 173. ARAK M/70B rocket pod (HE rockets).

Specifications

Length: 3226 mm.

Diameter: 486 mm.

Weight: 387 kg.

Empty weight 104kg.

High explosive: SHU70 (SprängHUvud 70).

Total Length: 2105 mm.

Total Weight: 45.8kg.

Warhead explosive: 3.7 kg TNT.

Armour piercing: PSHU70 (PansarSprängHUvud 70).

Length: 2165 mm.

Total Weight: 44.6 kg.

Warhead explosive: 5.0 kg Hexotol (Comp B) shaped charge.

AKAN 30/55 gun pod

The gun pods consist of a 30 mm AKAN (Automat KANon) m/55 (ADEN) in gun pod with 150 rounds per gun (30/55 MINGR55 HE rounds.)

The pods can either be used in an air-to-air or an air-to-ground role. Casings and links remain in the pod after firing.



Figure 174. AKAN M/55 Gun pod.

Specifications.

Muzzle velocity: 790 m/s.

Projectile weight: 0.220 kg.

Rate of fire: 1300 rpm.

Barrel length: 1.08 m.

Weight Gun pod including ammunition: 364 kg.

Weight unloaded: 290 kg.

Weight after firing: 324 kg (Links and casings left in pod).

Sprängbomb 120kg M/71 General purpose bombs

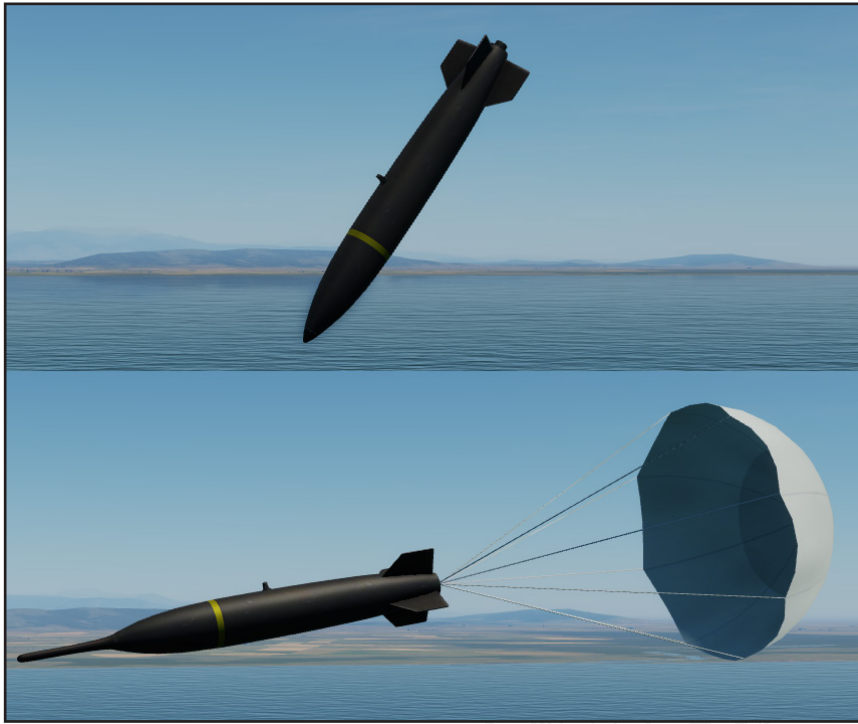

Figure 175. SB71 Low drag and high-drag versions.

The only bomb type available for the AJS-37 is the 120 kg SB-71 bomb. The bombs are mounted in pylons of 4 bombs. The bombs exist in low-drag and high-drag (with a drag chute) versions. The bombs can be fitted with either an instantaneous fuse (ÖHKSAR) or an airburst fuse (ZONAR).

Length: ZONAR & drag chute: 1875mm.

Length: ÖHKSAR & ZONRÖR: 1582 mm.

Diameter: 214 mm.

Fins ingspan: 368 mm.

Weight: 121kg each.

M/71 pylon weight: 125kg.

Explosive filler: 30 kg Hexotol (Composition B).

Lysbomb 80kg M/71 Illumination bomb

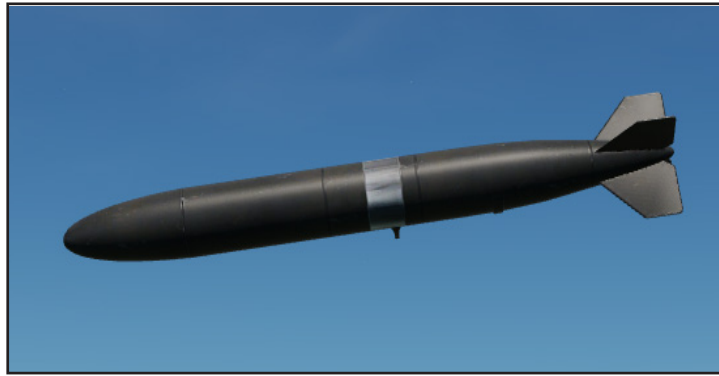

Figure 176. LYSBOMB M/71 Illumination bomb.

Total length: 1970 mm.

Diameter: 201 mm.

Total weight: 80 kg.

M/71 pylon (same as M/71 bombs): 125 kg.

Illumination flare weight: 25kg.

Fins (Straight) wingspan: 408 mm.

Illumination time: around 170 s.

Descent speed (average): 5 m/s.

Luminosity: 3.000.000 Candela.

The Illumination bombs are used for the purpose of battlefield illumination. The bomb is released and will deploy a parachute flare illuminating the target. The aircraft computer can be set to calculate the release point offset of the target, either on top of it or left or right with a set distance.

RB-04E Anti-ship Missile



Figure 177. RB-04E Anti-ship missile.

The RB 04E is a development of the missile previously used on the A32 “Lansen” during the 1960’s. The missile will on release descend to a sea skimming altitude (10m). Two missiles can be carried on the inner wing pylons.

The radar seeker of the missile will automatically lock on to a target in front of it. The seeker has a range of about 8 km and an angle of $\pm 28^\circ$. The seeker can however be programmed to lock on grouped ships, however this requires the maximum spread of the ships to be no more than 2700 m.

Length: 4.45 m.

Diameter: 0.5 m.

Wingspan: 1.9 m.

Weight: 625 kg.

Including launcher 661 kg.

Solid-fuel rocket engine: KR 16D2.

Thrust: 1913 N, for 65, 6 s.

Range: about 32 km.

Warhead: 200 kg High-explosive.

Release altitude: 50-425 m ASL.

Speed: High subsonic.

RB-15F Anti-ship missile



Figure 178. RB-15 Anti-ship missile.

The RB-15F is a development of the RB 04E. The missile is jet-propelled, which yields a significantly longer range. The missile is substantially more advanced with in-cockpit flight planning linked to the aircraft navigation system and sophisticated target selection and seeker options. The missile can be programmed to fly a set route based either by inputting coordinates or setting those coordinates by use of the radar. The missile was originally intended for the JAS 39 Gripen replacing the Viggen, however during the AJS upgrade, the increased computer capabilities allowed for the implementation of the RB 15.

Length: 4.33 m.

Diameter: 0.5 m.

Wingspan: 1.4 m.

Weight: 565 kg.

With launcher: 605 kg.

Thrust: TRI 60-2 Turbojet: 3.73 kN.

Range: 70 km.

Warhead: 200 kg High-Explosive.

Release altitude 50-2000 m.

Airspeed: Subsonic, around Mach 0.9

RB-05A air to ground / air to air missile



Figure 179. RB-05A air-to-ground / air-to-air missile.

The RB-05A is a radio-controlled missile designed for the AJ37 Viggen. The missile can be used against land and sea targets, but can also be used in an air-to-air role with a radar proximity fuse.

On firing, the pilot uses the separate RB-05 control unit in the cockpit to guide the missile visually onto the target. A large flare is fitted on the back of the missile to aid in aiming. The liquid-rocket engine is designed to be as smokeless as possible in order to preserve the pilot's view of the target.

Weight: 305 kg.

With launcher 341 kg.

Length: 3.6 m.

Diameter 0.3 m.

Warhead 160 kg HE.

Engine: VR35 liquid-fuel rocket engine. Inhibited red fuming nitric acid (IRFNA) and Hydyne fuel.

Range: 9+ km.

Airspeed: Mach 1.3 – 1.5.

Rb-75 (AGM65A) Air to ground missile



Figure 180. RB-75A

The AGM-65 “Maverick” is an electro-optical television guided, stand-off missile designed for engaging armour, fixed units and fortified targets. The seeker of the missile enables a “fire and forget” use.

The missile is aimed by using the collimated sight (EP-13), which is mounted right of the Head-up Display.

Length: 2.49 m.

Wingspan: 0.72 m.

Diameter: 0.30 m.

Weight: 210 kg.

With launcher 258 kg.

Warhead: 57 kg shaped-charge.

Range: Target size dependant. 22km max.

BK-90 (Bombkapsel 90) Cluster munitions dispenser “Mjölner (Mjolnir)”

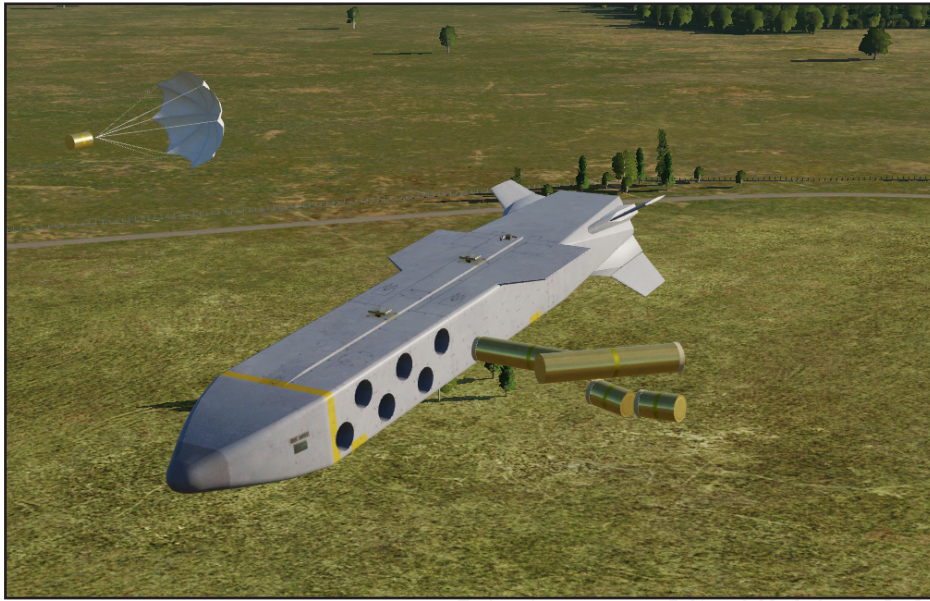

Figure 181. Bombkapsel 90 Cluster munitions dispenser "Mjolnir"

The BK 90 is a stand-off gliding cluster-munitions dispenser. The key difference to other cluster munitions types is that the BK 90 does not require the aircraft to overfly the target, but can be delivered about 10 km away, even with the aircraft not directly facing the target. The weapon will on release fly to the target area set by the internal inertial navigation system fed coordinates from the aircraft navigation system and will eject the submunitions over the target in a set pattern.

The aircraft can carry up to four dispenser pods mounted on the fuselage and inner wing pylons. However, the Swedish Air Force only flew with two mounted on the inner wing pylons due to the adverse aerodynamic effects the weapons had on the aircraft.

Length: 3.5 m.

Weight: 605 kg \pm 12 kg.

Width: 1 m.

The dispenser has 24 launch tubes which are filled with a selection of the following submunitions;

MUSJAS (MJ) 1: High-explosive air-burst munition against soft-targets. 3 per tube. Maximum of 72 total.

Weight: 3.7 kg.

MUSJAS (MJ) 2: Armour piercing munition with explosively formed projectiles. 1 per tube. Maximum of 24 total.

Weight: 16.9 kg.

RB-24J / RB74 (AIM-9P/L) Sidewinder

Although the AJS-37 is primarily an attack aircraft, it can carry Sidewinder missiles for self-defence and for limited offensive fighter roles. The missiles can be carried on either the fuselage, inner wing, or outer wing pylons. The outer wing pylons only allows the use of the RB 24J.

RB 24J (AIM-9P) Sidewinder



Figure 182. RB24J

Rear-aspect infrared seeker.

Length: 3 m.

Weight: 81 kg.

With launcher: 119 kg.

Warhead: 4.8 kg.

RB74 (AIM-9L) Sidewinder



Figure 183. RB74

All-aspect infrared seeker.

Length 2.9 m.

Weight: 85.4 kg.

With launcher: 123 kg.

Warhead: 9.4 kg.

The RB 24B (AIM-9B / GAR-8) was also usable on the AJS-37 but removed from service by the 1990's.

KB countermeasures dispenser pod

Combined chaff / flare dispenser pod. The pod can only be mounted on the inner wing pylons.

Weight: 316- 296 kg, depending on countermeasures loaded.



Figure 184. KB

U/22 ECM pod

The U/22 is an electronic jammer pod. Can be mounted on the right inner wing pylon.



Figure 185. U/22 Pod

Weight: 248 kg.

U/22A ECM pod

The U/22A is a combined electronic jammer and receiver pod, enhancing the on-board APP-27 RWR system with further signals analysis and recording capabilities. Can be mounted on the right inner wing pylon.

Weight: 248 kg.

4

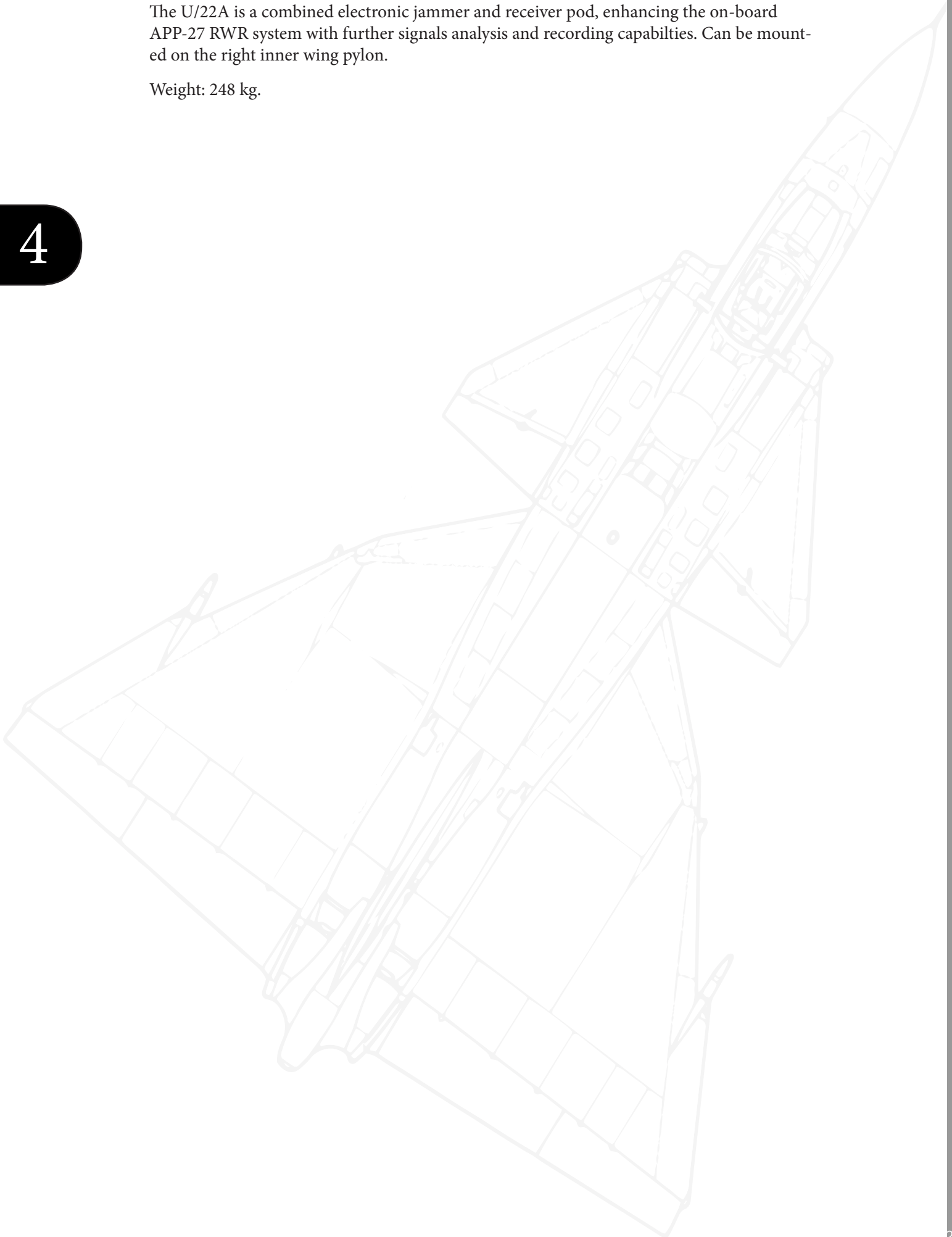

5. PROCEDURES



AJS 37
V I G G E N

Start-up procedure

Normal start-up (with ground power) checklist

Before engine start- up with ground power on.

If starting without Ground Power on, items marked with * must be performed after engine start as they cannot be performed without AC power.**

1. Ejection seat	SAFE. Lever is position forward.
2. Trigger safety	SAFE.
3. Parking brake	ON Depress brakes and pull handle.
4. Data Cartridge	Insert into slot.
5. Main power (HUVUDSTRÖM)	ON (TILL)
	This turns on the main power. DC power provided by the battery if ground power is off, and AC power if Ground power unit is enabled.
6. Low pressure fuel valve (LT-kran)	ON (TILL) Low Pressure fuel valve.
7. Master Caution	Cancel alarm.
8. Cockpit illumination	Desired setting.
9. Master Mode selector	Master Mode BER.
10. Landing gear lever	OUT. Confirm that landing gear lever is down to prevent retraction on hydraulic pressure.
11. Autothrottle lever OFF	Confirm that Autothrottle (AFK) is off.
12. Throttle	Ground idle (MTG). Click the throttle catch (on front left). Opens up the High pressure fuel valve.
13. Landing light (STRÅLKAST)	OFF (middle position).
14. Emergency Lights (NÖDBEL)	OFF (FRÅN)
15. Check backup instrument illumination ***	See checklist below.
16. Check warning panel lights	Press and hold WARNING PANEL TEST (KONTR LAMPTABLÅ.)
	a. Press and checkH all indicator lights on the warning panel. Release and confirm that lights marked with white are lit. Without Ground power, ELFEL, RHM FEL and CK will be lit. X-TANK BRÅ will not be lit if the drop tank is empty.
	b. If Pitch gearing warning (TIP-PVÅXEL) is lit, engine start is still allowed. This should disappear during engine start.
17. ROLL TRIM ***	Check and centre.
18. Generator	ON (TILL)
19. Autopilot yaw correction (RENFlyGN-ING)	Set to 0. Fine-tunes yaw input from autopilot.

20. Yaw trim (SID TRIM) ***	Check and centre.
21. FR 24 radio	NORMAL + GUARD (NORM+LARM). Enables normal radio function (FR 22) and backup radio to monitor the guard (emergency) frequency.
22. RADAR illumination strength	Middle position.
23. MIK BANK (Flight recorder)	Set to desired position.
24. Radar panel	Normal settings (see radar settings below).
25. Radar altimeter setting LAND / SJÖ (Land / Sea)	Desired position. Sets the radar altimeter for either land or sea.
26. Thrust Reverser	OFF. Confirm that thrust reverser selector handle is retracted.
27. Attitude Director Indicator FLI 37 (ADI) ***	Check proper alignment, Fast Erect if needed.
28. FR 22 Radio	Set correct base and channel, FM/ AM selector Desired position (normally AM)
29. HUD reflector glass	Landing setting (lower). Set the reflector glass to the lower setting to allow display of take-off and landing modes.
30. HUD slave switch SLAV-SI	OFF (F).
31. Altitude source selector HÖJD CI SI	LD, sets altitude information in HUD, and radar display to use barometric altitude.
32. Backup Artificial Horizon ***	Fast erect. Pull out knob on instrument to cage and erect.
33. Backup altimeter	Reset and set altimeter to maximum of 3 hPa difference from QFE.
34. Backup Course indicator***	Fast erect by pressing the button instrument, indicator light turns off when completed.
35. Engine pressure ratio	Check, should be around 1.0.
36. Fuel indicator ***	Check, should deviate a maximum of either $\pm 5\%$ from 106 or 131% (full fuel load without or with external tank)
37. KB countermeasures pod and APP-27 Radar Warning Receiver	Desired positions.
38. Exterior lighting	Desired setting.
39. IFF system	Desired setting. Normally ON (TILL).
40. Course Correction KURSKORR	Check and set local magnetic declination.
41. Windshield / Canopy defrost (VARMLUFTSPOLNING FRONTRUTA)	OFF.
42. TILS selector	Mode A (Automatic).
43. Radar Altimeter	ON (TILL).
44. Weapon Selector	Desired position.

5

45. Weapon Release mode selector	Desired position.
46. Weapon Target mode selector	Desired position.
47. Circuit breakers (right CB panel)	Confirmed ON (pushed in).
48. Data Input ***	Load data cartridge and input other necessary data. <i>Please review the data input notes below and the navigation data section further ahead..</i>
49. Oxygen	Check pressure and open flow valve.

Developers Note:

At minimum, always make sure the starting airbase is entered if not using the data cartridge.

The Mission Editor will at a minimum assign an LS starting airbase that the aircraft was assigned to and a B1 waypoint if no data cartridge is loaded or other data otherwise entered.

Note:

To make sure initial course is set, the coordinates for the start base with runway heading should always be inputted if not set via reference number.

50. Indicator System check. *** Press KONTROLL Button (right side panel)
» High alpha Warning- two short bursts. Stick vibrates.
» Warning lights BRAND (Fire warning) lit
» Lights LANDSTÄLL (Landing gear warning) <u>not</u> lit.
» Altitude warning light lit with a solid light.
» Indicated fuel 29 ± 3 % and indicator returns to previous setting.
» Data indicator panel shows 1 and current CK-program number.
» FK-light is on (green).

51. Canopy	Close and check locked. May be closed earlier if needed.
------------	--

START SWITCH	ON (TILL) and hold for 2 seconds (switch will be held in place automatically during the duration of the engine start cycle)
--------------	---

Engine Start

Check:

- » Indicator light STARTSYS is lit within 5 seconds (if not START SWITCH OFF).
- » Maximum EGT (exhaust gas temperature) 400° C is not exceeded.
- » If exceeded. Throttle to OFF, START SWITCH to OFF. Engine is likely faulty.
- » Checks during ground idle.
- » RPM: 55-65 %.
- » Pressure ratio: around 1.0.
- » Nozzle indicator: Fully open.
- » Maximum Exhaust Gas Temperature (EGT): 350 °C.
- » Indicator lights: OFF;
- » OLJETRYCK (oil pressure may be lit maximum of 60 seconds) X-TANK BRÄ (Drop tank fuel).
- » SPAK: Automatically turned ON. Check.
- » If risk for engine icing. Turn engine de-ice (AVISNING MOTOR) ON (TILL).

Note:

Exhaust gas temperature (EGT) should increase within 30 seconds.

Further start-up attempts may not be made if (due to safety concerns):

Failed start-up due to exceeded EGT.

RPM has increased over 65% without pilot input (possible danger of runaway engine).

A maximum of three engine start-up attempts is allowed. At least a minute should elapse between each attempt is started.

When the STARTER SWITCH is set to ON (TILL), until the indicator light START-SYST is turned off, the Master Caution system is inhibited.

5

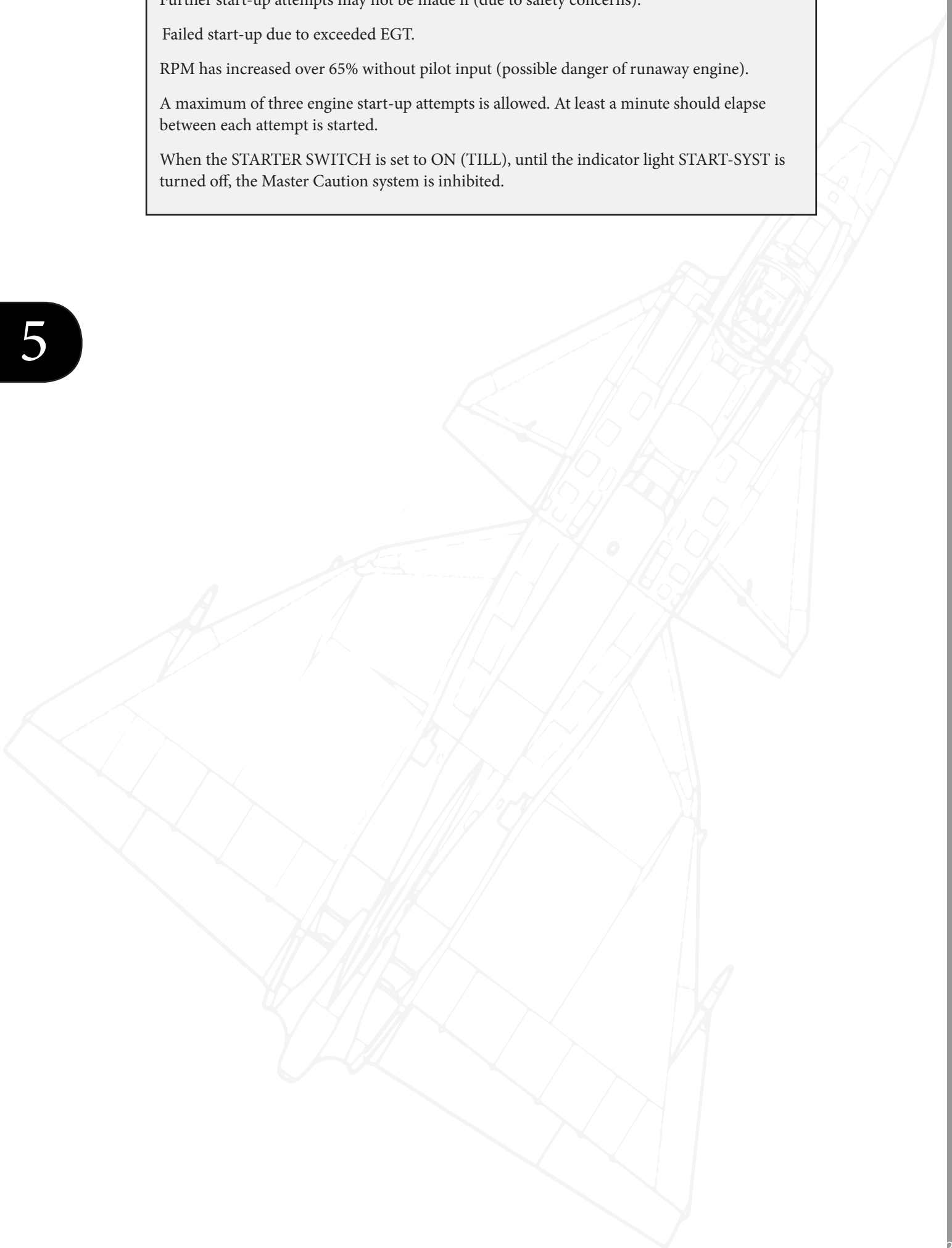

Start-up without ground power

After Engine start without Ground Power.

If engine start-up has been done without ground power, run through the checklist below;
(Due to AC power only available after engine start)

1. Backup instrument illumination	Check.
2. ROLL TRIM	Check.
3. Yaw trim (SID TRIM)	Centre.
4. Attitude Director Indicator FLI 37	Check proper alignment, Fast Erect if needed.
5. Backup Artificial Horizon	Fast erect. Pull out knob on instrument to cage and erect. Press to knob to uncage.
6. Backup Course indicator	Fast erect by pressing the button in-strument, indicator light turns off when completed.
7. Fuel indicator	Check, should deviate a maximum of $\pm 5\%$ from 106 or 131% (without or with drop tank).
8. Data Input	Load data cartridge and / or input other necessary data.

IMPORTANT: At minimum, always input or confirm the correct the start air-field.

Developers note: In DCS, the system will automatically detect the start airfield and load it into memory

Note:

To make sure initial course is set, the coordinates for the start base as well at the runway heading should always be inputted if not set via reference number.

9. Indicator System: Check. Press KONTROLL Button (right side panel):
» High alpha Warning- two short bursts. Stick vibrates.
» Warning lights BRAND (Fire warning) lit
» Lights LANDSTÄLL (Landing gear warning) <u>not</u> lit.
» Altitude warning light lit with a solid light.
» Indicated fuel $29 \pm 3\%$ and indicator returns to previous setting.
» Data indicator panel shows 1 and current CK-program number.
» FK-light is on (green).

After engine start checklist

5

1. Control surfaces	Free and full deflection possible.
2. Pitch trim	Check. Position 0 with A/C without drop tank or drop tank empty. -3 (nose up) if A/C with external tank mounted.
3. Airbrakes	Check.
4. Brake Pressure	Depress brakes and check pressure 200-270 kp/cm ² .
5. Ejection seat	UNSAFE (pull lever above the head to sideways stowed position),
6. Altimeter	Reset and check maximum deviation of 2 hPa from QFE,
7. Master Caution, Warning lights	Check. (X-TANK BRÅ disappears first after 70% RPM),
8. Autopilot	Emergency disconnect, SPAK ON.
9. Wheel Chocks	Remove.
10. Landing light	Taxi.

Dry start (Ventilation)

Used in event of a flooded engine after a failed start attempt. Used to purge the engine.

1. Igniter (TÄNDSTIFT)	OFF
2. Throttle	OFF (Fully rear)
3. LT-KRAN (Low pressure Fuel valve)	OFF. Confirm light off.
4. START SWITCH	ON, hold for 2 seconds.
5. After 40 seconds	
6. START SWITCH	OFF

Radar initial setup

Radar mode selector	Position A0
AS- mode	1
Passive search (PASSIV SPANING)	OFF (FRÅN)
LIN / LOG	LOG
Antenna elevation	Middle position (snap)

Takeoff & Landing

Taxi to runway

Full deflection of rudder gives a nose wheel rotation of about 30°. Turning radius can be reduced by using differential braking.

On increasing throttle above ground idle, check that ejector nozzle is closed.

Fuel consumption on the ground is about 0.3% per minute.

The engine gives a relatively high amount of thrust on idle, which is why taxiing on slippery and even on dry surfaces should be done carefully.

Thrust reversal may be used to reduce speed during taxiing.

In confined areas, thrust reversal may be used to reverse the aircraft.

Check that the area is clear behind the aircraft before reversing.

Do not reverse if the surface consists of a large amount of particles, such as sand or stone. Use as little thrust as possible.

CAUTION: when reversing, do not apply the brakes until the aircraft has come to a complete stop, as this may cause the aircraft to pivot backwards and lead to a tailstrike.

Take-off procedure

Before take-off

1.	Align the aircraft with the runway	
2.	Main course, Backup course, Backup artificial horizon, and Altimeter	Check.
3.	Master Mode selector	NAV (At the earliest 2 minutes before throttle up, to avoid problems with the navigation system)
4.	Manual course setting	If needed. Press Reference button (on stick) after carefully aligning with the runway heading.
5.	SPAK	ON, Check light on.
6.	Master Caution, Warning lights	Check. (X-TANK BRÄ disappears first after 70% RPM)
7.	HUD symbology	Check that information is correct.
8.	Landing light	ON (LANDNING)

Note.

The Radar and Central Indicator (CI) will first function 30 seconds after Master Mode Selector is set to NAV, and 180 s after the generator is on. (Due to software initialisation)

Manual initial course setting

If runway is slippery and there are heavy crosswinds, the manual course setting should be used:

1.	Master Mode selector	NAV.
2.	HUD reflector glass	Inflight mode (upper).
3.	Carefully align aircraft with runway heading.	
4.	Press the reference button (on stick).	
5.	HUD reflector glass	Lower to Take-off / landing mode
To reset an existing manual initial course setting, the Master Mode selector needs to be cycled (NAV – BER – NAV). Does also apply if the pilot desires an automatic setting of the initial course.		

Take off methods.

By using the HUD

1. Apply brakes
 2. Advance throttle to maximum power without afterburner.
 - a. Check EGT (max 590°C + outside ambient temperature)
 3. Release brakes, steer with pedals
 4. If needed, ignite afterburner.
- Check:**
- a. Zone indicator = desired afterburner zone.
 - b. Exhaust nozzle indicator = desired zone achieved.
 - c. Pressure ratio (EPR):

Zone 2

» < +15°C	> 1.9
» > +15°C	> 1.8

Zone 3 = Maximum power
5. Check airspeed indicator and Time / distance line
 6. Rotate with the flight path vector when the time / distance line reaches the markers.
 - » Set flight path vector to;
 - a. The horizon line when not using the after burner
 - b. To about the height of the outer pillars (about 3° above the horizon) when using the afterburner.
 7. Check the increased airspeed on the airspeed indicator.
 8. Retract the landing gear when airborne.
- Note the risk of a decrease in lift as the flaps retract when retracting the landing gear.**
9. Climb with selected attitude until the flight path vector appears. The HUD should switch modes automatically between the take-off symbology and the normal navigation mode.
 10. Elevate HUD reflector glass to inflight mode to display HUD symbology when at lower angles of attack.

By using the Flight Attitude Indicator

1. 1-4 same as when using the HUD method.
5. Rotate
 - At 280 km/h to a 10° climb attitude when using maximum power without afterburner
 - At 250 km/h to a 13° climb attitude when using afterburner
6. Retract the landing gear when airborne.
7. Elevate HUD reflector glass to inflight mode to display HUD symbology when at lower angles of attack.

Note: There is a risk of a slight decrease in lift as the flaps retract when retracting the landing gear.

Take-off on short runways.

To achieve the shortest possible take-off distance, Zone 3 afterburner should be used.

Note: With Zone 3 afterburner, the aircraft accelerates very quickly and may result in reaching maximum allowed airspeed with extended landing gear before it has fully retracted.

Visual approach

Flight should be planned with at least 10% remaining fuel on touchdown. A normal landing pattern uses about 8% fuel.

1. Reduce airspeed to V_i 550 km/h during approach.
2. Check the backup attitude indicator. Fast erect if needed.
3. Extend the landing gear. Check landing gear indicator (3 green fields)
4. Landing light ON (LANDNING)
5. Preselect thrust reversal if desired. (*Please reference the "Thrust reverser use" section on the next pages ahead*)
6. Check brake pressure (200- 270 kp/cm²).
7. Set HUD reflector to lower setting (landing mode). Set master mode LANDN PAR/OPT.
8. Do not fly below an airspeed corresponding to $12^\circ \alpha$ (AoA).
9. Turn final during descent with a minimum airspeed corresponding to $12^\circ \alpha$ (AoA).
10. Aim for a 3° angle of descent and reduce airspeed to correspond to $12^\circ \alpha$ (AoA). The line in the HUD during LANDN P/O corresponds to 2.86° .
11. Place the descent line on the runway threshold and centre the sight dot on the centre-line, steer the flight path indicator onto the line. Maintain attitude. Strive for a touchdown at about 100-200 metres in on the runway.
12. At 15 metres altitude above the runway (30 if not using the radar altimeter), the HUD will change to the descent rate mode. The previous 2.86° line represents the maximum vertical velocity (2.96 m/s).
13. Thrust reversal (if preselected) will activate once nose wheel is depressed.

Braking

There are two main styles of braking during landing.

Aerobraking

- After touchdown gently pull back the stick to AoA (α) 16°.
- Lower the nose at around 160 km/h.
- Steer with the rudder.
- Apply brakes evenly.
- If needed, engage thrust reversal.

Normal braking (with or without thrust reversal)

- Lower nose immediately after touch-down.
- Engage thrust reversal if needed.
- Apply wheel brakes evenly.
- Steer with the rudder.

After landing

1. Master Mode selector	BER
2. Taxi / Landing lights	Desired position

Note: If the master mode selector is not set to mode BER, the pilot is reminded to do so by the lit altitude warning light.

Shutdown procedure

1. Ejection seat	SAFE
2. AFK (Autothrottle) lever	OFF (Upper)
3. Generator	OFF
4. Avionics and other systems (RWR, IFF, External illumination, etc.)	OFF
5. Oxygen	OFF
6. Low pressure fuel valve (LT-KRAN)	OFF
7. Canopy	Open
8. Main Power	OFF

Thrust reverser use

The aircraft can, by using thrust reversal and heavy use of wheel brakes, achieve very short landing distances. Thrust reversal may also be used to reverse the aircraft while taxiing.

Thrust reversal is initiated by pulling the reverser handle. The indicator light will be lit when the reverser circuits are active. If the handle is pulled while the aircraft is airborne, it will preselect thrust reversal. The reverser flaps will close when the main landing gear is depressed but will open again until the nose-gear is depressed. Afterburner may not be used during reversal, as this would cause extensive damage to the aircraft.

IMPORTANT: During thrust reversal an amount of stick back pressure is necessary to lessen the force on the nose-gear. The more thrust is applied, the more stick pressure is necessary.

5

Use of thrust reversal with a large amount of thrust combined with heavy braking will deteriorate the yaw stability of the aircraft. During reversal a special autopilot mode is engaged (if SPAK is engaged) which automatically applies rudder input to maintain stability. In case of loss of stability, immediately reduce thrust.

Gentle thrust reduction should be used at the latest when the REV AVDR / TRANSONIC light is lit so that idle thrust is reached when the aircraft has come to a stop. This is to prevent compressor stalls.

CAUTION: When reversing, do not apply the brakes until the aircraft has come to a stop, as this may cause the aircraft to pivot backwards.

LOWNAV HUD mode

With HUD Slave (SLAV-SI) in mode ON (T) and an altitude of less than 100 metres AGL, the LOWNAV (Decluttered HUD mode) activates.

The course scale can be displayed by pressing the reference button on the control stick.

Other functionality of the HUD slave (SLAV-SI) selector:

- Mode Off (F): no HUD slave or LOWNAV mode
- Mode ON (T): HUD slaved (centred) in LANDN P/O.
- Mode ON (T): normal mode in LANDN NAV

Instrument approach and TILS landing

TILS landing

1. Set landing base as destination. Press L MÅL.
2. Set QFE pressure on altimeter
3. Select runway heading (cycle runway heading, BANA/ UT (OUT) and press LS)
4. Set master mode LANDN NAV about 30 km away from the destination
5. Set Autothrottle ON if desired. Autopilot mode SPAK ON.
6. Follow steering commands on the HUD or ADI
7. If using TILS to land, check that TILS is locked (TILS light lit) and used after the LB turn is complete. If using a short approach set master mode to LANDN P/O and then return the master mode selector to LANDN NAV in order to select the touchdown point LF as destination.
8. Check backup artificial horizon. Fast erect if necessary.
9. Lower the landing gear about 15 km out from the runway
10. Set HUD reflector glass to landing mode about 14 km out.
11. Check that the TILS is locked (TILS light solid)
12. Follow steering commands on HUD or ADI. Maintain altitude and airspeed. The glideslope should be intercepted about 10 km from the runway.
13. On the descent command, follow the glide path steering commands in the HUD and ADI.
14. If desired, set AFK mode 3 (α 15.5)
15. On touchdown, follow normal landing procedures.

Alternate Runway heading selection.

Data selector in mode AKT POS / OUT.

Confirm landing base on the destination indicator.

Data selector in mode BANA/GRÄNS.

Runway heading is displayed on the data indicator.

Cycle runway headings by pressing once or multiple times until the desired runway heading is displayed.

Select AKT POS / OUT.

Flip-flop (shorten approach length)

1. Master mode NAV or LANDN NAV (or P/O)
2. Confirm selected landing base
3. Select master mode P/O, and then select LANDN NAV.
4. LF should be displayed on the destination indicator.

On passing LF, no automatic waypoint change occurs, but the course command “locks” in the runway heading. After a 90° turn, a new approach via LB is selected.

The pilot can always select a new approach via LB by setting the master mode selector to NAV, and then to LANDN NAV.

Data input

All inputs should be carefully entered as even small errors can lead to large navigation errors or substantial mission design errors.

The data selector should routinely be set to AKT POS after a completed input, in order to allow a manual waypoint selection.

In case of pressing a wrong button during input, cycle to IN/ OUT selector in order to clear the input window. If an erroneous input has been made, a new input can be used to overwrite it. In case an input is to be cleared completely, enter six zeroes 000000 onto that address, memory slot or waypoint.

IMPORTANT: If not loading the data cartridge or changing the take-off airfield, always at a minimum input start base (Either using reference number or longitude / latitude and runway heading) If this is not done, the navigation system will not function properly.

Note: In DCS, the starting airfield on spawn / mission start will always be entered automatically, but always should be verified.

Data cartridge loading

Insert the data cartridge into the data cartridge slot.

The data cartridge is loaded by setting the data selector to REF/LOLA and inputting the code 9099 and pressing LS / SKU to confirm. The data cartridge can only be loaded when the aircraft is on the ground.

Loading the cartridge will automatically clear previously entered mission data as well as TAKT addresses 20- 92.

During data transfer the entered code 909900 is shown in the data indicator, with the first 9 flashing. A failed transfer is indicated by the first 9 no longer flashing and the display showing 909900. A successful transfer is indicated by the data indicator displaying 000000.

The data cartridge will load the waypoints, however target waypoints, ingress waypoints and popup points will have to be loaded manually.

AKT POS

Output

Displays current position, TERNAV status and estimated navigation error.

REF LOLA

Input Start/landing base, alternate landing base, waypoints, mark points outside the navigation polygon.

Input Longitude / Latitude (LO/LA) coordinates or reference numbers on the waypoint B1-B9. Always input Longitude first.

In case the aircraft is to return to another airfield, input the landing base on the landing waypoint button L.

Alternate landing bases are entered as 99XX instead of 90XX. Only reference numbers can be used to set the alternate landing site.

E.g: If entering 9014 on the Caucasus map, Kutaisi airfield will be set as the primary landing base (L1). If entering 9914 instead, it will be entered as the secondary landing base (L2)

Input of mark points outside of the navigation polygon is done by inputting LO/LA, and then pressing the BX waypoint button and then pressing the number button on the data panel (BX1-BX5)

The BX6-9 are used for planning the RB 15 anti-ship missile's flight path and will be addressed in the RB15 procedures section.

Output Displays coordinates (LO/LA) or reference numbers.

- Check selected waypoint or start / landing base in the destination indicator
- Check the data readout in the data indicator

A non-destination waypoint can be checked by pressing and holding the desired waypoint button.

BANA / GRÄNS

Input

Runway heading, TILS channel.

In the case that the base (start or landing) the true runway heading (not magnetic) is entered in degrees (3 digits) on LS or L1. In case of further heading resolution is needed, tenth of a degree (single decimal) can be entered on the 4th digit. Runway headings cannot be entered on the alternate landing base (L2).

TILS channels are entered on the 5th and 6th digits next to the runway heading

Ex. Enter 268319, 268.3 being the runway heading with a single decimal, and 19 being TILS channel 19 on that airfield).

The TILS channels can also be manually selected via the TILS channel selector dial.

Developers note

All Airports and airbases have automatically been assigned TILS channels and reference numbers. Please refer to the in-game kneeboard for the map-specific numbers.

Output

Runway heading

1. Check selected landing base in the destination indicator
2. Runway heading and TILS channel numbers for L1 (L2) is displayed if L1 (L2) is the current destination and no waypoint button is pressed. If the landing waypoint button is pressed and L1 or L2 is not the current destination the runway headings for L1 and L2 will alternate in the data display.
3. If required, cycle runway headings once or multiple times by pressing the landing waypoint button until the desired runway heading appears. The destination indicator will display a flashing L to indicate that an alternate runway heading is used.

Boundary lines on CI

Input

For input of boundary lines towards waypoint B1-B9, three digits are entered for each direction. If only one line is desired, only the first three digits are to be used.

Output

1. Press the desired waypoint button.
2. Check the designation indicator.
3. The line's headings are displayed on the Central Indicator (CI)

The lines are cleared by inputting a single zero (0) on the waypoint.

Vind / RUTA / MÅL

RUTA / MÅL is addressed further in the reconnaissance section

Wind

Input

Forecasted wind is entered as degrees (three digits) and wind strength (two digits) in km/h. If input of forecast wind has been done while airborne, Doppler-derived wind is resumed by inputting a zero (0). Press LS to confirm.

Conversion:

1 km/h = 0.277 m/s

1 km/h = 0.53 knots.

Output.

1. Press and hold LS
2. Entered wind direction in degrees and wing strength (in km/h)

If airborne, the latest measured Doppler derived wind is displayed if no waypoint button is pressed.

The forecast wind display is indicated by a minus sign on the 6th digit.

RUTA (Reconnaissance square)

Please refer to the reconnaissance section at the end of the procedures chapter for further details

Input

1. Input LO/LA or reference number. *(Refer to the in-game kneeboard for map-specific reference numbers)*
2. Input is confirmed by pressing the corresponding waypoint button B1-B8. Corner points should be entered in sequence beginning with R1 (button B1).
3. If the sequence is “broken”, such as nothing being entered on R6 while values for R1-5 and R7; the following waypoints (in this case are considered “middle points”, and will not be part of the square display in the CI. R9 is always considered as a “middle point”.

Output

1. Press the corresponding square waypoint (B1-B9).
2. Check the destination indicator (R1-R9).
3. Read coordinates on the data indicator.

MÅL (Reconnaissance target)

Please refer to the reconnaissance section at the end of the procedures chapter for further details

Input

Manual input of coordinates for reconnaissance targets (red M1-M9) is done via input in mode date mode VIND / RUTA / MÅL.

Input longitude /latitude (six digits each) followed by pressing the L MÅL button, and confirming the target number by pressing the desired number of the data panel.

Ex. 331533 (E), 431535 (N), LMÅL, Data panel button 2 for Reconnaissance Target 2 (Red M)

Output

1. Press and hold the desired button on the data panel
2. Read the entered coordinates (LO/LA)

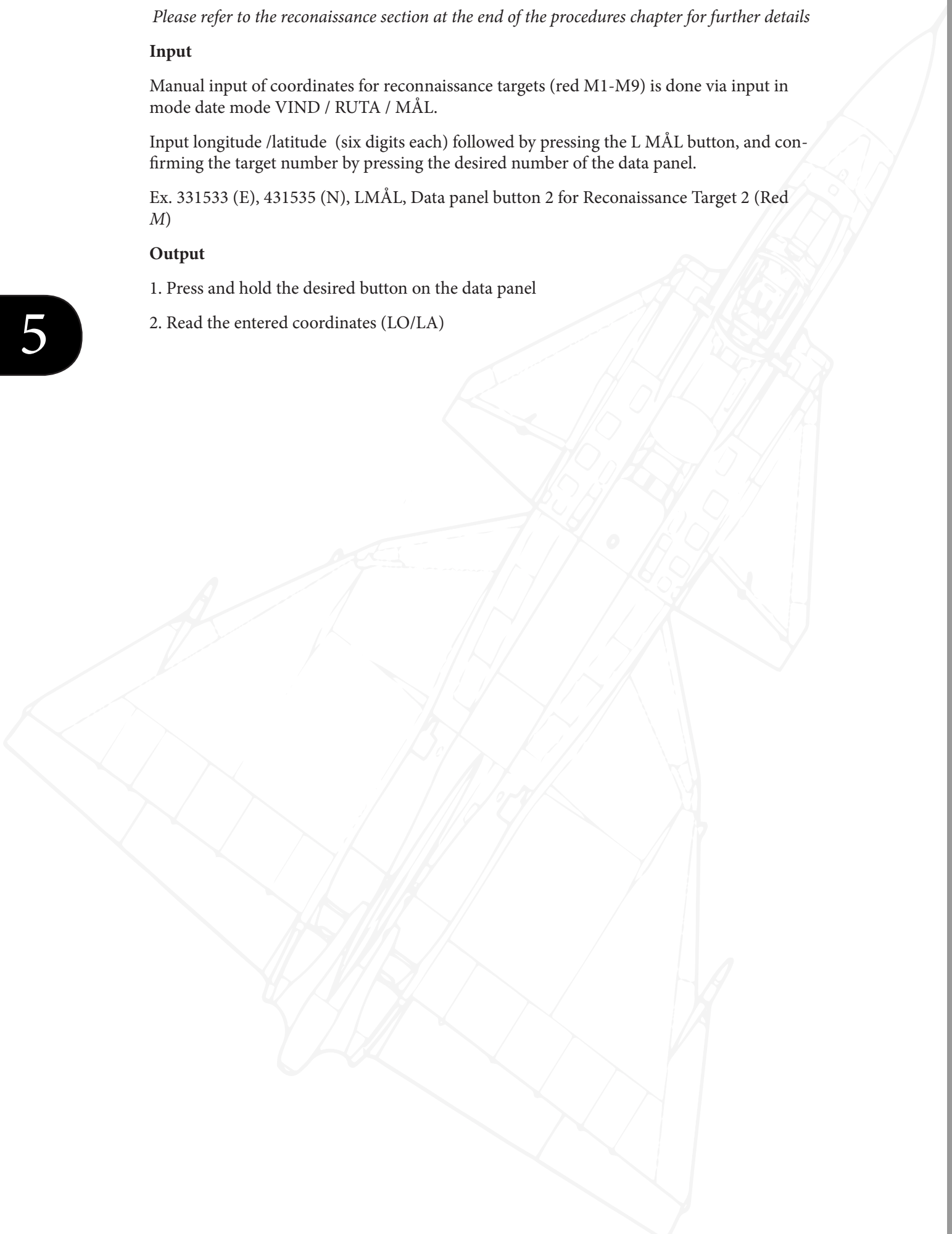

TID

Current time, Time on target

Input

Current time is entered as hours, minutes and seconds. Enter by pressing LS.

Time on target is entered likewise on B1-B9 that has previously been defined as a target waypoint. Enter by pressing the desired waypoint button.

Time on target (missile in target area) for the RB 15 is confirmed on pressing BX.

Output

1	Remaining time until take-off. Assuming the aircraft is on the ground and time on target is inputted. No - sign on the first digit indicates remaining time until take-off. - sign indicates that the take-off time has passed.	<table border="1"> <tr> <td></td><td></td><td></td><td></td><td></td><td></td> </tr> <tr> <td></td><td></td><td>h</td><td></td><td>min</td><td></td> </tr> <tr> <td></td><td></td><td></td><td></td><td></td><td>s</td> </tr> <tr> <td>1</td><td></td><td>0</td><td>0</td><td>2</td><td>2</td> </tr> <tr> <td></td><td></td><td></td><td></td><td></td><td>5</td> </tr> </table>									h		min							s	1		0	0	2	2						5						
		h		min																																		
					s																																	
1		0	0	2	2																																	
					5																																	
2	Number 7 indicates calculated flight time to target in hours, minutes and seconds, if no waypoint button is pressed, no time on target inputted and not in master mode SPA.	<table border="1"> <tr> <td></td><td></td><td></td><td></td><td></td><td></td> </tr> <tr> <td></td><td></td><td>h</td><td></td><td>min</td><td></td> </tr> <tr> <td></td><td></td><td></td><td></td><td></td><td>s</td> </tr> <tr> <td>2</td><td></td><td>7</td><td>0</td><td>2</td><td>5</td> </tr> <tr> <td></td><td></td><td></td><td></td><td></td><td>1</td> </tr> <tr> <td></td><td></td><td></td><td></td><td></td><td>0</td> </tr> </table>									h		min							s	2		7	0	2	5						1						0
		h		min																																		
					s																																	
2		7	0	2	5																																	
					1																																	
					0																																	
3	Calculated time error according to current mission layout. Time table error if no waypoint button is pressed, and time of target (or RB15 ToT) has been inputted. Shown in hours, minutes and seconds. - sign in front indicates BEHIND schedule.	<table border="1"> <tr> <td></td><td></td><td></td><td></td><td></td><td></td> </tr> <tr> <td></td><td></td><td>h</td><td></td><td>min</td><td></td> </tr> <tr> <td></td><td></td><td></td><td></td><td></td><td>s</td> </tr> <tr> <td>3</td><td></td><td>-</td><td>0</td><td>0</td><td>1</td> </tr> <tr> <td></td><td></td><td></td><td></td><td></td><td>2</td> </tr> <tr> <td></td><td></td><td></td><td></td><td></td><td>0</td> </tr> </table>									h		min							s	3		-	0	0	1						2						0
		h		min																																		
					s																																	
3		-	0	0	1																																	
					2																																	
					0																																	
4	----- if no waypoint button is pressed and in master mode SPA.	<table border="1"> <tr> <td>4</td><td></td><td>-</td><td>-</td><td>-</td><td>-</td> </tr> <tr> <td></td><td></td><td>-</td><td>-</td><td>-</td><td>-</td> </tr> </table>	4		-	-	-	-			-	-	-	-																								
4		-	-	-	-																																	
		-	-	-	-																																	
5	Current time in LS is pressed and held.	<table border="1"> <tr> <td>5</td><td></td><td>1</td><td>4</td><td>4</td><td>2</td> </tr> <tr> <td></td><td></td><td></td><td></td><td></td><td>1</td> </tr> <tr> <td></td><td></td><td></td><td></td><td></td><td>3</td> </tr> </table>	5		1	4	4	2						1						3																		
5		1	4	4	2																																	
					1																																	
					3																																	
6	Time on target if a target waypoint is pressed and held.	<table border="1"> <tr> <td>6</td><td></td><td>1</td><td>5</td><td>0</td><td>6</td> </tr> <tr> <td></td><td></td><td></td><td></td><td></td><td>0</td> </tr> <tr> <td></td><td></td><td></td><td></td><td></td><td>0</td> </tr> </table>	6		1	5	0	6						0						0																		
6		1	5	0	6																																	
					0																																	
					0																																	
7	Time on Target RB 15 missile if BX is pressed and held.	<table border="1"> <tr> <td>7</td><td></td><td>1</td><td>5</td><td>1</td><td>0</td> </tr> <tr> <td></td><td></td><td></td><td></td><td></td><td>3</td> </tr> <tr> <td></td><td></td><td></td><td></td><td></td><td>5</td> </tr> </table>	7		1	5	1	0						3						5																		
7		1	5	1	0																																	
					3																																	
					5																																	
8	00000 if waypoint button B1-B9 is pressed and no ingress waypoint or target waypoint is pressed and held.	<table border="1"> <tr> <td>8</td><td></td><td>0</td><td>0</td><td>0</td><td>0</td> </tr> <tr> <td></td><td></td><td></td><td></td><td></td><td>0</td> </tr> <tr> <td></td><td></td><td></td><td></td><td></td><td>0</td> </tr> </table>	8		0	0	0	0						0						0																		
8		0	0	0	0																																	
					0																																	
					0																																	

Ingress Mach speeds

Please refer Navigation System chapter for further details

Input

Input the desired Mach number with three digits. For example Mach 0.75 is entered as 075, and press the desired waypoint button. Note that the waypoint must be a normal waypoint (B1 - B9)

The entered Mach number lasts until the next ingress waypoint or to the waypoint after the last target waypoint. If no target waypoint is set, the set Mach speed lasts until the landing base L1.

If an economic airspeed is desired (at low altitude), input 055 for Mach 0.55.

Entered ingress Mach speeds are reset on clearing the mission data (Pressing the RENSA (CLEAR button) on the ground.

Output

Entered ingress speed is displayed if a waypoint button (B1-B9) corresponding to an ingress waypoint is pressed and held.

Fix timestamp for reconnaissance targets.

Please refer to the reconnaissance section at the end of the procedures chapter for further details

Input

Input of timestamps for reconnaissance targets is done by pressing the L MÅL waypoint button and confirming with the corresponding number on the data panel.

Output

1. Press the number button for the desired reconnaissance target on the data panel.
2. Read the entered time in hours, minutes and seconds. (Ex. 153030 for 15:30:30)

TAKT

Target waypoints

Please refer Navigation System chapter for further details

Input

Target waypoints are defined either by directly designating a waypoint as a target waypoint or by setting a pop-up position to a waypoint. Multiple target waypoints can be set.

A waypoint is defined as a target waypoint by entering the number nine (9) on the data panel and then pressing the desired waypoint. Once a waypoint has been defined as a target waypoint it is indicated in the destination indicator as an M point, e.g. B3 becomes M3.

To reset a target waypoint to a normal navigation waypoint, enter the number zero (0) and press the relevant waypoint button.

Output

Press and hold a waypoint button to check the status of that waypoint. If the waypoint is defined as a target, the data indicator will display 900000.

Popup point

Please refer Navigation System chapter for further details

Input

A popup point (U) is defined by entering the direction and distance **from** the popup point **to** the target waypoint with three digits (digits 1,2,3), and distance in whole kilometers with two digits (digits 4,5). Confirm by pressing the relevant waypoint button. Doing so will define that waypoint as a target waypoint if not done previously.

Ex.

165100 will set a popup point with a heading 165 **from** the popup point **to** the target point, with a distance of 10 kilometers.

Output

The first press of a target waypoint button corresponding to a waypoint with a popup point attached in mode AKT POS / OUT will select the popup point (e.g U5). The second press will select the waypoint itself (e.g. M5)

Addressed data in mode TAKT

Certain inputs in mode TAKT are used to set certain values for the computer to use. This is mostly done by inputting values onto a specific address in the computer's memory. The address number is the first two digits of the input window, and the A, B, C, D in the picture below are the value slots. For example 201, 1 (in slot A) being the value set for address 20.

Output of addressed data.

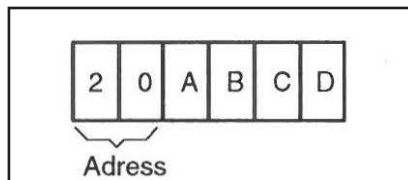

Fixed sight mode

Input address 21, value 1 (211). Confirm by pressing LS.

The fixed sight corresponds to the backup sight and can be used for AKA gun pods and ARAK rocket pods, RB75, and bombs.

Return to normal sight is done by inputting address 21, but adding no values. Alternatively, it can be cleared by pressing the RENSA (CLEAR) button in mode TAKT, this does however clear ALL values. The mode is also cleared on landing.

Parameters for the backup and fixed sights are in the weapons employment section of the procedures chapter.

Disable target motion measurement.

The target motion measurement for AKA gunpods in A/G mode, ARAK rocket pods and bombs for dive-bombing can be enabled with inputting address 22 and value 0 (220). Confirm with LS.

Developers Note: The target motion measurement has been disabled by default.

Illumination bombs (LYSBOMB)

An offset distance for the illumination bombs can be set in kilometres (1,2 or 3) on address 23. Confirm with LS. Returns to the default value of 2 km is automatic on landing or clearing in mode TAKT. Ex. 231 will enter 1 km offset.

Refer to the LYSBOMB procedures section for further details

Radar function for sight use.

Three different function can be used. Input is made on address 25 and the value seen below. Confirm with LS.

Value

1. Radar lock before trigger unsafe (Default mode)
2. Radar lock on/ after trigger unsafe
3. Radar lock disabled, sight only uses triangulation for ranging.
0. Same as 1.

Normal mode is resumed on clearing TAKT on the ground or when switching to master mode BER on the ground.

Standoff distance for reconnaissance.

Input address 30 and desired distance 0-99 km (digits 3 and 4). Confirm with LS.

Stand-off distance is just used in the reconnaissance mode to provide a warning from coming too close a reconnaissance target (such as being able to track them beyond visual range).

Refer to the reconnaissance procedures chapter for further details

Fuel minimum at L1

Input desired minimum fuel reserve at primary landing base L1 on address 51 and the desired value 10-99% (digits 3 and 4). Confirm with LS.

Weapons settings in TAKT

Addresses 81-88 are for the RB 15F and will be addressed in the RB 15 procedures section.

Addresses 91-92 are used for inputting BK 90 release parameters and will be addressed in the BK 90 procedures section.

Navigation

The navigation systems of the AJS-37 are largely automated. After data input, the systems will mostly operate automatically, but require pilot input for maintaining a good navigational position keeping. In order for the navigation and weapons systems to operate effectively, the pilot has to remain vigilant of the aircraft's assumed position and the "real" position of the aircraft. Large navigation errors should not occur if reasonably often navigation fixes are made.

Waypoint selection

Automatic waypoint change.

Navigation calculations automatically begin on take-off (initial fix).

After take-off from LS, when the airspeed is over M0.35, the system automatically switches to the first waypoint B1. On passing a waypoint, the next entered waypoint is selected, until the last entered waypoint is passed, where the primary landing base is selected (L1).

Waypoint LS is selected by pressing LS. The alternate landing base L2 is selected by pressing button L MÅL if L1 is the current destination.

If automatic waypoint change is not desired, preparing a visual fix will inhibit it:

1. Radar in mode A0
2. Select destination waypoint.
3. Press the fix trigger to the first detent (T0) and release.
4. On the destination indicator, an E is displayed instead of B, M or L.

The automatic waypoint change inhibition is cancelled after a completed fix or a manual destination change.

Automatic waypoint change is inhibited in visual fix mode.

Manual destination change.

1. Data selector in mode AKT POS / OUT.
2. Press the desired waypoint
3. A new waypoint should be displayed on the destination indicator.

Markpoints BX1-5 can be selected by pressing the BX button and then the corresponding number button on the data panel.

Waypoint LS is selected by pressing LS. The alternate landing base L2 is selected by pressing button L MÅL a second time if L1 is the current destination. Pressing L MÅL again will toggle between L1 and L2.

Navigation display and monitoring.

With the data selector in mode AKT POS / OUT, the position, TERNAV status and estimated position error is displayed.

On the destination indicator the current destination (selected waypoint) is displayed.

The course indicator (course bug) on the current bearing to the destination is shown. The aircraft is on the correct course if the course bug is on the fixed heading index (12 o'clock position). The course bug is adjusted for the necessary course correction due to wind.

On the HUD and ADI, the vertical flight director needle indicate the current course deviation.

On the distance indicator the current distance to the destination is shown.

The current position is degrees and minutes (four digits) of longitude and latitude are displayed on the data panel in mode AKT POS / OUT. The system will alternate between the longitude and the latitude. The latitude is indicated by the first digit flashing.

The estimated position error is indicated on the two last digits of the data indicator on the data panel in mode AKT POS / OUT. This status is estimated on the navigation system usage and time elapsed of flight.

On the Central Indicator (CI), the next waypoint is indicated by a nav-circle (with alternating GRÄNS boundary lines, if entered). If the landing base (L1 – L2) is the destination, the line represents the extended runway centreline.

If the light NAVSYST is lit, this indicates that either (or both) the Doppler has yielded an error for over 2 minutes or that the initial course setting has not occurred or have been degraded (due to a systems error or an ADI fast erect while airborne). The navigation system will then continue based on the magnetic course, which will yield larger position errors.

In case NAVSYST is lit:

1. Try to identify likely cause.
2. Ensure the functioning of the navigation system by making frequent fixes. *Please refer to the navigation fixes prodedures below.*

Economic airspeeds at altitude

Stored in the CK37 for fuel calculations

Altitude	Airspeed (Mach)
0 m (0 ft.)	M 0.55
3000 m (10,000 ft.)	M 0.66
6000 m (20,000 ft.)	M 0.76
9000 m (30,000)	M 0.86
10,000 m (33,000 ft.)	M 0.9

Navigation fixing (visual / radar / waypoint and target)

Please refer to the Navigation system section of the General systems overview Chapter for further details on the types of fixes and their effects.

Automatic fixes.

Initial fix

The initial fix is automatic during take-off when the nose-gear is lifted off the ground. The fix is set to the runway centre point.

If the aircraft has been landed without the master mode selector in a landing mode and the following take-off is done by not setting the start base in the navigation system by data input, the initial fix will not be set. Erroneous course setting may occur. For this reason, the start base should always be entered.

TILS-fix.

When using a TILS approach, during phase 3 with decreasing distance to LF, automatic TILS fixes are made to remove position errors in the navigation system based on the incoming TILS signals. TILS-fixes are indicated by eventual corrections in the navigations indicators (such as rapidly changing distance on the distance indicator).

TERNAV

TERNAV fixes are completely automatic if the system is operating and the radar altimeter is in use.

Manual Fixes.

Please refer to the Navigation chapter for further details on the differences between navigation and target fixes.

Manual fixes can be done either as visual fixes or radar fixes.

Fixes can be divided into two categories, own-position (navigation) fixes or target fixes. If a fix is made on a normal navigation waypoint, the fix will move the entire navigation polygon to correct the position error of the navigation error.

If a fix is made on a target position, only the target waypoint is moved, correcting its position within the navigation polygon.

Visual Fix

Visual fixes are done by first pull the fix trigger to the first detent T1 to prepare the fix taking mode, where an E is displayed in the destination indicator. The automatic waypoint change is inhibited in this mode. When the aircraft is over the known position of the waypoint, or the new target position, pull the fix trigger to the second detent (TV). After the fix is complete the next waypoint will automatically be selected.

Radar in mode A0 (turned off)

Confirm selected waypoint in destination indicator

Pull fix trigger to first detent, T1. "E" should appear on the destination indicator.

On passing the desired position, pull the trigger to the second detent (TV). Next waypoint should automatically be selected.

IMPORTANT

Note the risk of making a radar fix instead of a visual fix if the radar is **not turned off** (radar in mode A1 or A2). Radar fixes are indicated by a flashing E in the destination indicator.

Radar fix

Own position (navigation)

A radar fix allows the pilot to adjust the aircraft's own-position status by using the radar picture to verify position of the waypoint on a known geographic terrain feature. A navigation error is indicated by that the known geographic waypoint position is not in the centre of the navigation ring on CI.

Radar fix is done by pulling the fix trigger to the first detent (T1). The cross marker appears on the CI, and the radar grid (angle and distance markers) disappears to give clearer picture. The cross marker and waypoint circle are moved to the desired position with the radar control stick. When the cross marker is on the correct position, pull the fix trigger to the second detent (TV). The cross marker disappears and the waypoint circle will be on the new position to indicate that the fix has been completed. The radar grid returns in the CI upon completion.

5

1. Radar in mode A1. Master mode selector not in mode SPA
2. Confirm waypoint on destination indicator
3. Pull fix trigger to first detent, T1. Flashing E should appear on the destination indicator. Move the cross marker and waypoint circle maker (only waypoint circle in using memory mode) to the known waypoint or target position.
4. Pull the trigger to the second detent (TV) to complete the fix.

Target waypoints

Radar fixes on target waypoints are done in the same manner as radar navigation fixes, but instead of correcting to a known waypoint position, the radar is used to place the target waypoint on the desired target position rather than adjusting the aircraft's navigation system.

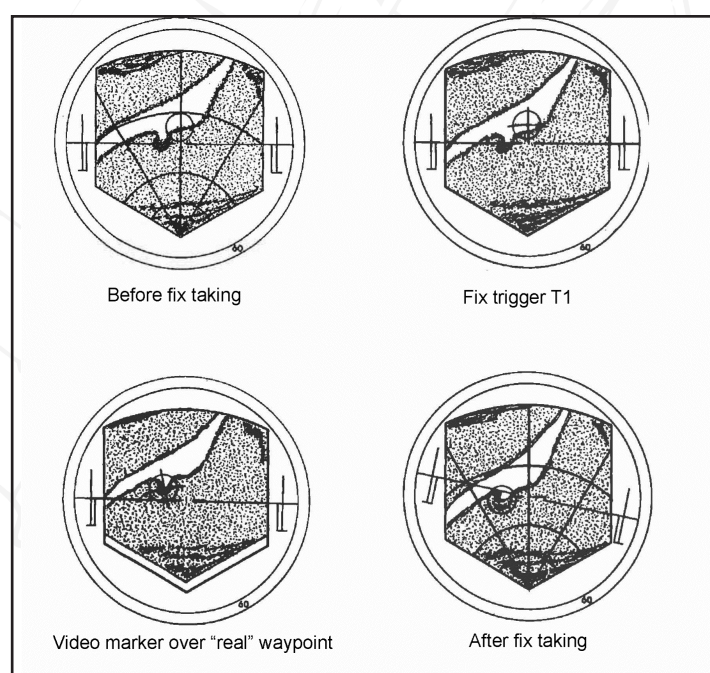

Figure 186. Radar target fix, target waypoint moved slightly left.

Radar Memory mode fix

Fixes can be made in memory mode. The picture will fade within 30 seconds. The cross will not be shown in the circle (since the cross is written by the radar beam and not the symbol beam of the radar scope).

Clearing of fixes.

The clearing of the corrections (position and course corrections) in the navigation system is divided into two steps. One press of the RENZA (CLEAR) button (in any other mode than SPA) will clear the latest manual own-position fix, as well as any TILS fixes.

The second press of the button (without an intervening own-position fix in between) will clear ALL position and course corrections.

This function can only be used when airborne.

6. AERODYNAMIC PROPERTIES



GSA (Autopilot turned off)

Pitch

The static longitudinal stability of the aircraft is throughout the entire airspeed envelope practically linear for all angles of attack between -10° and $+25^\circ$. The static longitudinal stability in relation to airspeed on a constant altitude (stick position and force applied as a function of the Mach number) is dependent of the following:

Mach ≤ 0.85

At airspeeds up to M 0.85 the stability is positive, so that the stick pressure has to be applied backwards on reducing the airspeed. The amount of pressure is dependent of the control system, as in pitch there is a variable gearing between the control stick and control surfaces that vary with airspeed and altitude.

Please refer to the flight control systems section of the systems overview chapter for further details.

Regarding the airspeed instability at low airspeeds, refer to the high AoA section below M > 0.85.

Mach ≥ 0.85

In this airspeed area certain instabilities emerge that vary with the flight altitude.

Please refer to the properties in transonic and high Mach speeds section in the pages below.

The dynamic stability of the aircraft (turning radius and time and dampening) is good at M 0.8 at low altitude and varies otherwise normally within the aircraft envelope. That is, the time of turn is longer when the airspeed decreases and / or the altitude increases and the pitch dampening decreases with increasing altitude and/or the airspeed is $> M 1.0$.

Elevator effectiveness is good throughout the entire flight envelope and the variable gearing between the control stick and control surfaces are mainly for the purpose of maintaining a suitable control sensitivity at all airspeeds. In order to maintain exchange at airspeeds M > 1.0 as with M < 1.0 , it is required that the gearing is changed in a special manner in relation to the Mach number. The pitch gearing is in this respect insufficient, which in combination with the reduced effectiveness of the control surfaces due to the wing's elasticity at high dynamic pressures and M > 0.95 yields a reduced maximum G-load.

Additionally, the maximum available G-load at M > 0.95 is partially limited by the maximum deflection of the control surfaces at full stick movement, as well as the maximum available torque. This leads to that the control surfaces authority may be insufficient to fully deflect at excessively high loads.

The control stick deflection as a function of g-load in any given flight regime is largely linear throughout the entire flight envelope. The stick movement per unit of G-load is about constant between 500 km/h and M < 0.95 . At transonic speeds, (M 0.95 – M 1.05), the stick deflection increases per G, where after the for higher Mach numbers it remains relatively constant.

In these events it should be noted that the neutral position of the stick may be further backwards and may be considered uncomfortable. By using the trim switch on the control stick, the neutral position of the stick can be moved.

Roll and yaw

The aircraft is statically stable in roll and yaw, and has a positive roll-yaw connection throughout the entire operational envelope during stabilised side-slips up the maximum side-slip corresponding to the maximum rudder deflection.

The yaw-roll oscillation (Dutch roll) is relatively poorly dampened and the dampening function reduces with increasing altitude. At high airspeeds the Dutch roll is mainly a pure yaw oscillation, but with increasing angles of attack the roll becomes more prominent.

The Dutch roll is the result of aileron (elevator) deflection and turbulence. It is first at angles of attack more than 12° that the Dutch roll has an effect on aircraft manoeuvrability.

Roll movements at low angles of attack (high airspeeds) AoA (α) 2° , yields a moderately contributing yaw during aileron deflection due to proverse yaw. In the angle of attack envelope α $2^\circ - 3^\circ$ a very pure roll movement is achieved due to the adverse yaw and inertial coupling cancelling each other out. During increasing angles of attack $\alpha > 3^\circ$ the inertial coupling becomes more prominent and leads to opposite yaw during aileron deflection (experienced as adverse yaw)

The inertial coupling, which results in angles of attack converting to side-slip when the aircraft starts to roll, leads to side-slip which causes the Dutch roll. The connection is troublesome during heavy manoeuvring in roll with angles of attack $\alpha > 15^\circ$ due to the induced Dutch roll results in an uneven roll-rate.

If large yaw-roll oscillations appear, the control stick should be moved gently and carefully (and if possible held in the neutral position in roll and if possible α reduced, wherein the oscillations are dampened). Stores attached to the fuselage pylons reduce the yaw-roll stability.

In yaw, the exchange between pedals and rudder are constant. Rudder input should be used carefully in order not to cause large amounts of side-slip unnecessarily.

In roll, the exchange between the control stick and control surfaces (roll gearing) has two positions that are determined by indicated airspeed. At $V_i > 350$ km/h the high-speed gearing is used. At V_i 350 km/h a conversion is made to low-speed mode to attain acceptable roll-rates during landing and low-speed flight.

Conversion time between the high and low speed modes is approximately 5 seconds.

Control surface effectiveness is good throughout the entire operational envelope of the aircraft, with exception of $> M 0.98$ at < 2000 m altitude, where the control surface effectiveness is reduced by elastic deformations of the wing. Within the Mach number area of $M 0.7 - 0.95$ at < 8000 m altitude, the roll control is relatively sensitive and high roll-rates are achieved. This can cause large side-slip angles which could endanger the structural integrity of the tailfin.

Flight at angles of attack $\alpha > 12^\circ$ should not be done in GSA (without autopilot)

Normal control mode (Autopilot enabled, SPAK)

Pitch

The flight properties of the aircraft in pitch are considerably improved when the SPAK autopilot mode enabled. The static properties are changed relatively little.

Yaw and roll.

As with the pitch, the flight properties are considerably improved with autopilot mode SPAK enabled. Especially noticeable is with the dynamic properties and this makes it possible to fly with large angles of attack during normal landing.

With flight in mode SPAK, the difference between a clean aircraft and an aircraft with stores hung on the fuselage pylons are much less noticeable than without the autopilot. The yaw stability in transonic speed as well as the static stability of the entire flight envelope is improved.

Airbrakes

When extending the airbrakes a strong nose-down trim change occurs in transonic speeds. Due to this, the airbrakes $\geq M 0.92$ cannot be extended, and are automatically retracted.

Properties in transonic and high Mach speeds

The aircraft has good properties at high Mach numbers.

In the control mode without autopilot (GSA), within transonic airspeeds ($M 0.85 - 1.03$) certain pitch trim changes occur that vary with altitude (Mach tuck).

At low altitudes without autopilot, a slight, nose-down pitch trim begins around $M 0.85$, which at $M 0.95$, transitions to a nose-up trim change. At airspeeds $> M 1.03$, the trim change is a weaker nose-down moment, but becomes progressively stronger as airspeeds increase to $\geq M 1.2$.

At medium-high to high altitudes, a moderate nose-down trim begins at $M 0.95$. The trim change exists throughout the supersonic area.

In normal control mode SPAK, at $M 0.95$ a slight nose-down trim begins, which at $M 1.03$ becomes negligible. At high Mach numbers, varying with altitude, the moderate nose-down trim returns, dependent on whether the series trim authority is exceeded.

Control surface effectiveness at supersonic airspeeds is somewhat reduced in comparison to subsonic speeds. Control stick movements in pitch and roll thereby are somewhat larger.

High angles of attack

Load factor = 1 G.

When the airspeed decreases, the angle of attack increases, light shakes appear at $\alpha 10^\circ$. At angles of attack for landing $12 - 15.5^\circ$, the oscillations are still light and do not increase noticeably for increasing α .

In order to make routine landings on short runways possible, it is necessary that the aircraft can be flown at relatively low airspeeds, that is with high angles of attack. With all the available aids (Autopilot and Autothrottle) the flight properties are very good, however certain properties of the aircraft should be kept in mind

The aircraft is unstable in airspeed below 365 km/h due to the double delta planform of the aircraft.

Excess thrust available at military power (max dry thrust) may be limited during normal descent speeds.

Drag is markedly large at high angles of attack. This leads to large portions of the available thrust (without engaging the afterburner) is being used up during normal approaches.

At normal landing weights ($W < 13000$ kg), an airspeed corresponding to $\alpha 15.5$, the available thrust excess is enough even on a hot day. However, if the aircraft weight is above 14000 kg, the thrust is deemed insufficient during a high angle of attack ($\alpha 15.5$) landing. Thereby landings at $\alpha 15.5^\circ$ is prohibited during landings with high landing weights.

During landings, the pilot should be vigilant and monitor airspeed, as it is easy to lose airspeed very quickly during turns and descents unless sufficient power is applied.

Load factor > 1 G.

The drag increases greatly with increasing angle of attack. The airspeed loss is therefore large during turns with high g-load, if the loss of airspeed is not compensated by increased thrust or altitude loss. Very tight turns can be made with the aircraft, but it requires large amounts of thrust (often using afterburner) in order to not lose excessive airspeed.

Quick movements of the control stick may therefore lead to exceedingly high g-loads. Therefore, the pilot should avoid sudden stick movements. In order not to lose excessive airspeed during flight at high g-load, the pilot should increase thrust before the control stick input, so that the thrust increase occurs at the same time as the g-load increase.

Light shakes begin at $\alpha 4 - 5^\circ$. The shakes increase somewhat with increasing angles of attack, where after the level of shake is about constant for $> \alpha 12^\circ$. The level of shake does not affect the manoeuvrability or the ability to aim. At supersonic speed no shakes appear for any g-load.

During heavy roll input during g-load with low speed $V_i < 350$ km/h, high roll rates can be achieved as the g-load decreases. This should not be confused with inverted spin. If the roll input is neutralised, the roll ceases and the g-load returns to normal.

Aerobatics

Aerobatics is easily performed with the aircraft, but due to large amount of induced drag during flight at high angles of attack, maneuvers requires large amounts of thrust and particular attention to angle of attack, airspeed and G-load.

Caution: Time of flight with negative G is limited by the engines oil system as well as the fuel reserve in the buffer tanks (about 10 seconds). The OLJETRYCK (Oil pressure) will appear to indicate reduced oil pressure. If negative g-load is maintained, there is a risk of engine damage due to lack of lubrication.

7. WEAPONS EMPLOYMENT



This page intentionally left blank

1. Trigger safety bracket.
2. EP-13 indicator
3. Stores released indicator light (FÄLLD LAST)
4. RB 05 control unit
5. Emergency stores jettison (NÖDF VAP)
6. Weapon selector
7. Sight mode selector
8. Release mode selector
9. Targeting mode selector / preparation (MÅLVAL / PREP)
10. Data panel
11. Ground safety bypass (FÖRBIK AVFYRNINGSKRETS)
12. Brightness / Contrast dials for EP-13 sight
13. Missile tone / RWR warning volume (LJUDSTYRKA UK-DÄMP)
14. Missile select button IR-RB FRAMSTEGN
15. Fix trigger
16. Radar mode selector
17. IR missile uncage
18. Trigger
19. (In appartus bay, not accessible in DCS)
20. (In appartus bay, not accessible in DCS)
21. (In appartus bay, not accessible in DCS)
22. (In appartus bay, not accessible in DCS)
23. (In appartus bay, not accessible in DCS)
24. (In appartus bay, not accessible in DCS)
25. (In appartus bay, not accessible in DCS)
26. (In appartus bay, not accessible in DCS)
27. (In appartus bay, not accessible in DCS)
28. (In appartus bay, not accessible in DCS)
29. AFK quick disconnect / IR missile fast select.

1. Trigger safety bracket.
 - » Mechanically locks and unlocks the trigger (similar to the safety on a firearm). Opening and closing will also affect a micro breaker which will enable firing circuits and release calculations. The pilot should thereby be very careful of when the trigger safety is opened.
2. EP-13 Indicator.
 - » Collimated sight for the Rb-75 (AGM-65).
3. Stores released indicator light (Fälld last)
 - » Indicates that weapons have been released. Lit for successful release, flashing for failed.
4. Rb-05 Control unit.
 - » Controls the Rb-05 MCLOS missile. Force sensing (stick does not move)
5. Emergency stores Jettison (NÖDF VAP)
 - » Jettisons all on-board weapon stores with the exception of RB 24J in the outer wing pylons and the bomb racks (bombs are released without being armed). Under a transparent protective cover.
6. Weapon Selector knob
 - » Selects weapons by type. Further details in the weapons & mode selection section below.
7. Weapon sight mode selector
 - » Changes some of the aiming parameters such as impact intervals for bombs or wingspan of aircraft for the A/A sight, or the left / right offset on the illumination bombs.
8. Weapon release mode switch
 - » Sets either SERIE (series) or IMPULS (single) release of the RB 04 and RB 15 or sight calculation for the rockets for normal mode (NORM) long range mode (LA).
9. Targeting mode selector / weapon preparation (MÅLVAL/ PREP)
 - » Changes the RB 04 radar to focus on either single or grouped targets. RB-15 or BK 90 settings are toggled between standard setting values and custom entered values.
10. Data panel
 - » In mode TAKT certain settings for weapons can be made. Also used to display weapon status.
11. Ground safety bypass switch (FÖRBIK AVFYRNINGSKRETS)
 - » Bypasses the safety system for the aircraft on the ground.
12. Brightness / contrast for EP-13 sight
 - » Sets brightness / contrast for RB 75 (AGM-65).
13. UK DÄMP Master volume control
 - » Volume for IR-missile seeker head.
14. Missile select button
 - » Selects the next IR-missile, RB 15, BK 90 or RB 75.
 - »

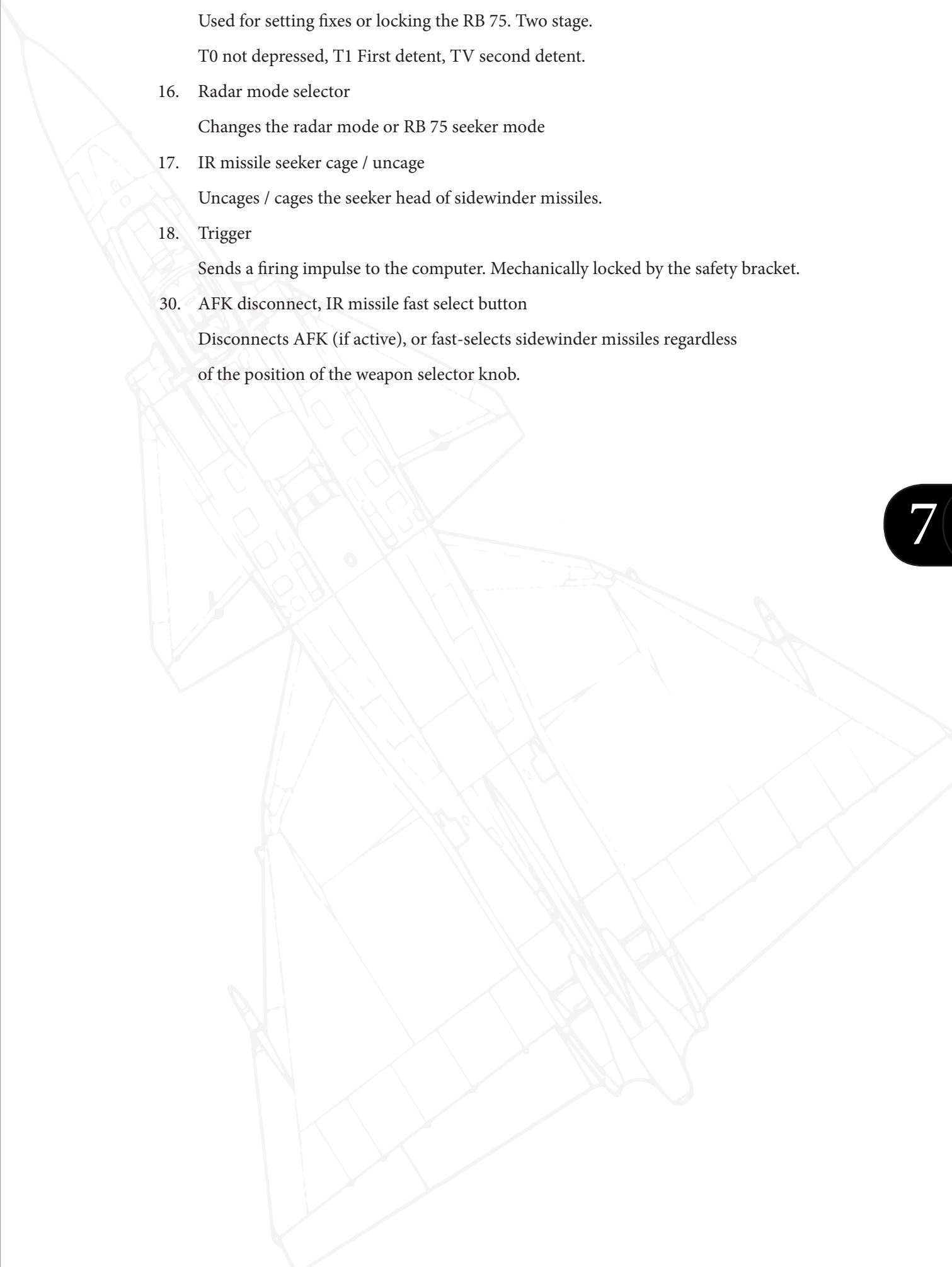
- 
15. Fix trigger (on radar stick)
Used for setting fixes or locking the RB 75. Two stage.
T0 not depressed, T1 First detent, TV second detent.
 16. Radar mode selector
Changes the radar mode or RB 75 seeker mode
 17. IR missile seeker cage / uncage
Uncages / cages the seeker head of sidewinder missiles.
 18. Trigger
Sends a firing impulse to the computer. Mechanically locked by the safety bracket.
 30. AFK disconnect, IR missile fast select button
Disconnects AFK (if active), or fast-selects sidewinder missiles regardless of the position of the weapon selector knob.

Weapons & mode selection

Weapon selector

The weapon types are selected via the weapons selector dial. Rather than selecting a weapon pylon, it selects a weapon type. The knob has six positions.

Each position of the knob may be used to select multiple types of weapons, however loadout limitations prohibit multiple weapons types on the same position of the knob to be carried. For the example position 2 has RB75/ MARK / DYK. Which would either select the RB 75 missile, the RB 05 in A/G mode, or set the bombs aiming for dive bombing.

In case of an incorrect selection of weapon type, the HUD presentation will be turned off either when selecting ANF on the master mode selector or opening the safety bracket.

It has 6 positions:

SJÖ /PLAN: Sets RB 05 for anti-ship fusing or bombs to be dropped in level bomb release.

RB75/MARK/DYK: Selects RB 75, RB 05 in Air-to-Ground fusing, or bombs for dive-bombing.

LUFT/RR: RB-05 in A/A mode, radar bomb release.

AKAN JAKT: Gun pods A/A mode.

ATTACK: Selects the majority of A/G weapon types.

IR-RB: Selects sidewinder missiles. (Can also be selected by a fast selector on the throttle instead)

Important

Due to the design of the weapons system and the aircraft computer, it is not possible to combine different types of air-to-ground ordnance. Any valid loadout can be combined with Sidewinder (RB24/ 24J /RB74) air-to-air missiles.

For example, the aircraft *can not* carry RB-04 Anti-ship missiles at the same times as ARAK rockets, or multiple types of air-to-ground missiles.

Even if weapons would use separate weapon selector slots, it is not possible.

Exception:

There is one exception and that is the combination of AKAN gunpods with *either* RB75 "Maverick" or RB05A missiles

e.g:

RB05A + AKAN

RB75 + AKAN

Master mode selector

The master mode during weapons employment can be set either in ANF (attack mode) or NAV (navigation mode). This will often result in different sub modes of each weapon system. If mode NAV is selected, the weapons display will begin when the trigger is set to unsafe.

Trigger safety bracket.

The trigger safety functions both as a mechanical lock on the trigger, as well as a arming switch for the weapons systems. A micro breaker is situated beneath the safety bracket which will activate when the safety is off. This impulse will have different functionality depending on the weapons mode. Therefore it is important for the pilot to be aware of when to open and close the safety bracket.

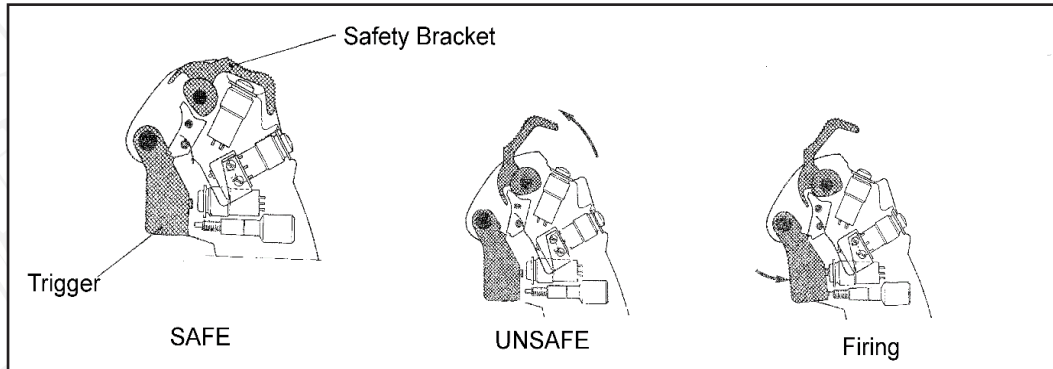
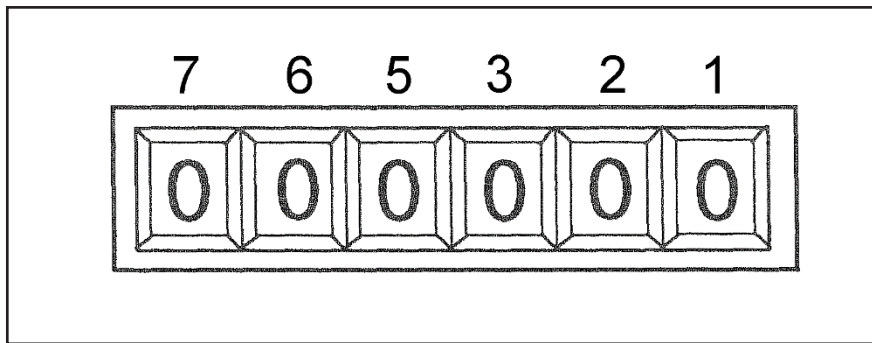

Figure 188. Trigger safety bracket

Data panel weapons status & release indication

The current stores status can be displayed on the data panel. With the IN/ OUT selector in position OUT, in any other mode than ID-NR the weapons status will be displayed in the following situations:

- » The Missile selector FRAMSTEGN is pressed
- » Trigger safety unsafe
- » Weapons error (FÄLLD LAST flashing)
- » Data selector in mode TAKT



Each number corresponds to each of the weapons pylons (1 being the right outer wing pylon).

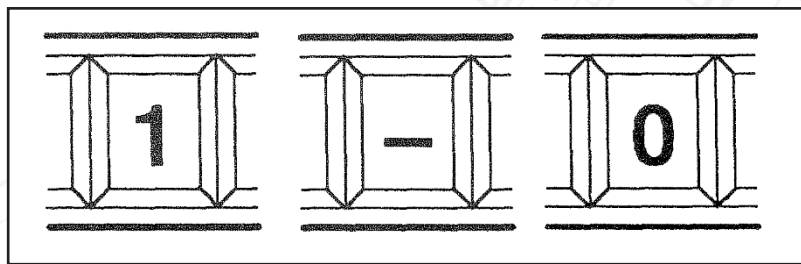

The following indications for the weapons

1 : Indicates that the pylon has a weapon attached and the weapon is fully functioning and ready to be used.

- : indicates the weapon has an error and is unusable.

0 : Indicates that the weapon has been released.

The Selected pylon is indicated by a flashing symbol.

A flashing FÄLLD LAST light (front panel top-right) indicates:

- Degraded weapon status
- Separation failure after firing. Applies for RB 04, RB 15, BK 90, RB24/74
- Separation failure after jettison. Applies for all weapons except RB24 in the outer wing pylons (cannot be jettisoned)

Missile & Pylon selection

Missile select button IR-RB FRAMSTEGN

For the RB 04E, RB 05A, RB 15, BK 90 and RB 75 missiles, the left missile is selected first.
For the RB 05, RB 15, BK 90 and RB 75 and Sidewinder (RB 24/74), the next missile may be cycled to by pressing the missile select button IR-RB FRAMSTEGN.

The missile order is always as follows.

Left outer- Right outer, Left inner, Right inner, Left fuselage, right fuselage.

Sighting mechanics

The aircraft will carry out the sight calculation based on a number of variables and inputs stored and processed by the central computer. However, most important is the ranging.

The aircraft can determine its range to target based on a number of manners depending on the weapon type and selected mode. For the unguided weaponry, the distance to target (slant range) is vital for correct sight calculations.

This distance can be determined in two manners, either by triangulation or by radar ranging.

Triangulation (computer calculated range)

Triangulation is determined by the computer calculating based on the aircraft barometric altitude and the angle the aiming reticule is pointing relatively to the horizon.

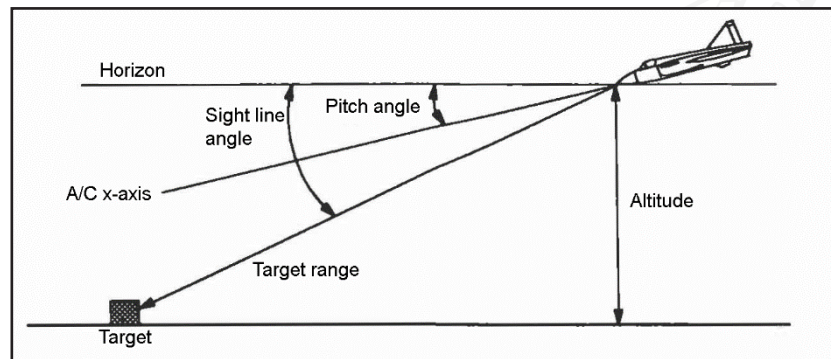

Figure 189. Triangulation

During A/G use of the gun pods and rockets, Rb75 (AGM-65) and bombs in precision release (sub mode of dive bombing), sight calculation begins with triangulation. A precondition for triangulation is that the angle between the horizon and the sight line is more than 5° in master mode ANF before unsafe or in master mode NAV after unsafe. Ranging is indicated by the distance line appearing at the bottom of the HUD.

For level release of bombs, the triangulation starts directly when the master mode ANF or if trigger unsafe in master mode NAV independently of the sight angle. The range is not calculated for infinite ranges or negative angles and the sight line in this mode may be hovering around 0° .

Note: Errors in the pitch angle from the aircraft instruments or an erroneous altimeter pressure (QFE altitude) setting will yield inaccuracies in the sighting system.

Radar ranging.

For some weapon modes, when in master mode ANF, the radar will range the distance to the target if the triangulated range is about ≤ 7000 m.

In modes DIVEBOMB, ARAK (rocket pods), AKAN A/G (gun pods in air-to-ground) and RB75 (AGM-65) the radar range may be used before trigger unsafe, assuming the bank angle is less than 45° . In LEVEL BOMB the trigger must first be unsafe. If the bank angle is more than 45° , radar ranging is enabled after the aircraft has a bank angle less than 45° .

Radar ranging is indicated by the “fin” appearing in the HUD above the sight dot.

The radar will range to the spot that the sight reticule (dot) is aiming at. As the radar will determine more or less the exact distance to the aiming point, yielding far more accurate sight calculations (particularly against inclined ground) than triangulation based on QFE. Radar ranging is thereby preferable than triangulation due to this increased accuracy and greater flexibility with varying terrain elevation.

If radar ranging is used, no radar display is shown in the Central Indicator for the duration of its use.

Radar ranging can be disabled via the data panel in mode TAKT/IN and inputting address 25 and value 3 (enter 253). Confirm by pressing LS.

Fixed range

The above ranging does not occur due to an excessively shallow angle (sight angle less than 5° from the horizon). The computer will calculate the firing solution based on a fixed range of 1400 metres. Range, firing commands or pull-up warnings are not given and must be estimated by the pilot.

Target motion measurement

There is a function of the gun sight that can take into account the target speed. The sight is used to calculate lead on the target by using the movement of the sight dot over the ground.

After setting the trigger safety to unsafe, the motion of the reticule during around 3 seconds will be added to the firing solution. Therefore it is important to be properly sighted onto the target before opening the trigger safety.

The pilot has to be careful to keep the reticule on the target to avoid sighting errors.

This mode only applies if ARAK rockets / AKA Gunpod in air-to-ground mode in master mode ANF and the SB/71 bombs in sub-mode Precision release of Dive-bombing (DYK/ANF).

Note: This system has been disabled by default in DCS due to marginal utility and for its difficulty in use.

Target motion measurement can be enabled /disabled via the data panel in mode TAKT/IN and inputting address 22 and value 0 (enter 220) to enable or value 1 (enter 221) to disable. Confirm by pressing LS.

HUD & CI Element weapons symbology

Below the different HUD elements of the aiming modes are detailed. Note that some of the same symbols have different uses in the different mode, and thus may be slightly confusing.

A/G modes



Figure 190. HUD in A/G rockets mode.

A/A modes



Figure 191. HUD symbology for IR missiles without radar lock with an uncaged seeker.

Backup and fixed sight

In case of primary data failure (main pitot system), or if the mode is selected manually, a fixed sight will be displayed. Only a single ring depressed to a specific angle is shown. The pilot will have to fly according to the parameters below in order to hit the target aimed at using the sight.

The sight ring is 0.5° in diameter, which corresponds to 8.7 milliradians.



Figure 192. Backup sight symbology (in this case for rockets).

The sight mode may be activated via Input address 21, value 1 (211) in TAKT/ IN for ARAK, AKAN (A/G), Bombs, and RB 75.

Please refer to the data input/ output section of the procedures chapter.

The sight depression indicated below is the amount of degrees offset from the aircraft x-axis (vertical the direction the aircraft nose is pointing)

<p>Gunpod A/G (AKAN ATTACK)</p> <p>Sight depression 2.3°</p> <p>Dive angle 7°,</p> <p>Speed: M0.8,</p> <p>Distance 1500 metres.</p>
<p>Rocket pods (ARAK)</p> <p>Sight depression 2.8° with altitude fusing</p> <p>Sight depression 2.3° without altitude fusing</p> <p>Dive angle 7°,</p> <p>Speed M0.8,</p> <p>Distance 1500 metres.</p>

Gun pods A/A (AKAN JAKT)

Sight depression 1.5°

Own aircraft: M 0.8,

Target airspeed: M 0.55,

Distance 500 metres.

Illumination bombs (LysB)

Popup with 5G after popup point and release 5 seconds after popup. Bombs released directly after trigger pulled with an interval of 150 ms.

General purpose Bombs (120kg M/71)

Precision / fast release.

Sight depression 3.8°

M0.8

Dive angle 7°

Corresponds to an impact interval of 20 metres with 16 bombs without brake chutes

Level / Radar / NAV release

Sight depression 5.0°

Optimised for altitude 120 m, M 0.8, no dive angle and a release distance of 1500 metres.

Direct release / CCIP

Sight depression 5.0°

With and without brake chute. Same as Level /Radar / NAV

Rb 75 (AGM65)

Sight depression 1.3°

Same as normal sight use

Rb 24J / 74 (Aim-9 Sidewinder), RB05 A/A

Sight depression 0° (if on inner wing and fuselage pylons)

Sight depression 0.8° (if on outer wing pylons)

Same as normal sight use.

Air to Ground

ARAK M/70B rocket pod / Gun pod AKA M/55 A/G

The AKA gun pods and ARAK rocket pods share the same sighting mechanics and their employment can be considered more or less identical, with the exception of the shorter range of the gun pods.

ARAK

The ARAK M/70B rocket pods are used against most types of ground units, ranging from soft targets to armoured units or installations.

The pods can be loaded with either High-explosive or Armour-piercing rockets. The armour piercing rockets have a smaller area of effect, but are far more effective against armour.

The rockets can be employed in three modes, the normal mode (master mode ANF), "Quick" mode (master mode NAV), or the Long range mode.

The Normal mode (master mode ANF), uses the radar for ranging and will be the most accurate, as it is not dependent on a very accurate QFE setting.

The Long Range mode is used for stand-off target suppression or when high degrees of accuracy is not necessary. The mode will inherently be less accurate, but offers the ability to launch the rockets with some degree of accuracy at up to 6-7 km range, thereby placing the aircraft outside of anti-aircraft fire and other shorter range air defence assets

AKA

The gun pod is loaded with 150 high-explosive rounds per gun. The gun can be used against aircraft, soft-targets and lightly armoured vehicles, but is mostly ineffective against armoured vehicles.

Rocket/ Gun pod attack profile.

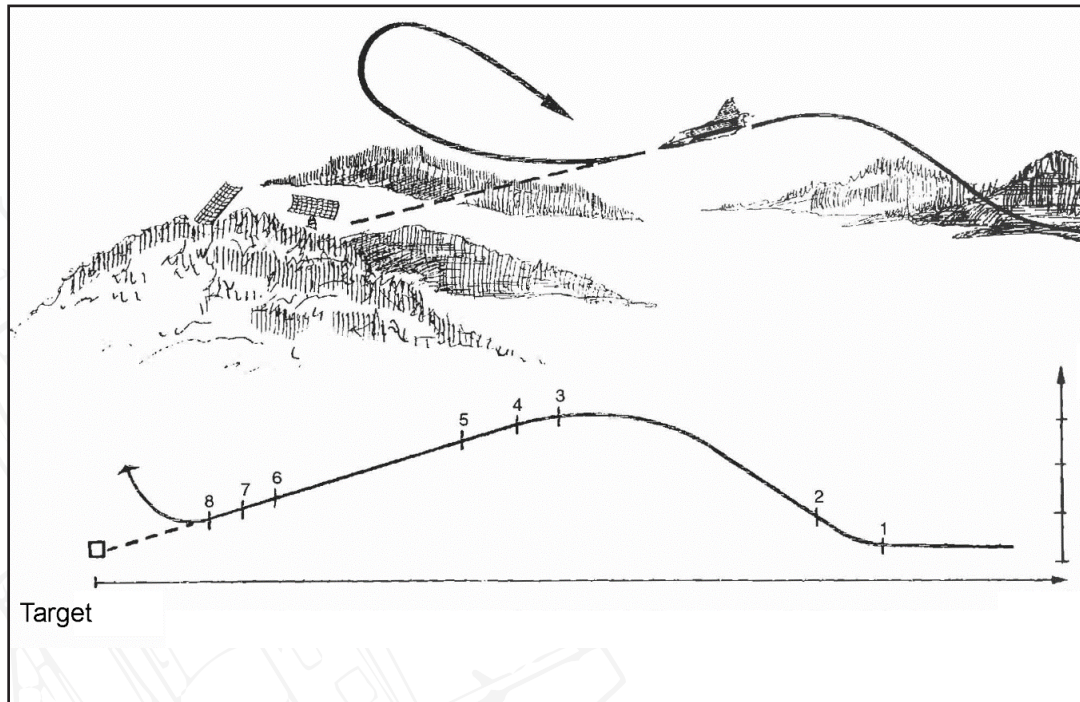

Figure 193. Rockets and gun pod attack profile.

- | | |
|---------------------|-----------------------------|
| 1. Pop-up | 5. Radar ranging begins** |
| 2. Master mode ANF* | 6. Earliest firing distance |
| 3. Triangulation | 7. Latest firing distance |
| 4. Trigger UNSAFE | 8. Pull-up & evasion |

* Also in mode NAV after trigger UNSAFE

** Radar ranging may also engage before trigger UNSAFE

Procedures

HUD elements



7

Figure 194. HUD symbology.

Figure 195. Rocket sight in mode ANF. Sight dot and distance line indicating countdown to optimal release distance. Firing cue "wings" not visible yet.

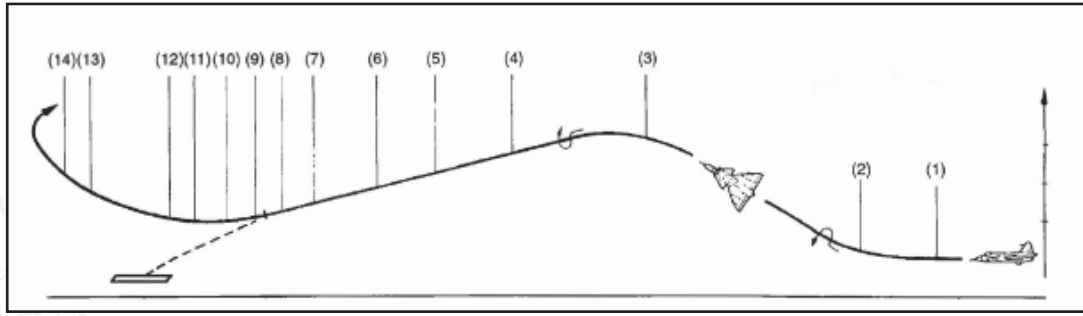
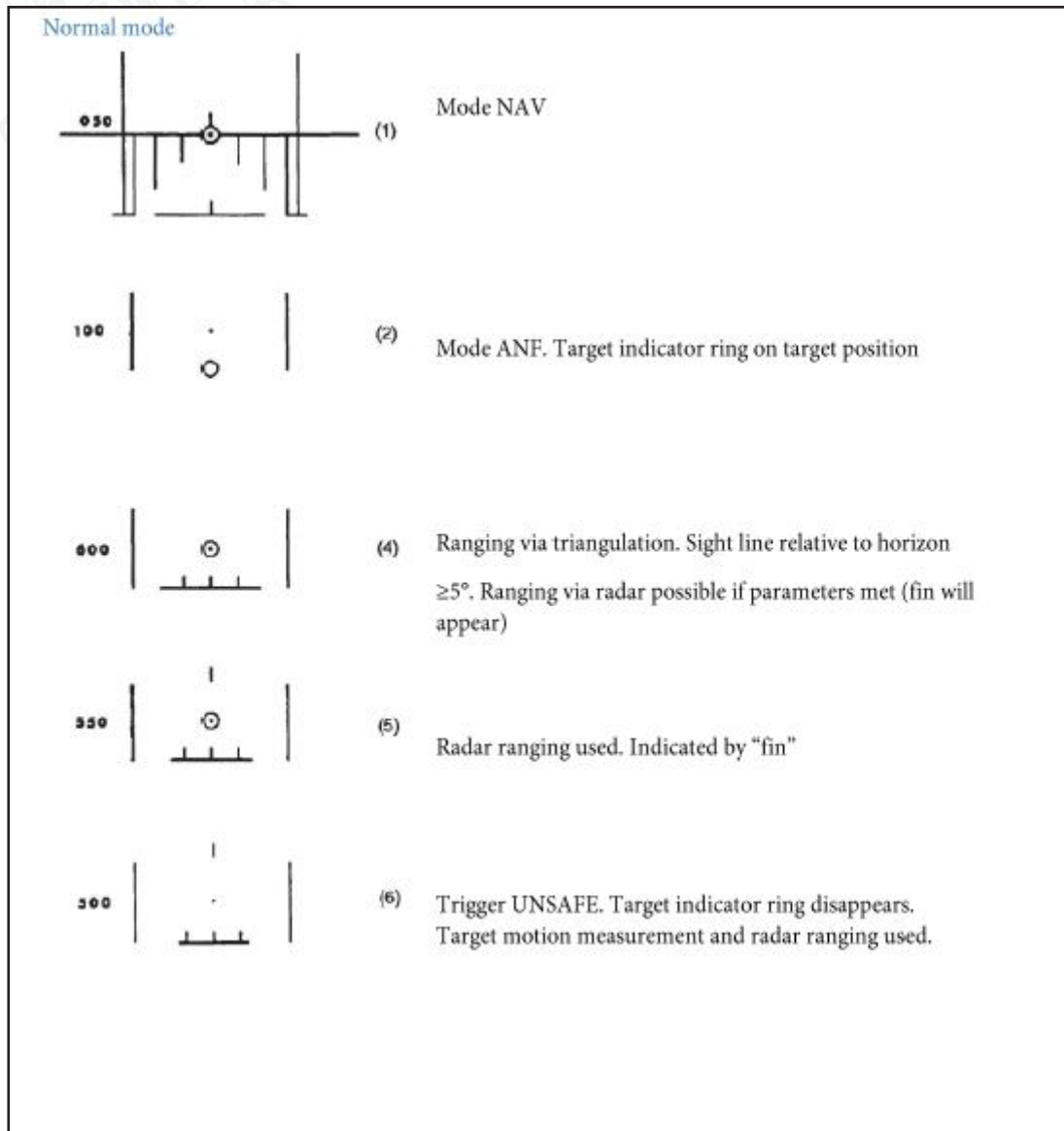
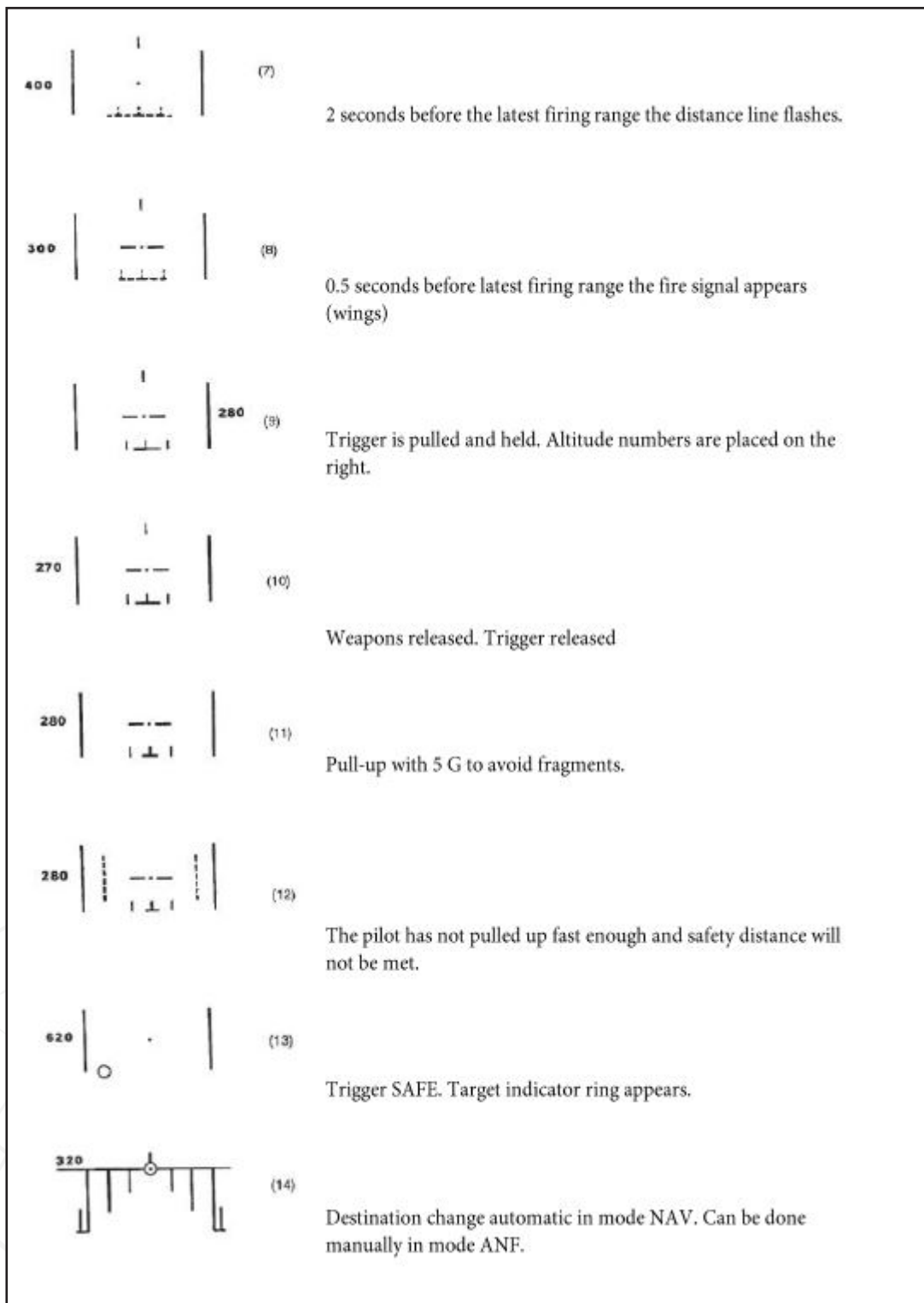

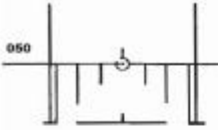



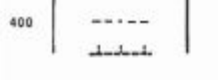

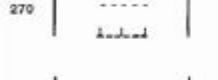
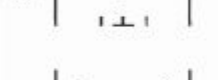
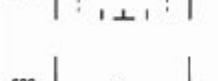

Figure 196. Rocket attack phases.

Normal mode





ARAK Long range mode

	(1)	Mode NAV
	(2)	Mode ANF. Target indicator ring on target position
	(4)	Ranging via triangulation. Sight line relative to horizon $\geq 3^\circ$.
	(5)	Wings indicate that the firing range and parameters for rockets are met.
	(6)	Trigger UNSAFE. Target indicator ring disappears. Doppler wind frozen.
	(7)	2 seconds before the latest firing range the wings and distance line flash.
	(9)	Trigger is pulled and held. Altitude numbers placed on the right.
	(10)	Trigger released.
	(11)	Wings disappear. Latest firing range has been passed.
	(12)	Pilot has not pulled up fast enough. Safety distance will not be met.
	(13)	Trigger SAFE. Target indicator ring appears.
	(14)	Destination change automatic in mode NAV. Can be done manually in mode ANF.

ARAK /AKAN Normal mode checklist

1. Weapon selector: ATTACK.
2. Release mode switch SERIE / IMPULSE: SERIE.
3. Set current altimeter pressure (QFE).
4. Master mode ANF (or NAV and UNSAFE).
5. Trigger UNSAFE when the reticule in on the target and stable.
6. Fire between the earliest and latest firing distances.
7. Evade, Pull-up with 5 G.
8. SAFE and select master mode NAV.

ARAK Long range mode (Rockets only) Checklist

1. Weapon selector: ATTACK.
2. Release mode switch: SERIE / IMPULSE – IMPULSE.
3. Disable target motion measurement (address 21, value 1).
4. Disable radar ranging (address 25, value 3).
5. Set current altimeter pressure (QFE).
6. Master mode: ANF.
7. Trigger UNSAFE when the reticule is on target and stable.
8. Fire when parameters are fulfilled (wings displayed).
9. Evade, Pull-up with 5 G.
10. SAFE and select master mode NAV.
11. **Note:** The long range is less accurate, but allows some stand-off range.

Notes.

- For AKAN gun pods, the sight may not be entirely correct until the firing signal. For ARAK rockets, the sight is mostly correct at the earliest firing distance and fully correct at the firing signal.
- If the angle between the sight line and the horizon is less than 5°, the distance line does not appear and the triangulation or radar ranging is not used. A fixed distance of 1400 m is used, which will have to be estimated visually.
- If the long range mode is used or the radar ranging is disabled, the triangulation will be set for a sight line of 3°.
- If the flashing 2° poles appear, the attack should be aborted **immediately** and evasion with maximum G should be done as the safety distance will not be met.

- Automatic waypoint selection is not used in mode ANF. Manual destination change may be used.
- The weapons can also be used in master mode NAV. The sight appears when the trigger is set to UNSAFE. Target motion measurement and radar ranging are not used.

General purpose bomb M/71 120 kg Sprängbomb (SB71)

Modes overview

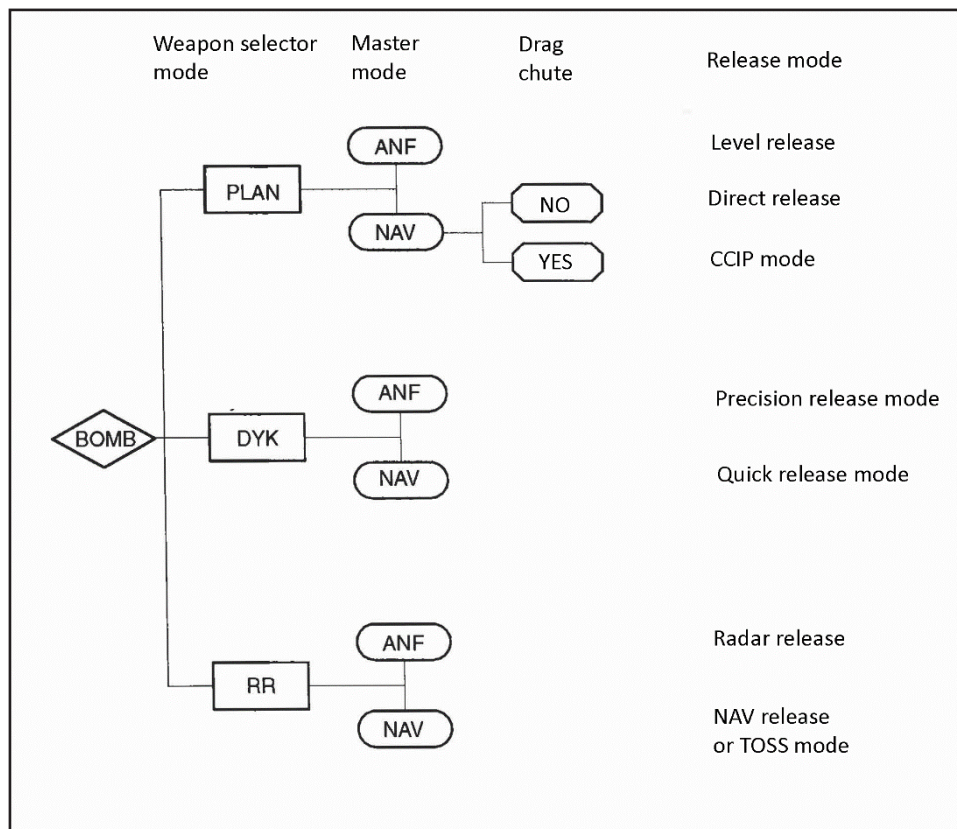

Figure 197. Bomb release modes.

Mounted in pylons of 4 bombs each. A total of 16 bombs can be carried. Bombs are mainly used for pre-planned battlefield interdictions on known targets. The bombs will be released in a single salvo with the set impact intervals.

The bombs are designed to be released from low altitude in general. They can be fitted with or without drag chutes. Drag chutes are to allow very low release altitudes so that the aircraft may leave the fragmentation area before detonation.

In general, the release calculations of the bombs are set so that the target designated will be in the middle of the bomb salvo (bombs 4 and 5 if 8 bombs are loaded, 8 and 9 if 16 bombs are loaded).

The sight mode selector can set the impact interval between 10 – 60 metres spacing.

The trigger must be held for the entire duration of the release cycle in order for all the bombs to be released.

Level (PLAN) profile

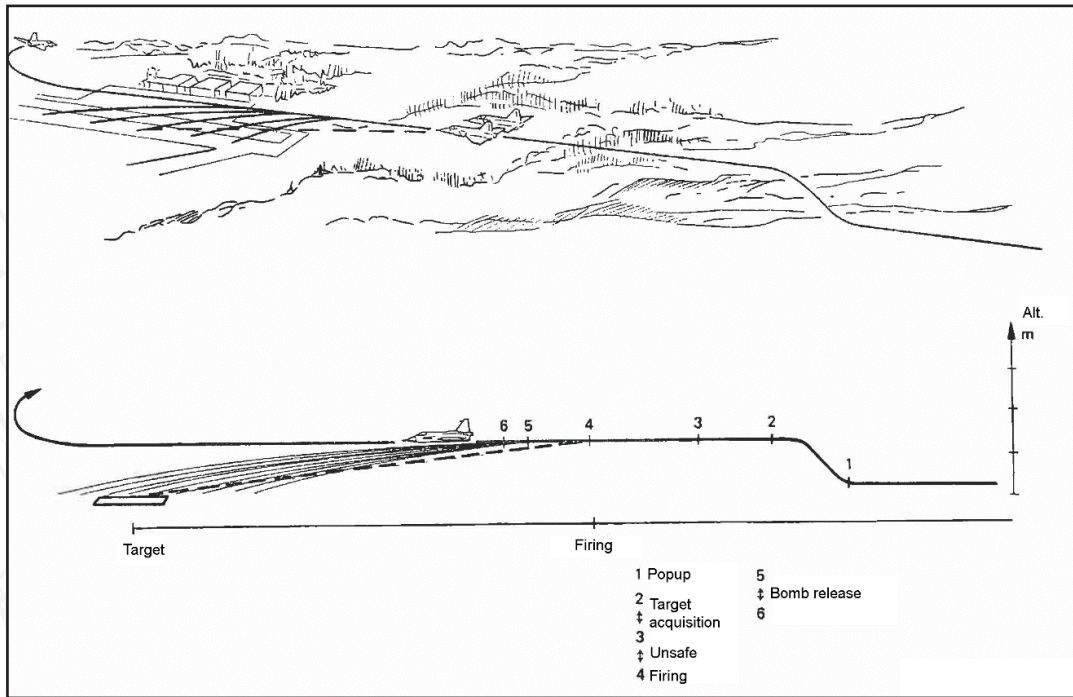

Figure 198. Level bombing profile.

Level release

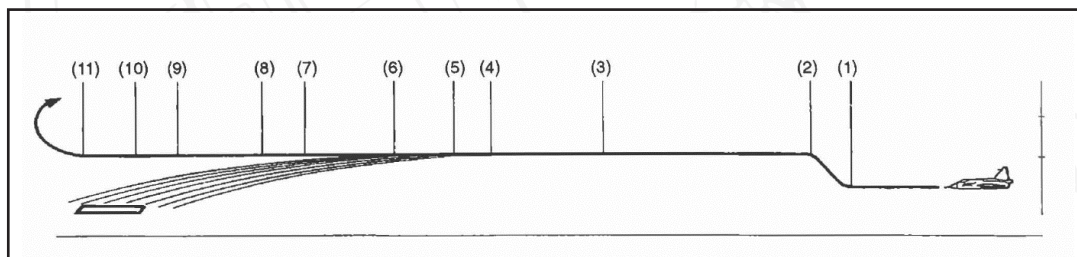
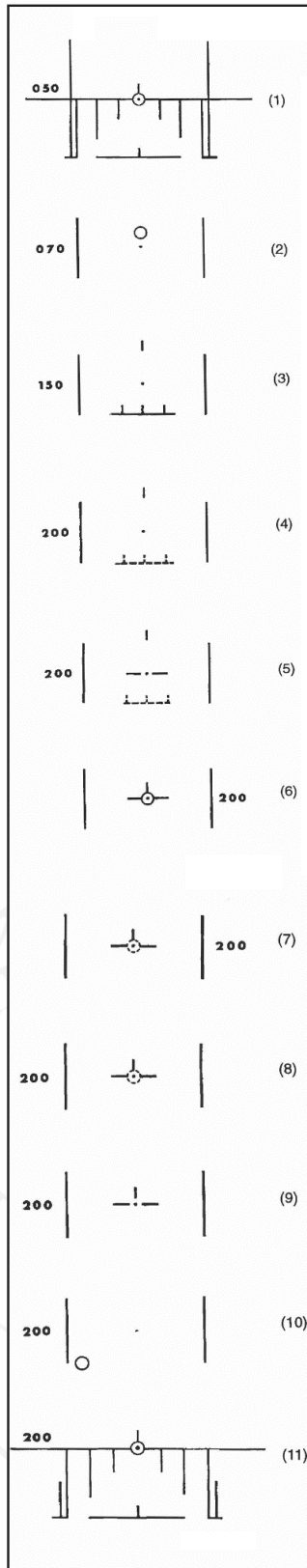

Figure 199. Level bombing phases.

Level bombing can be done in a slight climb or dive if necessary. Release altitudes is around 200 metres.

Level release HUD symbology



Mode NAV

Mode ANF. Target indicator ring on target position

Trigger UNSAFE. Target indicator ring disappears. Radar ranging used.

Firing warning. Distance flashing 2 seconds before latest release point.

Release signal. Wings appear 0.5 s before latest release point.

Trigger pulled and held. Numbers placed on the right. Ring is the steering order.

When the last release impulse is sent from the computer, steering order flashes and stores released (FÄLLD LAST) is lit. Trigger can be released. Bombs will be released when the release parameters are met. Pilot flies according to the steering order so that commanded altitude is maintained.

Steering order when the last bomb impact has been passed.

Trigger SAFE. Target indicator ring appears.

Mode NAV. Destination change automatic.

7

Level release checklist

1. Weapon selector: BOMB PLAN.
2. Sight mode selector: Desired impact intervals.
3. Set altimeter pressure (QFE).
4. Master mode: ANF.
5. Trigger: UNSAFE.
6. Fire on firing signal or when the sight disappears below the HUD.
7. Keep trigger held and fly according to the steering order ring.
8. Trigger: SAFE and master mode: NAV.

Notes.

- Radar ranging is used in mode ANF, only after trigger unsafe.
- The reticule may disappear below the HUD if the aircraft is in a slight climb, or slightly high. In that case, the pilot will have to estimate the release point.
- If the trigger is released before the stores released (FÄLLD LAST) light is lit / steering order blinks in the HUD and the release will be aborted.
- On firing in mode ANF, an automatic target fix is made on the impact point.

Direct release

Used for formation bombing when following. No sight display is used and release is made on the command of the formation leader. The NAV display will remain. The computer will release the bombs for the set impact intervals.

Master mode: NAV.

Weapon selector: BOMB PLAN.

Sight mode selector: Desired impact intervals in metres.

CCIP

The CCIP (Continuously Calculated Impact Point) mode is used when the bombs are fitted with drag chutes and in mode NAV. The reticule indicates where the first bomb in the salvo will hit if dropped “now”. The ring indicates where the last bomb in the salvo will hit. The bomb salvo will impact “between” the reticule and the ring.

A target fix is not made in CCIP mode. Only barometric altitude is used for the sight calculations and displayed in the HUD.

The distance line does not indicate distance to the target, but whether the bomb will be released within their arming time (5.2 seconds).

Selection

Weapon selector: BOMB PLAN.

Master mode selector: NAV.

NOTE: Can only be used with bombs with drag chutes attached (high-drag). With Low-drag bombs, the settings will default to the direct release mode.

CCIP HUD symbology

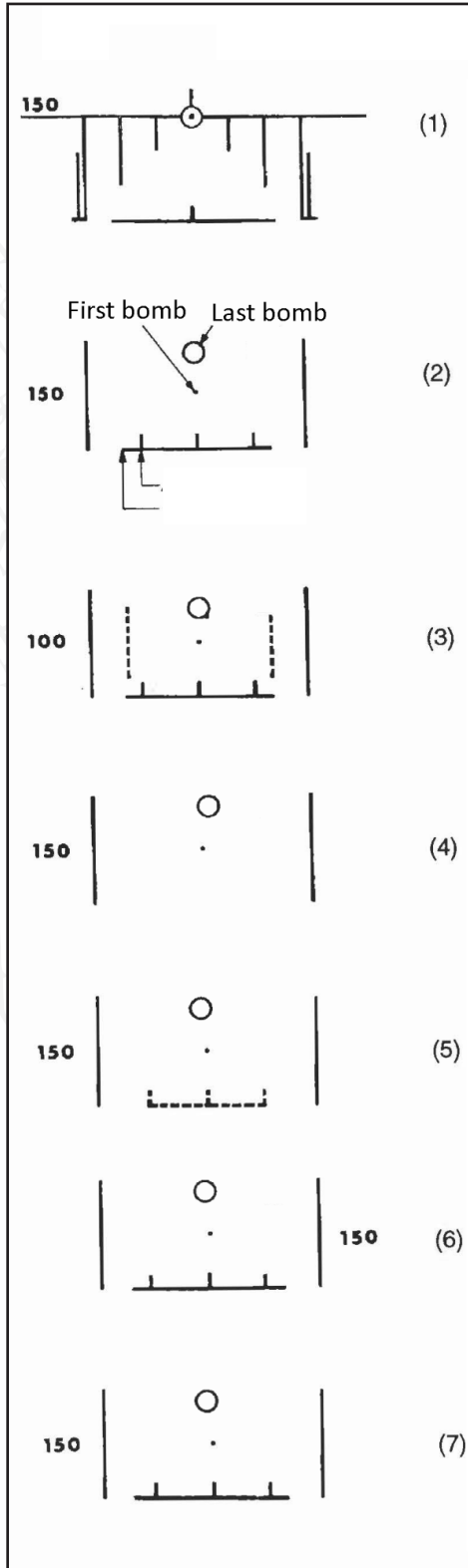

Mode NAV. Drag chutes attached.

Trigger UNSAFE. Distance line indicates arming time. Markers indicates the minimum time of fall for armed bombs.

Warning: Fragment zone

Distance line hidden.

Time of fall of bombs > maximum calculated time of fall (16 seconds)

Warning. First bomb time of fall < arming time (5.2 s)

Trigger pulled and held. Numbers placed on the right.

Mode NAV. Destination change automatic.

Dive bombing (DYK)

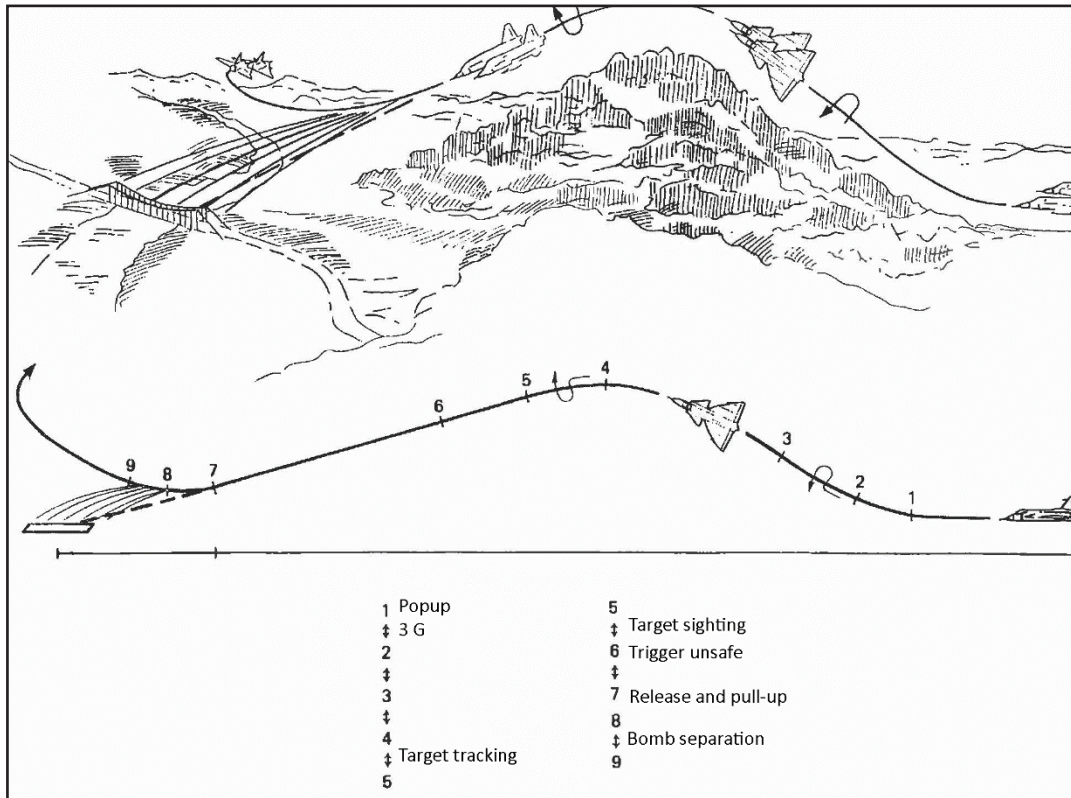

Figure 200. Dive bombing profile.

The dive bombing mode is used against point targets such as installations, troop concentrations or other softer targets. The dive mode will result in a quite precise and accurate bomb delivery method.

There are two release sub-modes:

Precision release

Sight functionality similar to AKA (A/G) / ARAK. Bombs are released when the release parameters are fulfilled on the target marked when the trigger is pulled. Target motion measurement available if enabled.

Quick release

Only ranging via triangulation. Target motion measurement and radar ranging inhibited.

Selection

Weapon selector: BOMB DYK

Sight mode selector: Desired impact intervals

Master mode selector: ANF for Precision release, NAV for quick release.

Precision mode

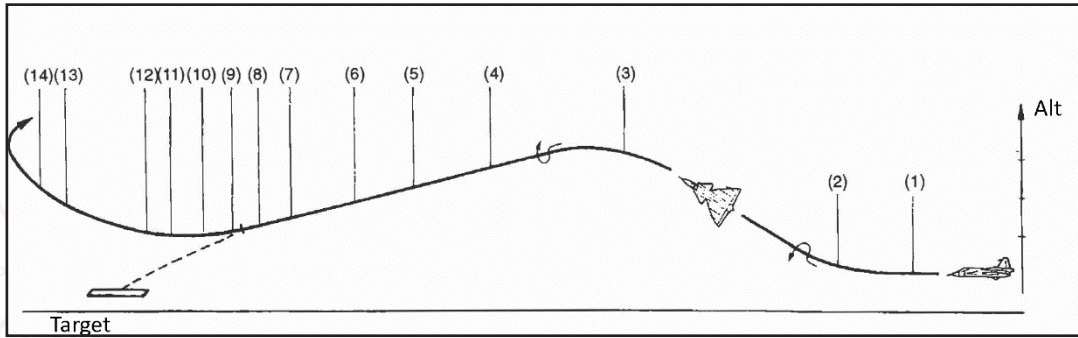
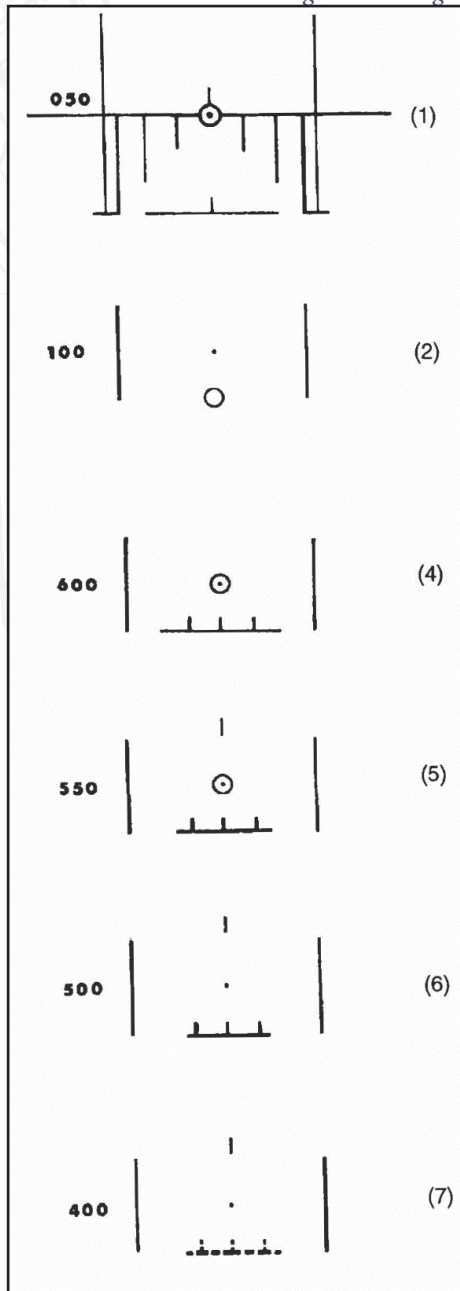

Figure 201. Figure 190 Dive bombing phases.



Mode NAV

Mode ANF. Target indicator ring on target position

Ranging via triangulation. Sight line relative to horizon $\geq 5^\circ$. Radar ranging is used if parameters are met (fin will appear).

Radar ranging used. Indicated by fin.

Trigger UNSAFE. Target indicator ring disappears.

Target motion measurement used. Doppler wind frozen.

2 seconds before the latest firing range the distance line flashes

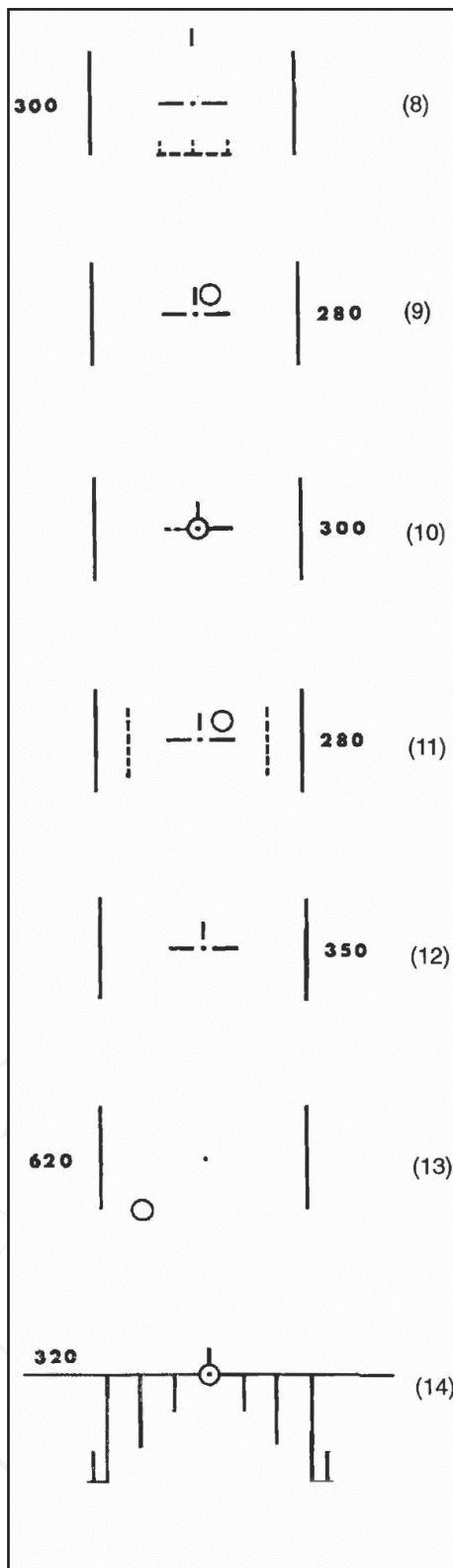

0.5 seconds before the latest firing range the firing signal is displayed (wings)

Trigger pulled and held. Numbers placed on the right.

The ring is the steering order.

The pilot should as quickly as possible make sure that the reticule follows the steering order. Computer will release bombs on the designated target when the trigger was pulsed.

Pilot has not followed the steering order properly. 2° poles flash. Take evasive action.

When the last bomb in the salvo has been released the steering order disappears, and the stores release (FÄLLD LAST) light is lit. Trigger can be released.

Trigger SAFE. Target indicator ring appears.

Mode NAV. Destination change automatic. Can also be done manually in mode ANF.

Quick release (NAV)

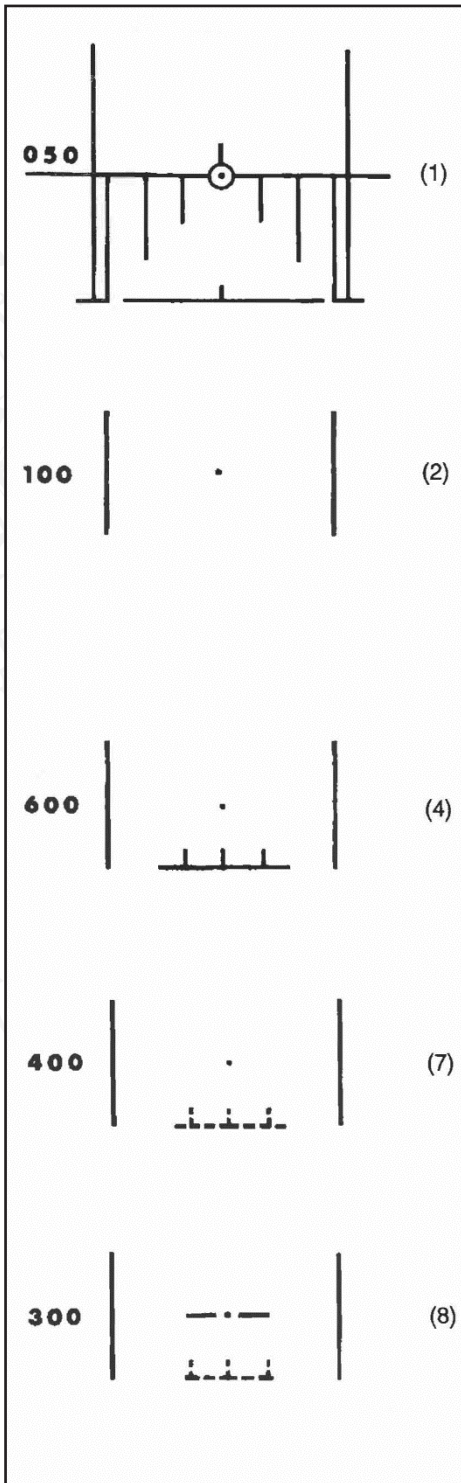

Mode NAV

Mode NAV. Trigger UNSAFE.

Ranging via triangulation. Sight line relative to the horizon $\geq 5^\circ$.

2 seconds before the latest firing range the distance line flashes.

Firing signal 0.5 seconds before latest firing range is reached.

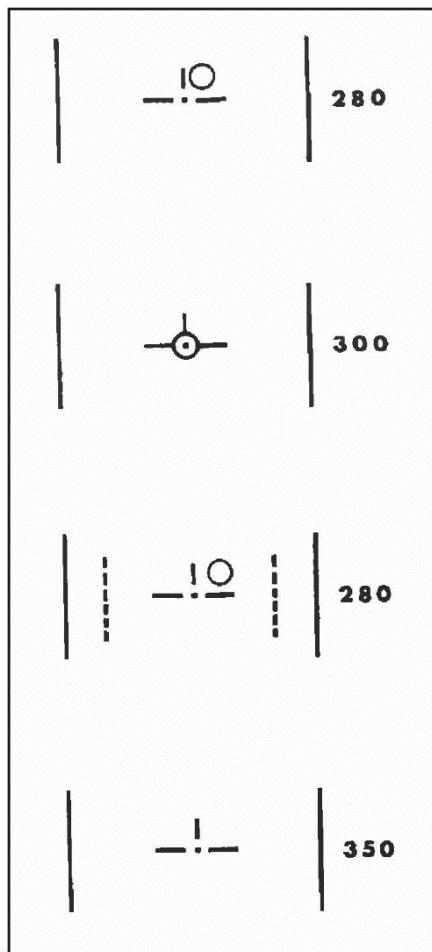

Trigger is pulled and held. Indicated by numbers placed on the right. Ring is the steering order.

The pilot should as quickly as possible make sure that the reticle follows the steering order. Computer will release bombs on the designated target when the trigger was pulled.

Pilot has not followed the steering order properly. 2° poles flash. Take evasive action.

When the last bomb in the salvo has been released the steering order disappears, and the stores release (FÄLLD LAST) light is lit. Trigger can be released.

Dive bombing checklist

1. Weapon selector: BOMB DYK.
2. Sight mode selector: Desired impact interval.
3. Set altimeter pressure (QFE)
4. Master mode: ANF.
5. Trigger: UNSAFE when the reticule is on the target and stable.
6. Fire between the earliest (flashing distance line) and latest (firing signal) range indications.
7. Keep trigger pulled. Pull up with 4 G and follow the steering order.
8. Trigger safe and select master mode NAV.

Notes.

- With master mode NAV and the trigger unsafe the “quick release” mode is obtained. Only triangulation is used for ranging. Target motion measurement is not used.
- If the steering order is not followed the safety distance is not met.
- Radar ranging is used in mode ANF, only after trigger unsafe.
- If the trigger is released before the stores released (FÄLLD LAST) light is lit / Steering order flashing, the release is aborted.

RR/ NAV / TOSS

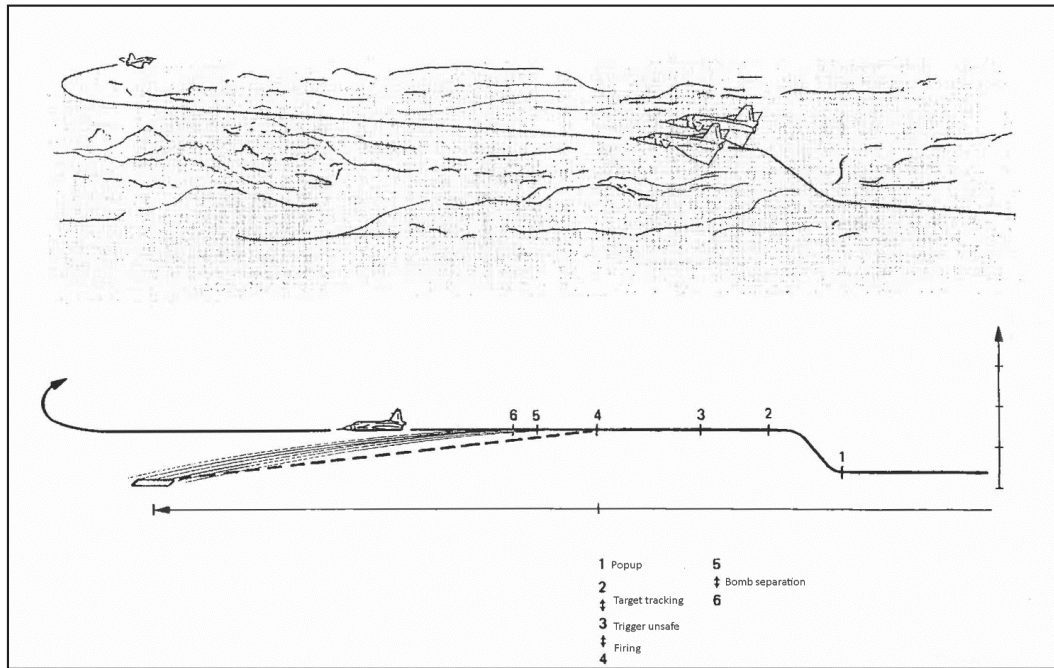

Figure 202. Radar / Navigation bombing profile.

7

Radar release can be used in adverse weather condition. Due to the relatively poor contrast of the radar against ground units, this mode has fairly little use against individual ground units, but may be used effectively on coastal and island positions, or targets with large and contrasting radar returns.

The Navigation bombing (NAV bombing) will release the bombs on the current waypoint (navigation or target waypoint). The accuracy of this mode is wholly dependent on the accuracy of the navigation system. However, it still remains a relatively inaccurate method of bomb delivery.

A sub-mode of the NAV bombing is TOSS bombing, when the bomb will be released in a sharp climb, resulting in that the bomb was “tossed”, leading to a measure of stand-off ability.

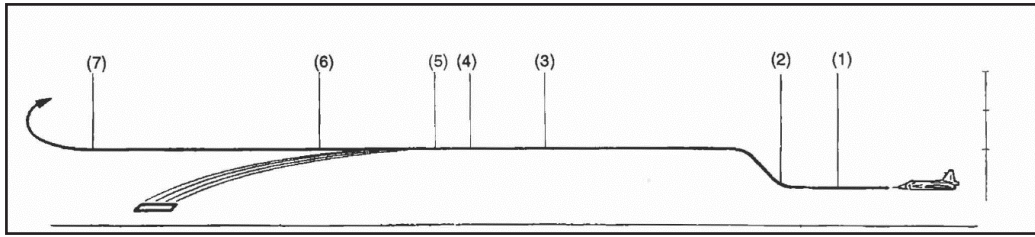
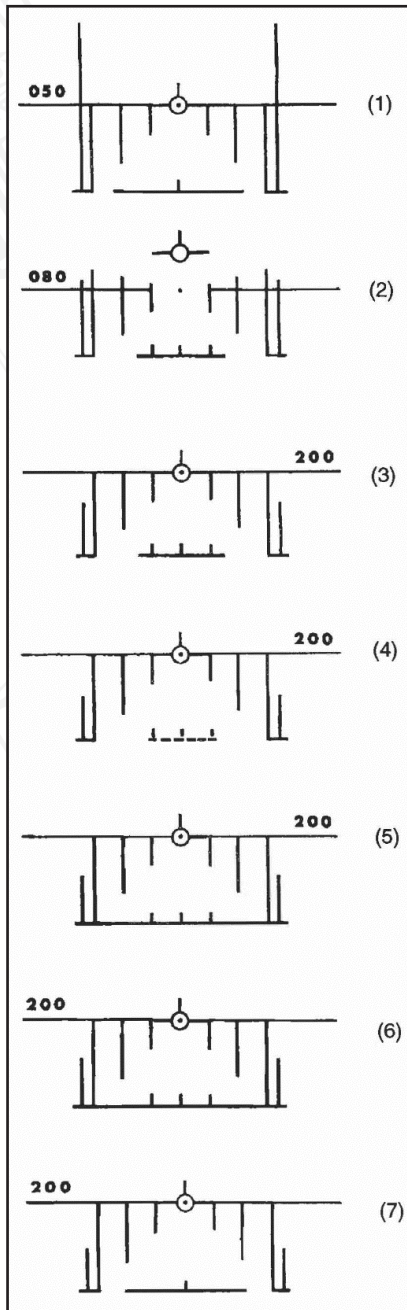

Figure 203. Radar release profile.

Radar release, HUD symbology



Mode NAV.

Mode ANF. Commanded altitude = Safety altitude.

Trigger UNSAFE.

Trigger pulled and held when the target radar return passes the firing range line at 3 km. Altitudes numbers placed on the right. Distance line starts to shrink.

2 seconds before bombs are released the distance line flashes. Trigger is still held.

Bombs release in 0.5 seconds. Distance line fully extended. Trigger still pulled but released when the stores released (FÄLLD LAST) is lit, which indicates that the last bomb has been released.

Trigger released.

Mode NAV and trigger SAFE.

Radar release, CI symbology.

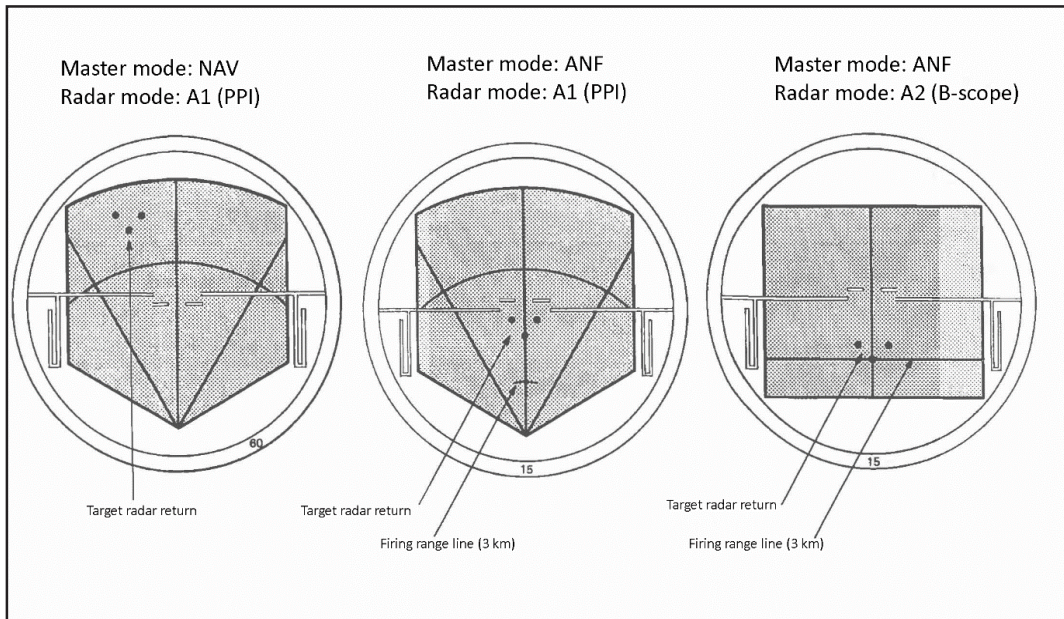
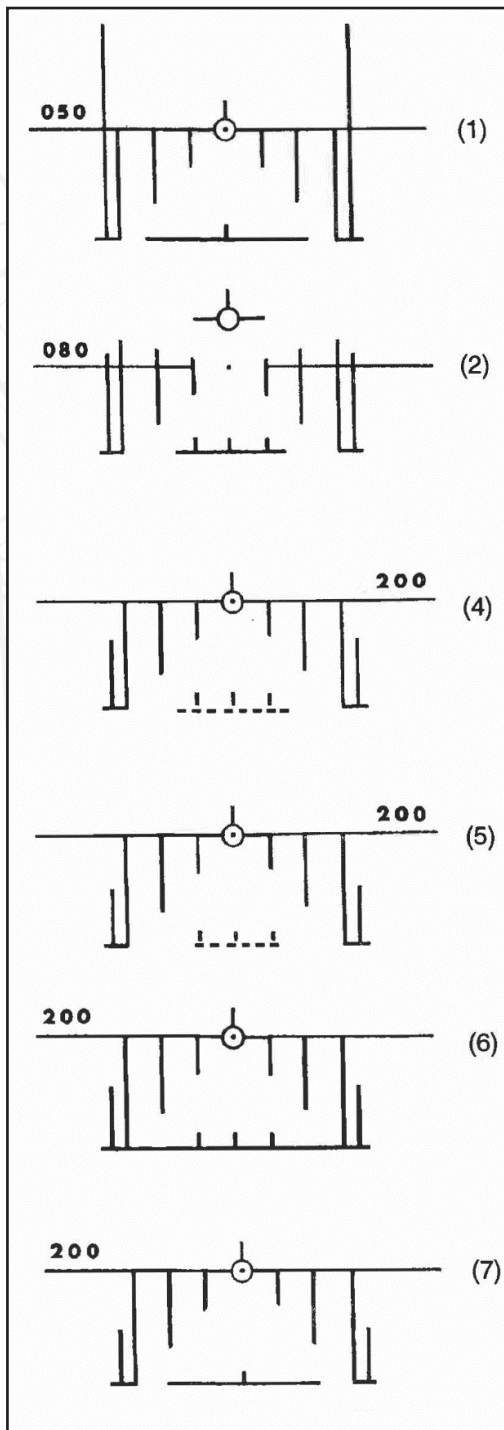

Figure 204. CI symbology for radar bombing.

NAV release mode.



(1) Mode NAV.

(2) Trigger UNSAFE. Commanded altitude = Safety altitude.

(4) 2 seconds before release, the distance line flashes.

Trigger is pulled and held.

(5) Bombs will be released in 0.5 seconds. Trigger still held, but release will be aborted if trigger is released before stores released (FÄLLD LAST) is lit.

(6) Trigger released.

(7) Trigger SAFE.

TOSS release

In TOSS mode, the pilot will have to estimate pull-up distance based on the distance indicator and the airspeed indicator. The maximum release envelope is illustrated below.

In the example below, the target is M7. The pilot makes a careful fix on B6 in order to minimise the position error in the navigation system. Careful setting of the barometric altitude (QFE) is vital.

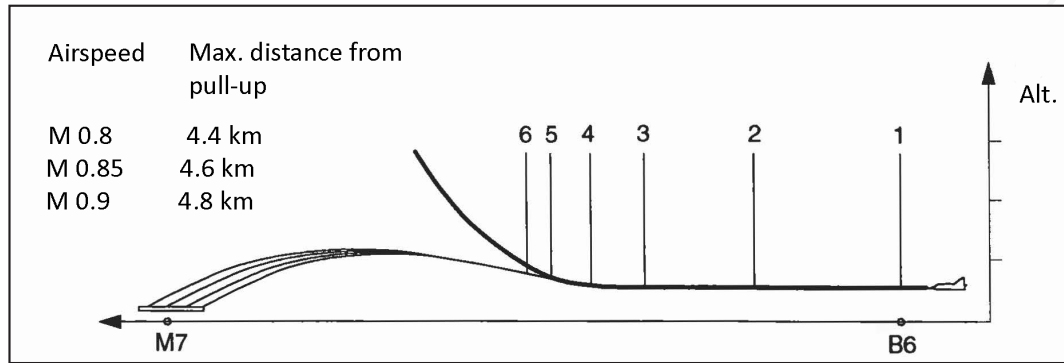
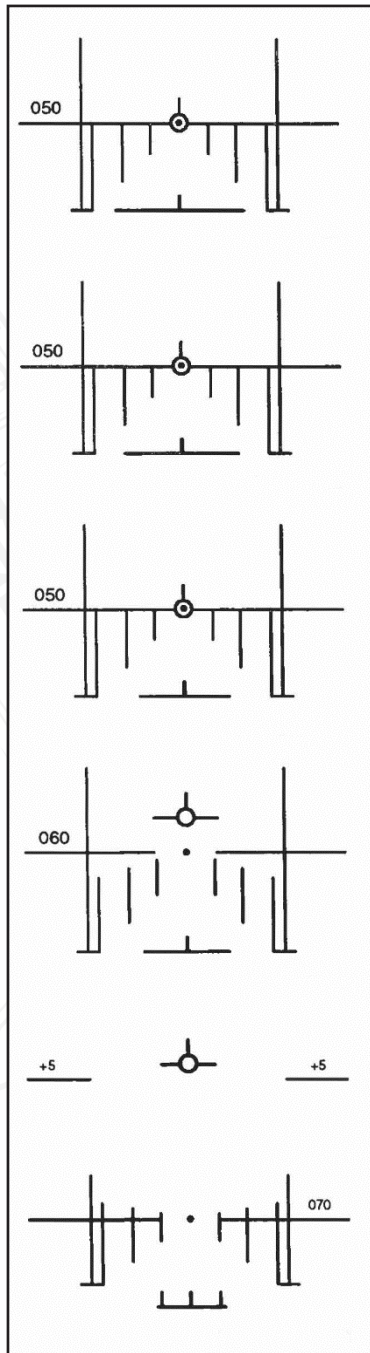

Figure 205. Toss bombing profile.

TOSS HUD symbology



Master mode NAV. Careful optical fix on a waypoint (in this example B6). Altimeter pressure is carefully set for the target area.

Flight path vector over the target (or reticule). HUD is wind compensated.

Distance indicator indicates less than maximum release range for current airspeed. (HUD distance line only indicates distance for "normal" NAV bombing).

Pull-up with 4 G.

When the climb angle is about 5° the trigger is set to UNSAFE. (UNSAFE can be set earlier)

Markers on distance line appear. Trigger is pulled and held.

At around 12- 15° climb, the bombs are released.

When the stores released light (FÄLLD LAST) is lit, the last bombs have been released and the trigger can be set to SAFE.

Radar release checklist.

1. Radar mode selector – Mode A0 (Radar off)
2. Weapon selector BOMB RR
3. Sight mode selector – Desired impact interval
4. Set altimeter pressure (QFE)
5. Master mode – ANF
6. Radar mode selector – A1 or A2
7. Fire when target radar return passes the firing range line.
8. Keep trigger pulled until the stores released FÄLLD LAST is lit.
9. Trigger safe and mode NAV.

Notes.

- With the master mode selector in mode NAV and the trigger unsafe, the NAV release mode is obtained, where the target position is determined by the current waypoint in the navigation system. Release steering is done via the HUD.
- If the trigger is released before the stores released (FÄLLD LAST) light is lit, the release is aborted.
- Commanded altitude is the set safety distance (set by crew chief when loading weapons). The pilot may fly over this altitude if desired. Higher altitudes will lead to poorer performance and may be outside of the release envelope.
- On weapons release, the radar is set to A0 automatically.

RB 05A A/G use

The RB 05A is used against single ground targets and structures such as bridges. The missile is guided via the RB05 control unit.

The missile can be selected with several different fuse settings, which is done via the weapon selector.

MARK: Ground targets. Missile will detonate just before impacting the ground / target.

SJÖ: Naval targets. Missile will detonate on impact with a very small delay.

LUFT: Aerial targets. Missile will detonate within 6 metres of an aircraft.

After the trigger is set to unsafe, the missile activates its battery. The missile has to be fired within 40 seconds or the missile will be unusable.

After firing, the missile will pull up slightly (angle of attack dependent) into view.

The RB 05 does not have a special HUD mode and only uses the NAV HUD symbology.



Figure 206. RB-05A being guided onto a target (reddish dot just left of the bunker on the island).

Guide the missile onto the target with the RB05 control unit. Attempt to keep the missile covering target. As long as the missile is superimposed over the target, it should hit. Use of autopilot attitude hold (ATT) is advised.

RB 05A checklist

1. Master mode selector: ANF.
2. Weapon selector: RB 05 MARK (Ground targets) / SJÖ (naval targets).
3. Fly towards the target either in level flight or a slight dive towards it.
4. Altitude (HÖJD) / attitude (ATT) autopilot modes: if desired.
5. When within 10 km of the target, trigger: UNSAFE.
6. Fire the missile. Steer the missile onto the target.
7. After impact, trigger: SAFE and evade.
8. Master mode: NAV.

Notes.

- Trigger UNSAFE should not be done before target is spotted as the battery in the missile only lasts for 40 seconds.
- If the trigger is set from UNSAFE to SAFE, the next missile is automatically selected.
- The missile can also be fired in mode NAV.

RB 75 (AGM 65)



Figure 207. EP-13 sight.

The RB 75 is used against ground targets such as armour, soft targets. The missile will track its locked target automatically and does not require pilot input after being fired. The missile can even track a moving target.

The HUD will display the boresight angle of the missile. The missile itself is aimed by using the EP-13 sight to the right of the HUD.

The missile has a field of view of 5° and a total slewable cone of 30° . The missile can be fired within a cone of 15° from the centre.

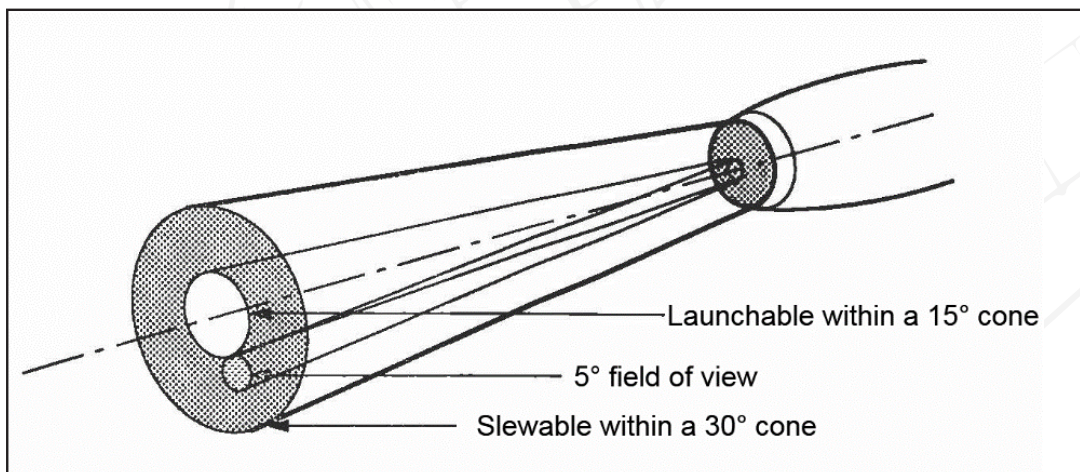

Figure 208. Maverick seeker limits.

Locking and slewing the missiles seeker is done with radar control stick. The radar mode selector (A0, A1, and A2) will select different contrast modes. The movement of the radar stick itself is used to slew the missile once unlocked and slewable (fix trigger = T1)

A0: Black on white.

A1: White on black.

A2: Automatic selection.

The fix trigger will select the lock mode.

T0: Missile boresighted.

T1 (first detent): Missile seeker slewable.

TV (Second detent): Missile lock.

The contrast and brightness of the sight can be adjusted on the dials on the left vertical side panel labelled EP13 KONTAST (contrast) and LJUS (brightness)

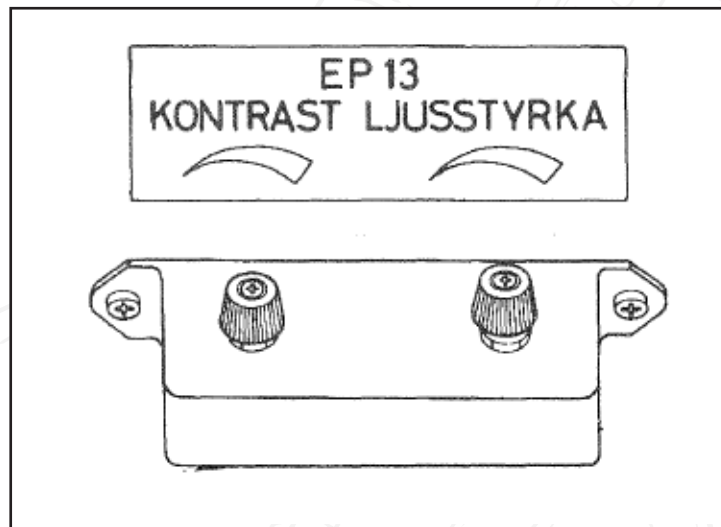

Figure 209. EP-13 controls.

Rb75 checklist

1. Weapon selector: RB 75.
2. Set altimeter pressure (QFE)
3. Master mode selector: NAV.
4. Point the aircraft at the target with the HUD reticule.
5. Radar mode selector: Select Rb75 mode (**A0**: Black on white, **A1**: White on black, **A2**: auto).
6. Pull the fix trigger to the first detent (T0 – T1).
7. Move the crosshairs in the EP-13 sight onto the target by using the radar control stick.
8. Lock the target by pulling the fix trigger to the second detent (TV).
9. Trigger: UNSAFE, and fire on stable target lock.
10. Trigger: SAFE and evade.
11. Master mode: NAV or commence re-attack.

Notes.

- The missile can be bore sighted by releasing the fix trigger (T1 – T0) or setting the trigger to SAFE – UNSAFE
- The next missile is selected by setting the trigger to UNSAFE – SAFE or by pressing the next missile button IR-RB FRAMSTEGNING on the left vertical side panel.
- The missile can also be used in master mode NAV. The missile seeker and display will activate when the trigger is set to UNSAFE.

Illumination bomb Lysbomb (LysB) 80kg

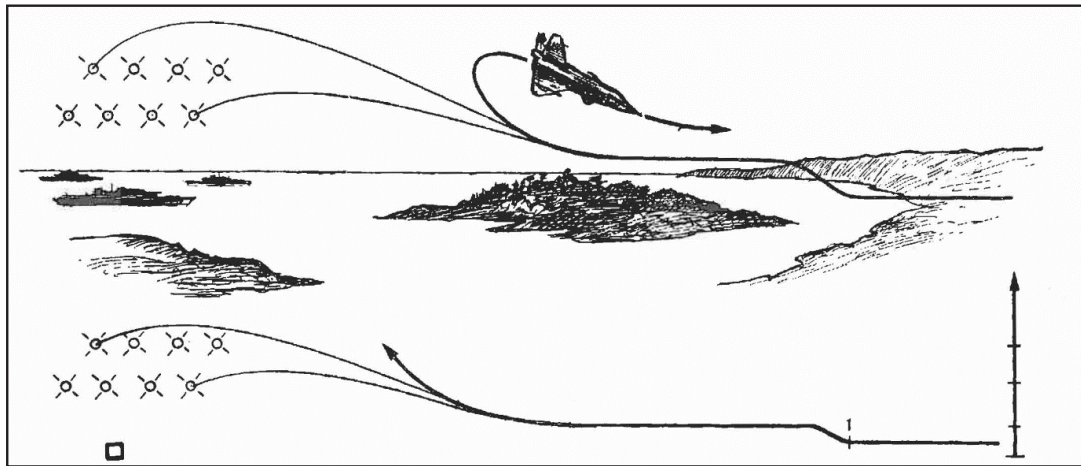

Figure 210. Illumination bombs profile.

The illumination bomb will deploy a 3 million candela flare over / near the target and illuminate it in order to allow other aircraft to engage at night. The aircraft can carry up to 8 bombs using the same bomb rack as the M/71 high explosive bombs.

Illumination bombs can be released either in ANF or NAV (after trigger unsafe).

7

The sight mode selector is used to set the flare offset. In the case the pilot does not want flares on top of the target, the row of flares can be placed left or right of the target with a pre-set offset distance (1,2,3 km).

RAKT: Flares will be placed on top of the target

VÄ: Flares offset left of the target with the pre-set offset distance

HÖ: Flares offset left of the target with the pre-set offset distance

Offset distance is set by mode TAKT / IN on address 23 with either value 1, 2, or 3, which corresponds to 1, 2 or 3 km. Confirm input by pressing LS.

Value 0 or clearing in mode TAKT results in the default 2 km offset.

Illumination bomb HUD display

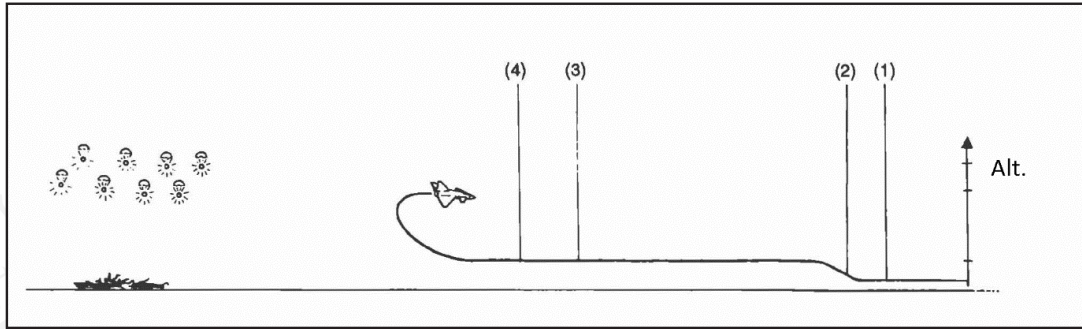
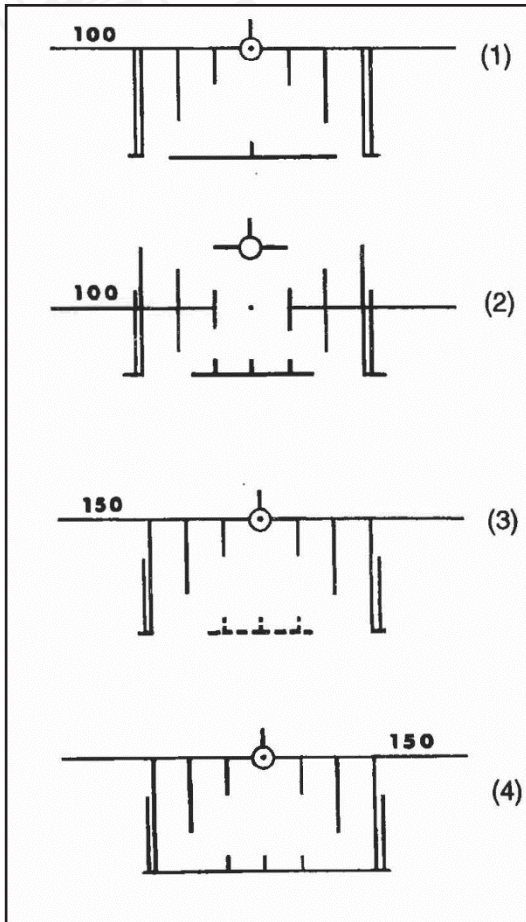

Figure 211. Illumination bomb attack phases



Master mode NAV.

Master mode ANF or NAV. Commanded altitude 150 m.

Distance line flashes 4 seconds before pull-up point. Trigger is pulled and held. It is assumed that the attack is done at a constant M 0.9 with afterburner zone 1.

(Note. This is not the same pop-up point as the one inputted in TAKT)

Pull-up point is passed in 1 s. Pull-up should be made with 4 G and fly according to the ADI flight director needles. Maintain 4 G and keep trigger pulled until the FÄLLD LAST light is lit. Bombs are released when the conditions for release are met.

Radar release

The radar target fix in illumination bomb mode is a normal target fix, but the offset distance will automatically be added (if sight mode selector is set to Left or Right). If the sight mode selector is set to RAKT, no offset will be used. Steering commands to the offset point is shown of the HUD and the ADI.

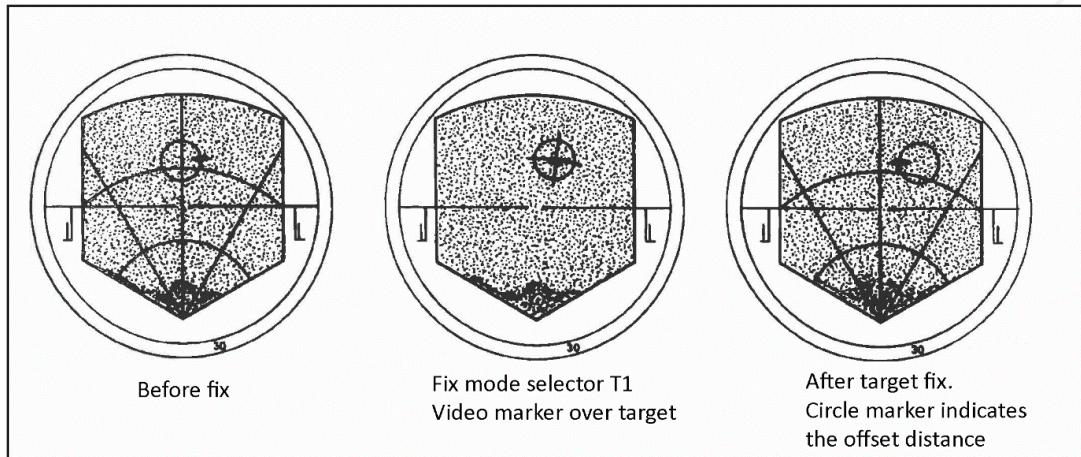

Figure 212. CI symbology for illumination bombs.

Illumination bombs checklist

1. Weapon selector: mode ATTACK
2. Sight mode selector: desired position of flares. VÄ: left, RAKT: on top of target, HÖ: right of target.
3. Set altimeter pressure and master mode: ANF.
4. Trigger: UNSAFE.
5. Fire when the distance line flashes (2 seconds before pull-up).
6. Pull up with 4 G and follow steering commands on the ADI flight director needles.
7. Keep trigger pulled until the stores released light (FÄLLD LAST) is lit.
8. Set trigger to SAFE and master mode: NAV.

Notes.

- With master mode selector in mode NAV and trigger unsafe, the same HUD display as in mode ANF appears.
- If the trigger is released before the FÄLLD LAST light is lit, the release is aborted.
- Release can be made with all waypoint types.
- If using a radar target fix on a target waypoint, an illumination bomb fix is made. The fix is offset with the pre-set offset distance and direction.

RB 04E

The RB 04E anti-ship missile is designed to be used either against individual ships or groups of ships such as transports or landing craft. The missile can be released between 50 – 425 metres altitude.

The AJS-37 can carry a maximum of two RB 04 missiles on the inner wing pylons, and they can be released in either impulse (single) or series (both missiles at the same time). When released in series the missiles will separate slightly and ignite the rockets with a delay. The second missile is released 2 seconds after the first.

Upon release, the missile will descend to 10 metres altitude and fly towards the target area.

The seeker head on the missile is a monopulse radar and can be set to either target single radar contacts or grouped targets (assumed to be transports or landing craft). The missile's radar has a range of approximately 8 kilometres and a width of $\pm 28^\circ$.

The missiles can be fired in two main modes, either Single target mode, designed for smaller formations or single targets or Group mode, designed for countering large formations of ships.

In group mode, the missiles can be pre-programmed on the ground to be assigned to specific rows in a larger convoy formation (such as missiles selecting the second "column" of ships).

Due to the nature of the missile seeker, it is strongly recommended to attack in a wide formation, and preferably from multiple angles to prevent multiple missiles hitting the same ship.

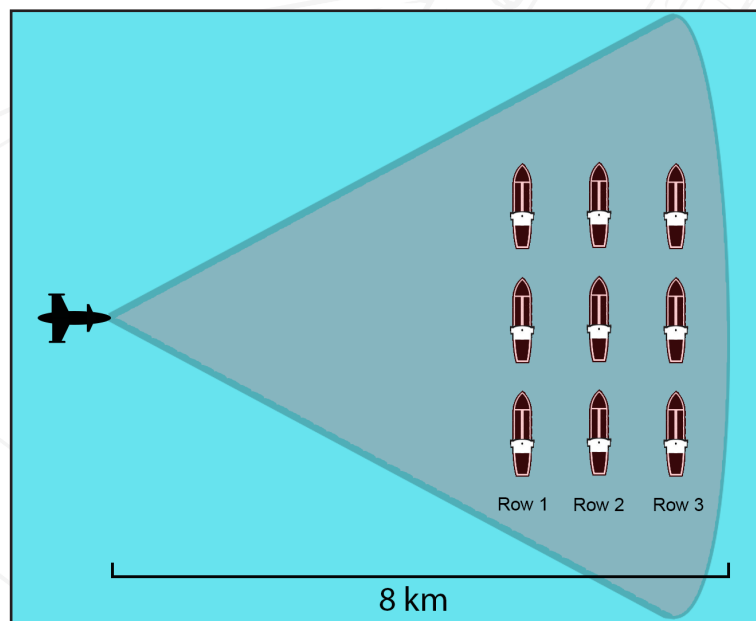

Figure 213. Row selection (GROUP mode only)

For information on how to set up the "on ground" seeker presets, please refer to the "I Mission Editor Settings" section of the Appendix.

Group Target section

Grouped target mode is selected by setting the targeting mode selector to GRUPP (Group-mode). In this mode, the missile will select two or more contacts that constitute a "group". The prerequisites for a "group" are that two or more contacts must be within 2700 metres of each other in depth. If unable to determine a group, the missile may ignore the targets entirely. Therefore it is imperative that the targets can be determined to be a "group" before the missile is fired in GRUPP mode. If this is not the case, the ENKEL (Single target mode) is suggested. In this case, the first target found by the radar will be locked on.

If the missile detects a grouped target, it will select one of the contacts according the pre-set row assignment or random, leading to multiple missiles selecting different targets.

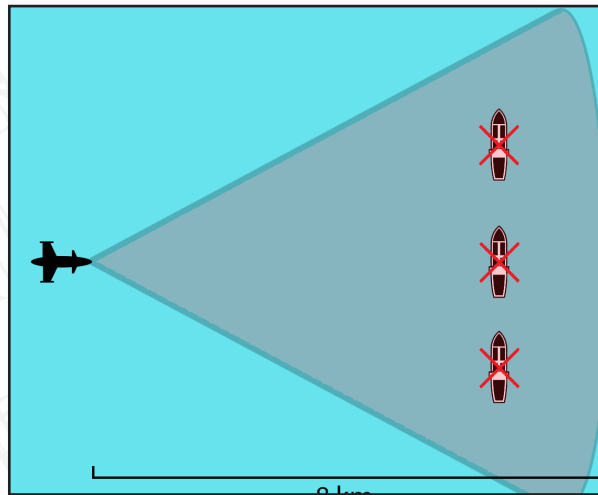

Figure 214. Case 1, Group not found

In the case above, the missile is unable to determine a group, and will therefore continue to fly until it either finds a suitable group or crashes due to lack of kinetic energy.

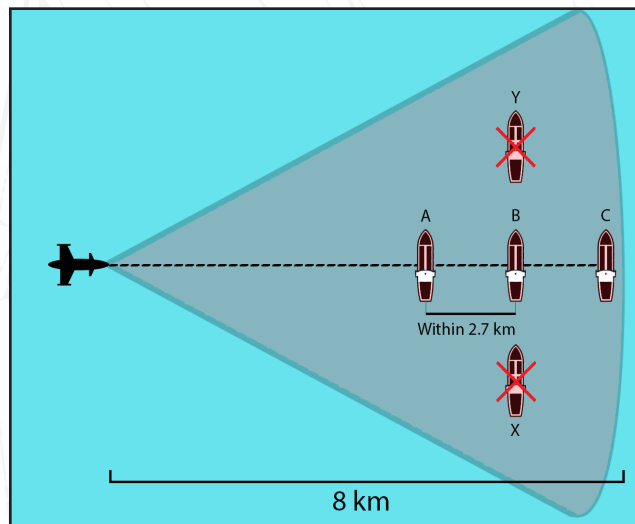

Figure 215. Case 2, Group found

In case 2, the missile approaches the formation from the "beam" and detects a group of ships (A,B, and C) that are within 2.7 km of each other. Ships A and B constitute a group on their own, however the third ship will be included in that group. With this beam aspect onto the formation, ship A becomes row 1, ship B becomes row 2 and so on.

The missiles will then select the targets according to the pre-programmet setting. If the missile would be launched from ahead of the ships (from the top in the picture above), ships Y, B, X would be the group instead. Therefore, plan your attacks on formations accordingly."

HUD and CI display

The HUD display is the normal navigation display. The distance line indicates range to the current waypoint.

The markers on the line indicates the maximum release distance. At minimum release distance the line flashes. The distance line appears when 40 seconds remain until the maximum recommended release distance. The commanded altitude is set to 240 metres.

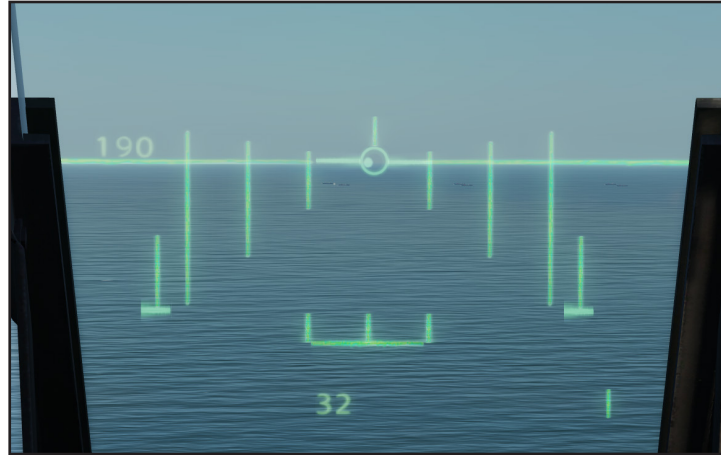

Figure 216. RB-04E and HUD ranging information. Missile within recommended launch range

The CI display is a radar display adjusted for drift due to wind. The previous centreline is now a track adjusted due to wind. Extra markers are displayed to indicate the 24 and 12 kilometres.

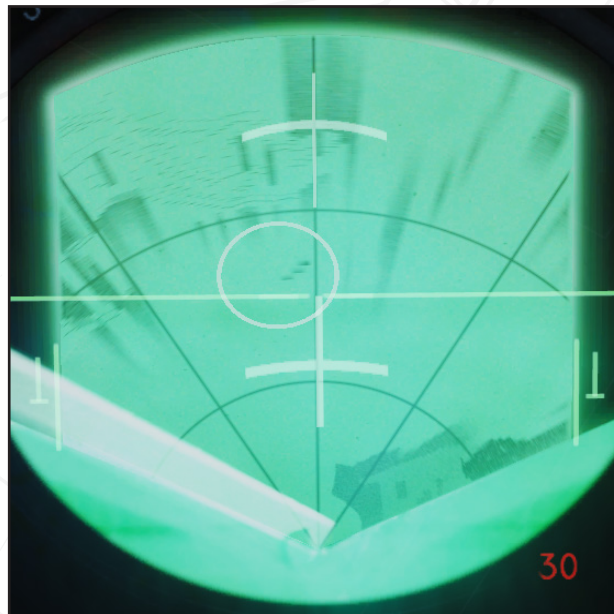

Figure 217. CI symbology for RB-04.

If the aircraft is outside of the release envelope and trigger is UNSAFE, the altitude warning light is lit with a solid light.

The stores released indicator light (FÄLLD LAST) is lit when in impulse a missile is successfully released or in series when both are released. The light is reset when the trigger is set to SAFE or another missile is released.

RB 04E checklist

1. Weapon selector: mode ATTACK.
2. Release mode selector: desired mode. Impulse (single) or Series (both).
3. Set altimeter pressure (QFE).
4. Master mode selector: Mode ANF (or NAV).
5. Use the radar to find the target, make a target fix and aim towards the target. (On visual aiming, put the flight path vector on the target).
6. Targeting mode selector: desired position. Group (GRUPP) or single targets (ENKEL).
7. Fly to either commanded altitude or within the allowed release envelope (50 – 425 m), and if desired engage either attitude or altitude hold.
8. Trigger UNSAFE and release within the release range.
9. Evade, trigger SAFE and master mode NAV.

Notes.

- RB 04 can also be released in master mode NAV or SPA, but with no range information on HUD and CI and no wind drift compensated display on CI.
- If trigger is set to safe before the stores released (FÄLLD LAST) is lit, there is a risk that the missile will not be released.
- Release with seeker in group mode (GRUPP) can only be made if the targets are grouped in the depth axis.
- On missile release a relatively forceful trim change in roll occurs, which is easily countered by stick input. With the attitude / altitude hold function enabled this trim change is dampened and negligible.

RB 15F

The RB 15F is a modern anti-ship missile intended for all types of naval target. It has a sophisticated seeker system and features a programmable navigation system. The missile is released from an altitude between 50 – 2000 m. Missiles can be released either in impulse (single) or series.

Programming the missile guidance system can be done via the data panel with coordinates, or by use of the radar fix system. The guidance system uses a series of waypoints (Bx6-9) for navigation. Additionally, certain features of the missiles guidance and the target selection can be made via the data panel using addressed data in mode TAKT.

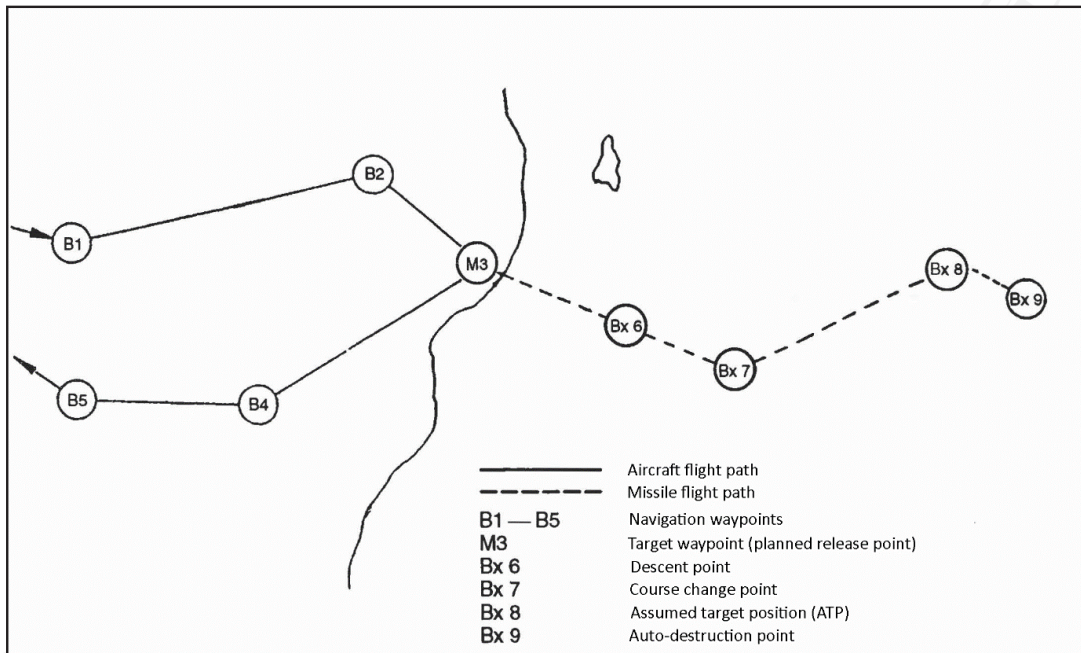

Figure 218. RB-15F Flight plan and waypoints.

Bx6 is the descent point where the missile descends from the release altitude and is dependent of the distance to BX7. Note that the BX6 point is not a waypoint as such, but the point from BX7 where the missile will descend, as seen below on the flight path.

Bx 7 is the course change point.

Bx 8 is the assumed target position (ATP).

Bx 9 is the self-destruct point

For information how to set up the BX points in the Mission Editor, please refer to the "I Mission Editor Settings" Appendix

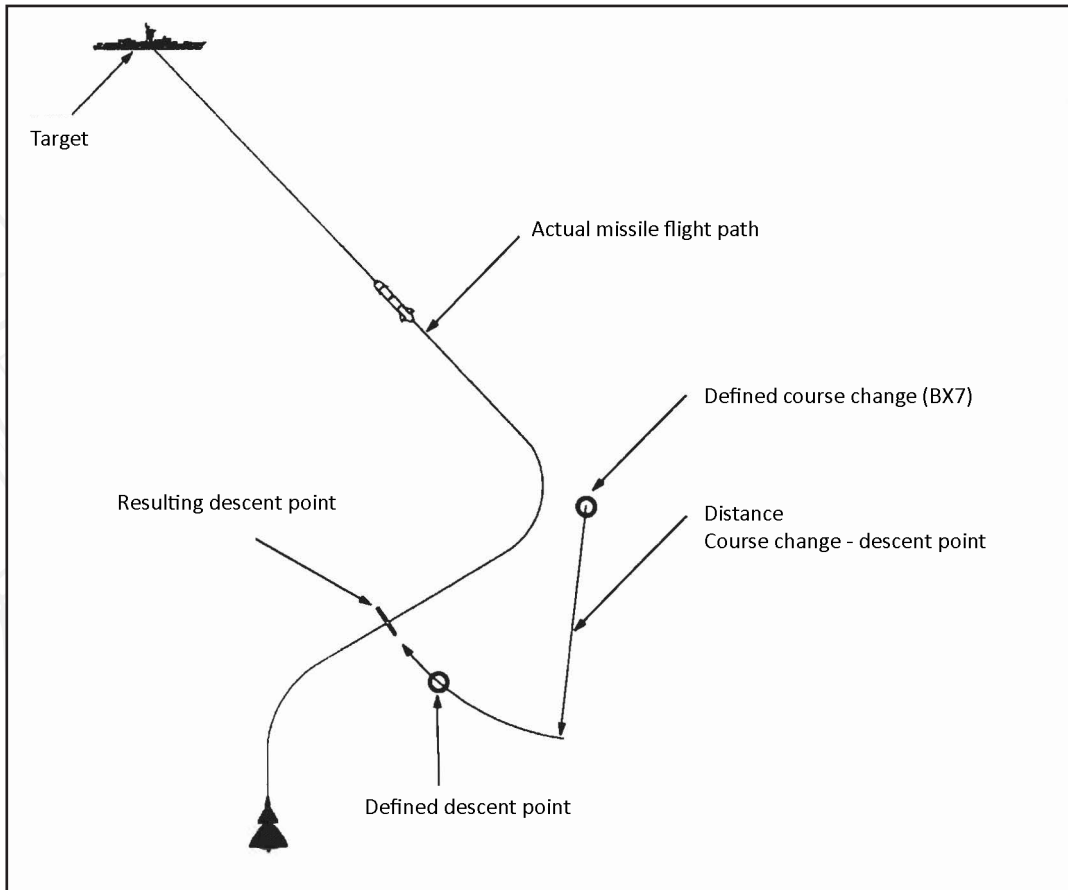

Figure 219. Actual missile flight path

Targeting mode selector

The RB 15 can be released in a number of different modes.

In Master mode ANF and Weapon selector in mode ATTACK the missile is prepared with waypoints from the navigation system (Bx6-9). Further entered information such as wind is loaded into the missile's memory.

The targeting mode selector switch (VALB / STD) is used to toggle two alternative presets in the missile preparation data. Entered route is not affected by the switch. The selector has no function if missile is released in mode NAV / SPA.

VALB (Selectable): Missile guidance and seeker programmed with values in addresses 81-88 that the pilot has set.

STD (Standard): Missile guidance and seeker programmed with standard values. Missile will search for targets near the ATP and lock the target closest to the ATP (Area / Single target mode).

QUICK MODE: If the trigger is set to UNSAFE in mode NAV or SPA, the "Quick" release mode is selected. In this mode the missile is released and will immediately start searching for targets within the $\pm 35^\circ$ radar cone, between 2 and 20km forwards. The first target detected will be locked.

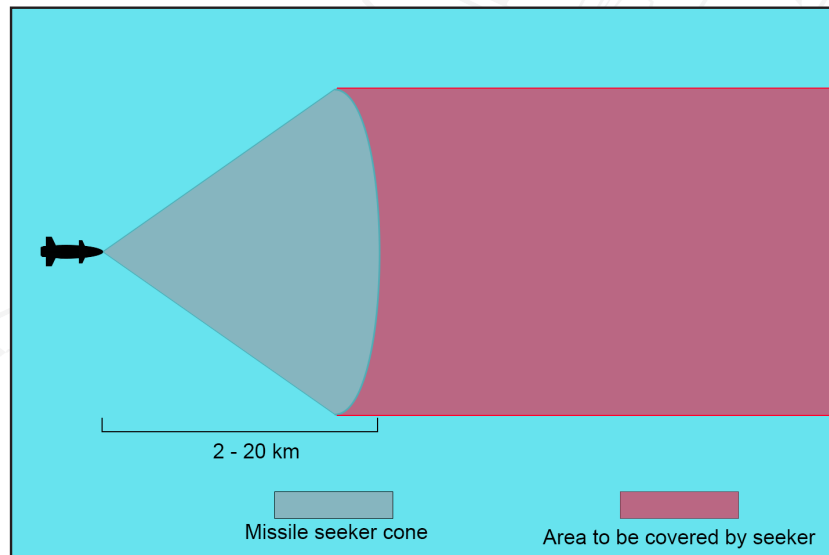

Figure 220. RB15 Quick mode.

Release mode selector

IMPULS (impulse) – Selected missile will be programmed with the data and launched.

SERIE (series) – Both missiles will be programmed and launched. The second will be launched 2 seconds after the first.

Coordinates Input

Input of BX coordinates can be made via inputting the coordinates via the data panel (same as inputting mark points Bx1-5). Bx8 must always be entered. If Bx6, 7, and 9 have not been defined, they will automatically be placed if in Master mode ANF by a standard pattern. Waypoints defined in this manner are displayed in the same manner as manually entered points.

It is possible at all times to define any of the waypoints via inputting coordinates or by taking fixes.

Timekeeping function

It is possible to define a time on target for the missile in mode TID/IN. This is the time when the missile reaches the target area. Input time and confirm by pressing waypoint button BX.

The following parameters are calculated in order to achieve the correct release time.

- Release position coordinates: Normally the first target waypoint in the navigation polygon.
- Release speed: Entered ingress speed when reaching the target waypoint.
- Release course: The heading of the leg towards the target waypoint.
- Release altitude

The calculated time of flight is used for the timekeeping in modes BER and NAV, so that the aircraft arrives at the correct time for release so that the missile will reach the target at the set time on target.

In other words, the time on target cues are adjusted so the aircraft reaches the release point at the correct time to be able to coordinate missile impacts with different release distances and angles, instead of the time when the aircraft reaches the target point as in other weapons modes. Time keeping is displayed as normal on the HUD with the airspeed deviation fin and in the data panel in mode TID/ OUT.

Release and descent

On release the missile maintains its release altitude until the descent.

On reaching the descent point, the missile will descend to the relevant altitude dependent on the position of the missile in the flight profile and the programmed data.

Flight over land: 80 m AGL, or release altitude (if released below 80m) – 20 m (minimum of 10m AGL).

Flight over sea: 30 metres.

Search altitude: 10, 15 or 30 metres dependent on search mode.

Sea-skimming: Selected by default via the TAKT input. Missile will fly at the lowest possible altitude.

Seeker modes

AREA search

Used when the target position (ATP) is known. The missile will search within an area near the ATP. Size of the area can be pre-set via the addressed data in four categories, precision, small, medium and large.

Search altitude of the missile is dependent on the set area size. If the distance to the ATP is less than 2 km, mode CLOSE is automatically engaged.

BEARING

Used when only the bearing to target is known. Radar will sweep in an increasing arc from a narrow search up to $\pm 35^\circ$. Search range is about 6- 24 km.

Search altitude is always 30 metres.

CLOSE

Similar to BEARING, but with reduced range (2- 20km). Seeker will lock on the first detected target.

Target passage

If the missile for some reason does not impact the target in any mode, the missile will automatically search for a new target in front of it in mode CLOSE until it reaches the self-destruction point (BX9) or the missile loses energy.

Search mode boundaries

The seeker search sweep can be limited sideways by inputting data. The entered lines are set in distance left or right of the missile's search centreline in whole kilometres (1 - 15). Boundary lines are parallel to the centreline and is used to electronically block contact outside of this line.

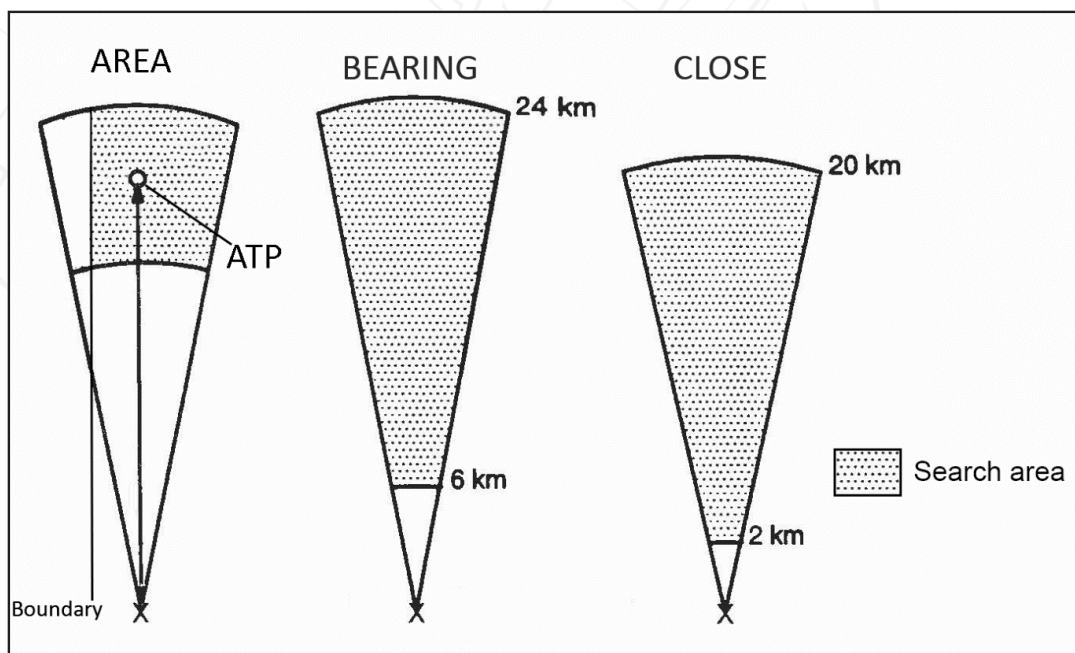

Figure 221. RB-15F seeker modes.

Target selection

Single target

The missile will lock the target closest to the ATP in mode AREA. If in mode BEARING the target closest to the search centreline is selected.

Multiple targets (N)

Missile will at random select one of the three targets closest to the ATP.

Multiple targets (A)

Missile will at random select any of the detected targets.

Group targets

Missile will determine a group of ships that are within 3 km of each other. From this group, a target is selected at random.

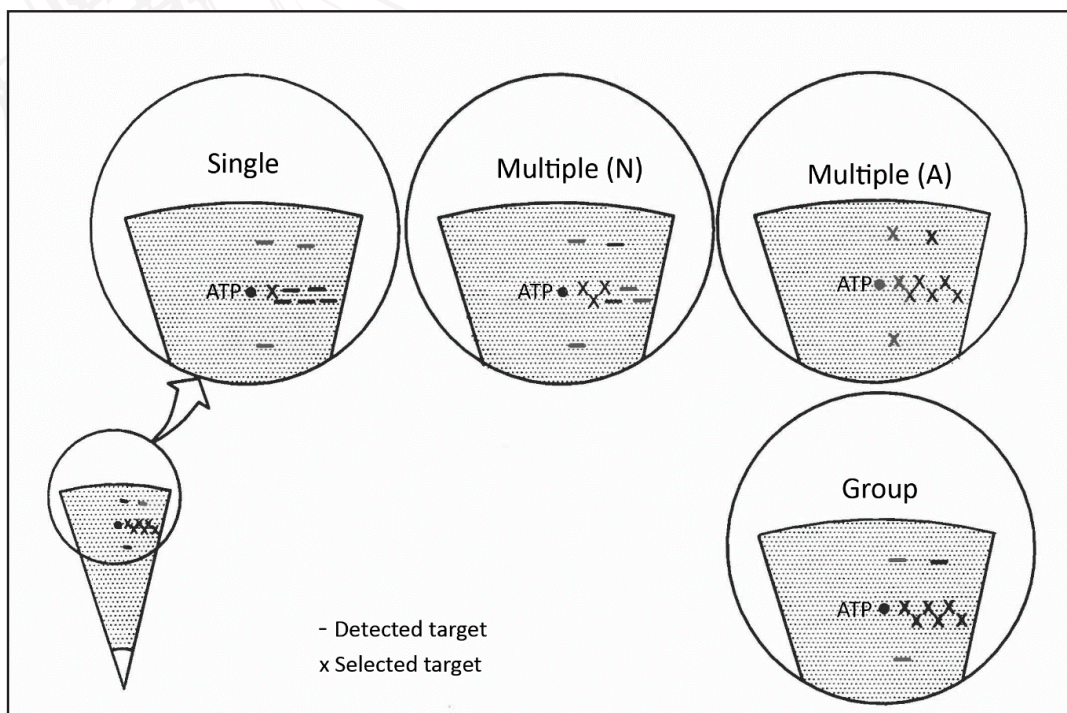

Figure 222. RB-15 target selection modes.

Homing

After the target is detected, and selected, the missile will home onto the target. The missile can either fly towards its target at 10 metres altitude or sea skimming (target approach)

Self-destruct

After the missile has passed the target without impact and finding no target, it will fly towards the last waypoint (BX9), where the missile will self-destruct if the missile is still flying. The BX9 waypoint is optional and is mostly used for preventing the missile from hitting unintended targets.

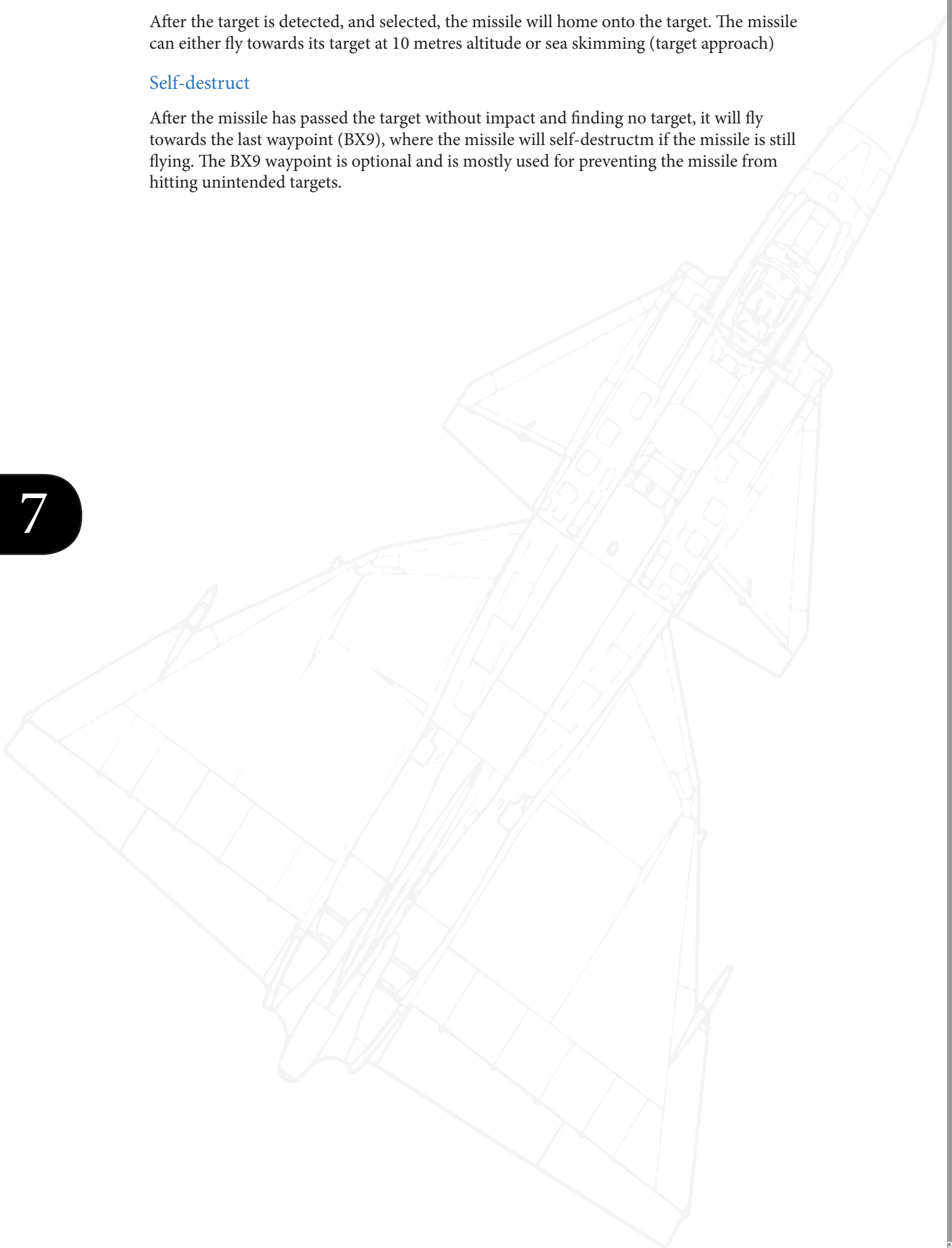

Missile programming

Address 80 is used for setting master pre-sets that overrides the inputs on addresses 81-86.

Value 0000 (800000): Master reset, will reset all values on addresses 81-86 to standard values.

Below are series of missile pre-set profiles:

0000 (80000, or STD on targeting selector switch) Single target, large search area.

0001 (800001): Confined area attack. Multiple targets N, medium area search.

0002 (800002): Unconfined area attack. Multiple targets A, medium area search.

0003 (800003): Convoy attack. Group target, large area search.

0004 (800004): Bearing attack. Bearing search mode.

*Standard value (STD) in bold / Light gray.

<i>Address 81 (std 810111)</i>	0	1
Single target (STD)	Yes	No
Multiple target N	Yes	No
Multiple target A	Yes	No
Group target	Yes	No
<i>Address 82 (std 820000) [No function]</i>	0	1
[No function]	Yes	No
[No function]	Yes	No
[No function]	Yes	No
[No function]	Yes	No
<i>Address 83 (std 830000)</i>	0	1
Altitude after descent point (Bx6) sea skimming (STD)	Yes	No
(No = 30 m ASL)		
AREA search	Yes	No
No = BEARING		
[No function]	Yes	No
[No function]	Yes	No
<i>Address 84 (std 841110)</i>	0	1
Precise search area	Yes	No
Small search area	Yes	No
Medium search area	Yes	No
Large search area	Yes	No

Address 85 (std 851100)	0	1
Boundary line left	Yes	No
Boundary line right	Yes	No
Distance 01 – 15km (2 digits)	-	-
Address 86 (std 861000)	0	1
Target approach 10m ASL (no = sea skimming)	Yes	No
[No function]	Yes	No
[No function]	Yes	No
[No function]	Yes	No
Address 87	-	-
Wind direction* in target area 000- 360 degrees (3 digits)	-	-
Address 88	-	-
Wind strength* in target area 00- 99 km/h (2 digits)	-	-

*If not added here, the wind direction and strength is sourced from the aircraft (either programmed wind or Doppler readings)

RB 15 procedures

HUD symbology in mode ANF and in mode NAV/ SPA (after trigger unsafe) when using the RB 15 is the normal navigation symbology with a distance line with markers. The markers indicate the maximum release distance, and the minimum release distance by a flashing distance line.

If time on target has been set for the missile, the fin of the flight path vector (airspeed deviation indicator) indicates the error in the time table. If the fin is on the flight path vector, the release point will be reached at the correct time.

In master mode ANF and radar mode A1 with the RB 15 selected (ATTACK on weapon selector) the CI will display a radar picture with symbology for RB 15 release. The circle marker is the assumed target position Bx8, and the cross the course change point Bx7. In mode T0 (fix trigger released) this is displayed regardless of the current waypoint as destination.

With the fix selector in mode T1 (first detent) the symbols can be moved with the radar control stick.

- If the destination indicator displays Bx 8, the assumed target position, the cross is moved to the circle marker, and both symbols are moved with the input from the radar control stick.
- If the destination indicator displays Bx 7, the circle marker is fixed on the target position (Bx8) and the cross follows the input from the radar control stick.
- If the destination is neither Bx 8 nor Bx 7, the circle marker and cross are moved to the current destination when the fix trigger is in position T1 (first detent). The markers follow the input of the radar control stick.

Note: BX 6-9 points are selected like normal BX markpoints (Data mode AKT POS /IN, press BX waypoint button followed by the corresponding number button the data panel)

Warnings and indications

The altitude warning light on the CI and the time / distance line on the HUD are used to warn the pilot in the following manner:

Altitude warning light.

Regardless of release mode (ANF or NAV/ SPA) the light will be lit with a solid light in case a CK error or Primary data error (primary pitot system).

In mode ANF, the light will be lit if:

- Target position (Bx8) not defined
- Set course change is $> 135^\circ$
- The sum of the ordered course changes is $> 135^\circ$
- Missile time of flight to the self-destruct point (Bx 9) is < 30 seconds.

In all these cases, release is inhibited when the altitude warning light is lit.

Note.

Pulling the trigger when the release is inhibited will cause the stores released light to flash. This is reset when the trigger is set to safe, in order to reset the release circuits.

The solid light on the altitude warning light is also used for indicating that the aircraft is outside of the release altitude envelope (50 – 2000 m). Launch is not inhibited in this case.

Target position fix

The RB 15 BX waypoints can be fixed by using a radar target fix, in the same manner as a normal target waypoint fix. Select the waypoint as a destination by setting the data selector to AKT POS, pressing BX and then the desired waypoint number on the data panel (same method as selecting a mark point Bx 1-5).

With RB 15 selected in mode ANF, fixes can be made according to the procedure below:

- Fix on Bx 8 results in:
 - Target position Bx 8 is updated (or defined if not done previously)
 - Positions of the other RB 15 waypoints (Bx 6, 7, 9) updated parallel to the movement of Bx 8. This can be seen as a “group” fix, moving all the RB 15 waypoints at the same time.
- Fix on one of the other RB 15 waypoints (Bx 6, 7, 9) will result in only the selected waypoint being moved.

CAUTION: Fix on a point that is a **not** a target waypoint and that is **not** a RB 15 waypoint will result in an own position fix, which affects the **entire navigation system**.

Descent point fix

The descent point BX 6 is always displayed on the CI with the coordinates that correspond to where the descent is started.

When updating the descent point by radar fix, the cross marker will move along the missiles flight path. Moving the radar stick forward will move the marker towards the target and backwards towards the aircraft.

It is not possible to place the descent point (BX 6) either too close to the aircraft, too close to the target or during the course change.

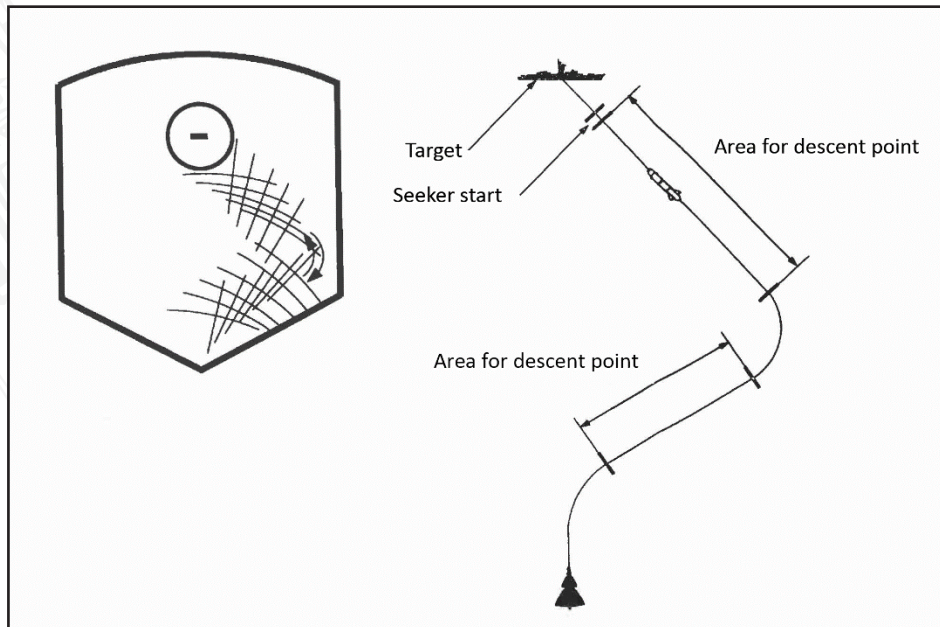

Figure 223. RB-15 BX fixes

Course change fix

The course change point BX 7 cannot be placed too close to the target. The cross marker is steerable towards the target up to the minimum distance away.

Self-destruct fix

The self-destruct point is where the missile will fly towards in the case it has missed or not detected a target in the set target area. When the missile reaches this point self-destruct.

Quick mode

The quick mode is used when the Master mode selector is in position NAV and trigger UNSAFE. The set target points and all other settings are not loaded onto the missile. The missile is just set to fire straight ahead and start search for targets.

The pilot directs the aircraft (set flight path vector above or on the target / target direction) and releases the missile.

On the HUD, the time distance line indicates the release envelope relative to the current destination. If the destination is not the target / target area, the pilot will have to judge the distance visually or by use of the radar display.

RB 15F Checklist

1. Weapon selector: ATTACK
2. Targeting mode selector: Desired position. VALB for pilot inputted data, STD for standard mode.
3. Set altimeter pressure (QFE)
4. Master mode selector: ANF
5. Search for targets with the radar, if needed make a radar target fix (BX8) to set an ATP.
6. Fly towards the commanded altitude or within the release altitude envelope (50 – 2000m)
7. Trigger: UNSAFE and fire when the HUD indicates within the release parameters.
8. Evade and trigger SAFE. Master mode: NAV.

Notes.

“Quick” release mode is used when the trigger is unsafe in mode NAV or SPA. Missile will lock on the first target it detects in front of it.

BK 90 “Mjölñir”

The BK 90 cluster munitions dispenser is used against concentrations of troops by flying over and discharging submunitions over a defined target area. Being fully autonomous after release, the weapon will guide itself to the target and thereby allow stand-off capabilities.

Two types of submunitions can be loaded, either the high explosive / fragmenting MJ1, the armour piercing MJ2, or a mix thereof.

The releasing aircraft does not need to fly over the target to reach the target, and is completely free to maneuver after release.

The range of the weapon is based on the release airspeed and altitude. Release is possible between M 0.6 – M 0.9 at altitudes between 50- 500 m AGL. On release, the weapon will steer towards the designated target that is loaded onto the weapon’s navigation system. As can be seen below, the aircraft does not necessarily need to be pointed at the target as the missile has limited horizontal steering capabilities.

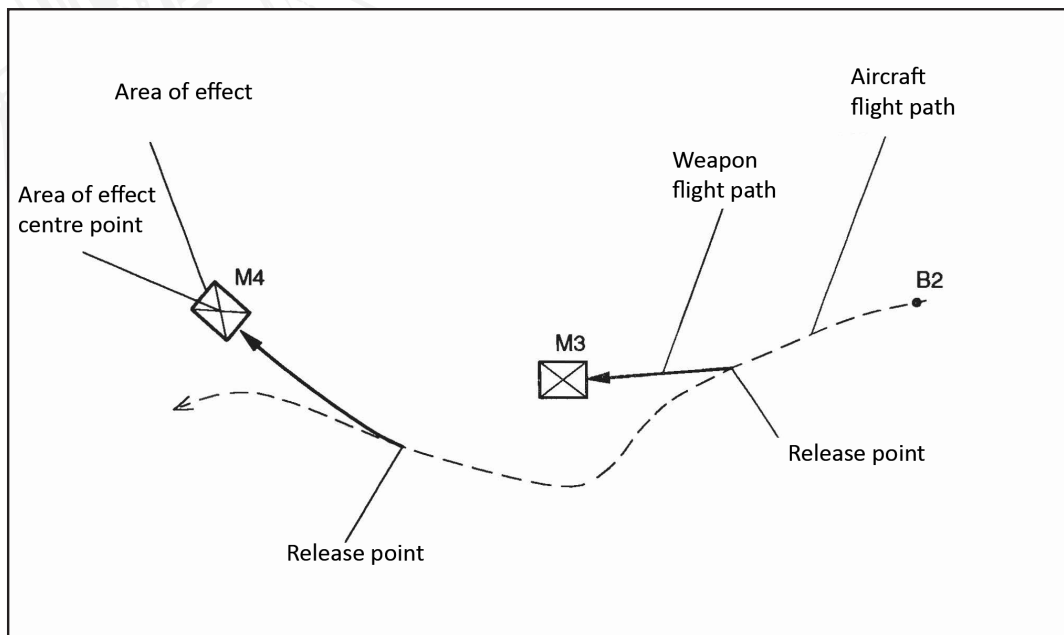

Figure 224. Typical BK 90 attack on multiple target areas (M3 and M4).

Flight profile

On release, the weapon will descend to its approach altitude. The radar altimeter in the weapon will maintain a constant altitude above the ground.

Approach altitude

The approach altitude can be set by the pilot or a default value may be used. The Target mode selector / preparation selector switch VALB / STD is used to toggle between the different modes. A higher altitude may be desirable in hilly terrain to give the weapon a greater chance to avoid obstacles.

VALB (selectable): The weapon's altitude is set by the value in address 91 in mode TAKT/IN. Possible intervals is set to 30 – 500 m. For example 912000 will set 200 meters, 915000 will set 500 meters (The last 0 does not do anything).

After clearing in mode TAKT (Pressing RENSA / CLEAR while in mode TAKT, however this will clear *all previous* TAKT inputs) or entering value 0 (910000), the default altitude of 60 m is reset.

STD (Standard): The default value of 60 m is set.

Attack altitude

The attack altitude is always 60 metres AGL.

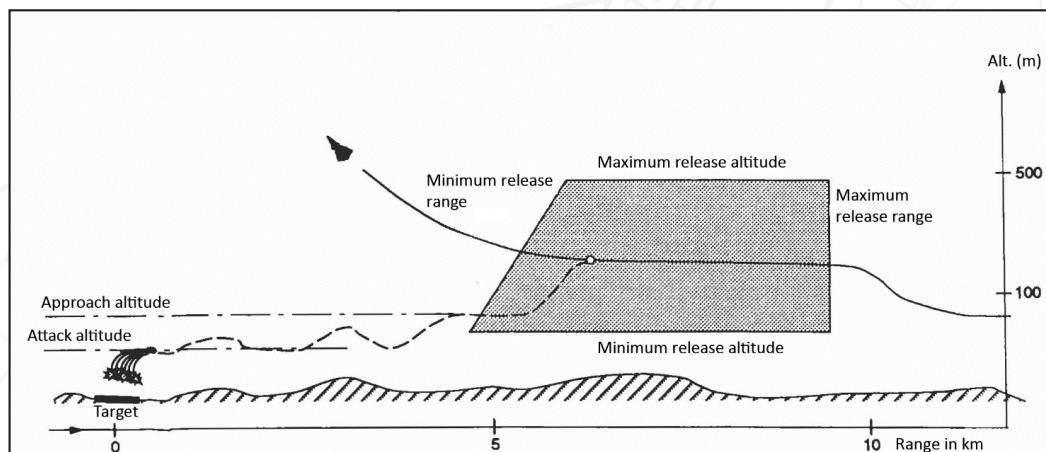

Figure 225. BK-90 Attack profile.

Radar altitude will be used for the altitude calculations if the radar altimeter is operating, if not, the barometric altitude is used.

Release area

The kinetic energy of the weapon determines the flight envelope of the weapon as it is not self-propelled. The aircraft airspeed and altitude at the moment of release will determine the size of the weapon's flight envelope.

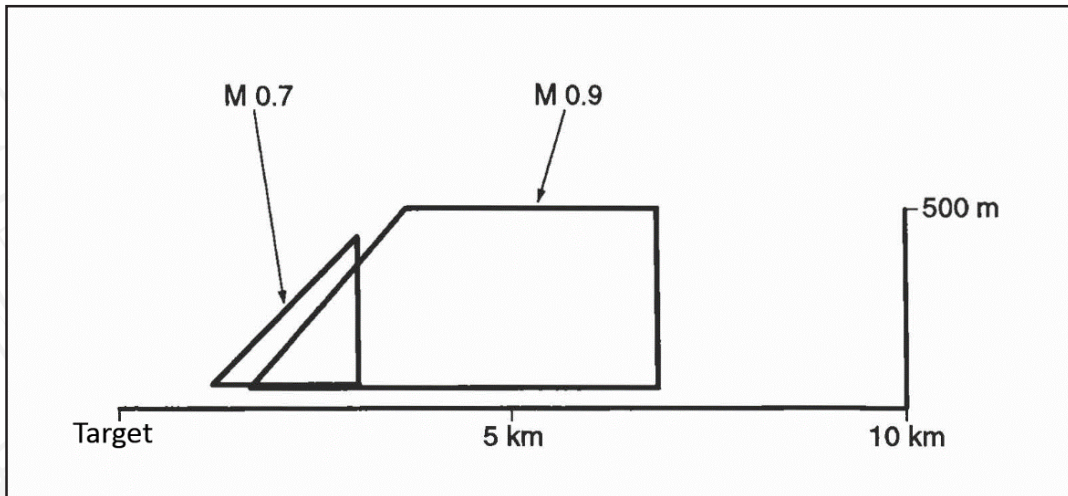

Figure 226. BK-90 release envelope (altitude and speed)

The aircraft will continually calculate the flight envelope of the weapon if released, and thereby whether the target can be reached and the submunitions delivered.

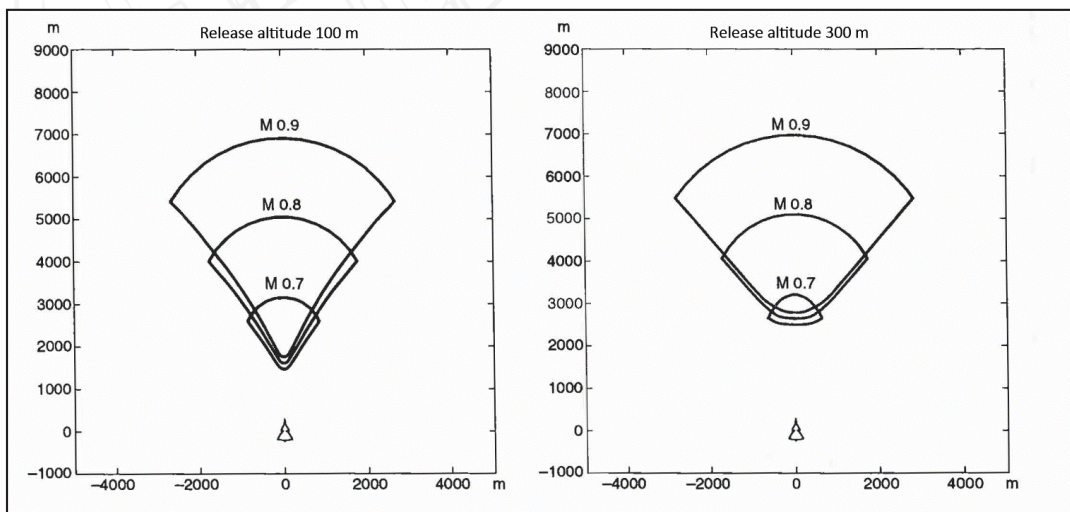

Figure 227. BK-90 release envelope.

The example below illustrates how the flight envelope of the missile is calculated and “moved” with the aircraft. In this example, the aircraft have two BK 90 dispenser pods and are fired singly at two different target areas.

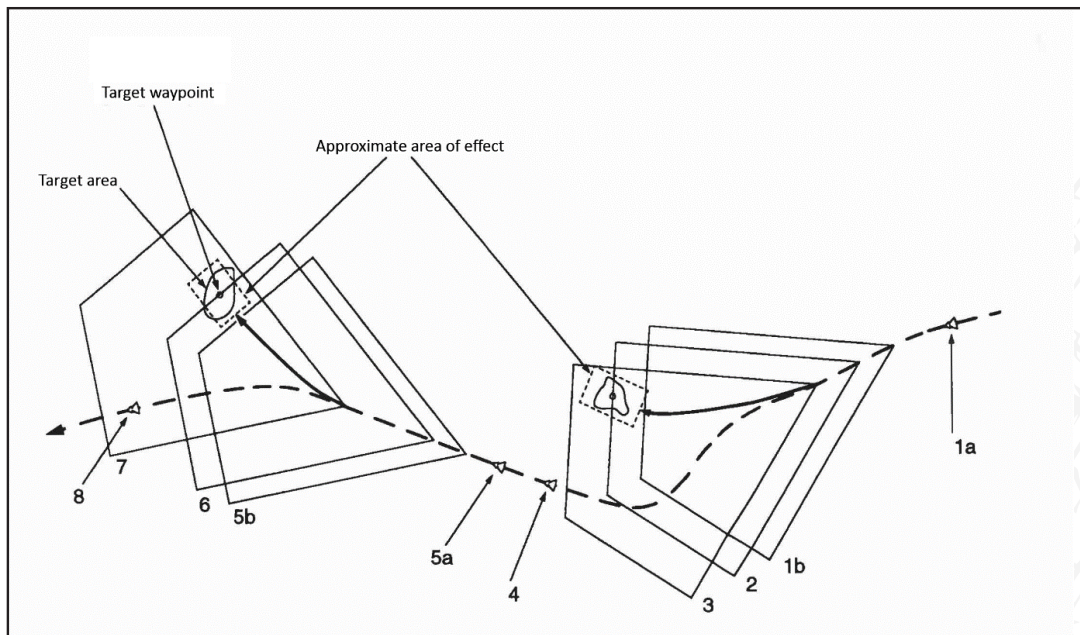

Figure 228. BK-90 moving release envelope

7

- 1a, 5a: Aircraft position before trigger unsafe.
- 1b, 5b: Weapon flight envelope at trigger unsafe.
- 2, 6: Target at the maximum firing range.
- 3, 7: Weapon flight envelope on weapon release.
- 4, 8: Aircraft position when the weapon reaches the target.

HUD symbology

The HUD symbology in the BK 90 mode is very similar to that of the normal navigation symbology. The time / distance line is used to indicate whether the target is within the weapon flight envelope area.

Markers appear on setting Master mode ANF or (NAV / SPA after trigger UNSAFE). Positioning of the markers is indicating the calculated time between the minimum and maximum release range in the flight envelope of the dispenser pod. Every degree represents 10 s, so the maximum time span that can be presented is 30 seconds (HUD distance line is 3 degrees wide).

If the time between minimum and maximum is less than 3 seconds, the markers will flash, indicating that the release parameters will not be met anymore. If the aircraft would steer towards the target, the “longer” release envelope will be indicated. If the airspeed is too low, so that even the 3 seconds criterion is not fulfilled, the markers will flash even when pointing towards the target.

The time / distance line appears when the time to the minimum release range is 30 seconds away, and will start flashing when the minimum release range will be reached within 2 seconds.

After the aircraft has reached the minimum release range, the time / distance line will be fully extended to indicate that the minimum range has been passed. The markers will then be placed at the 3 second position, as seen in the diagram below.

7

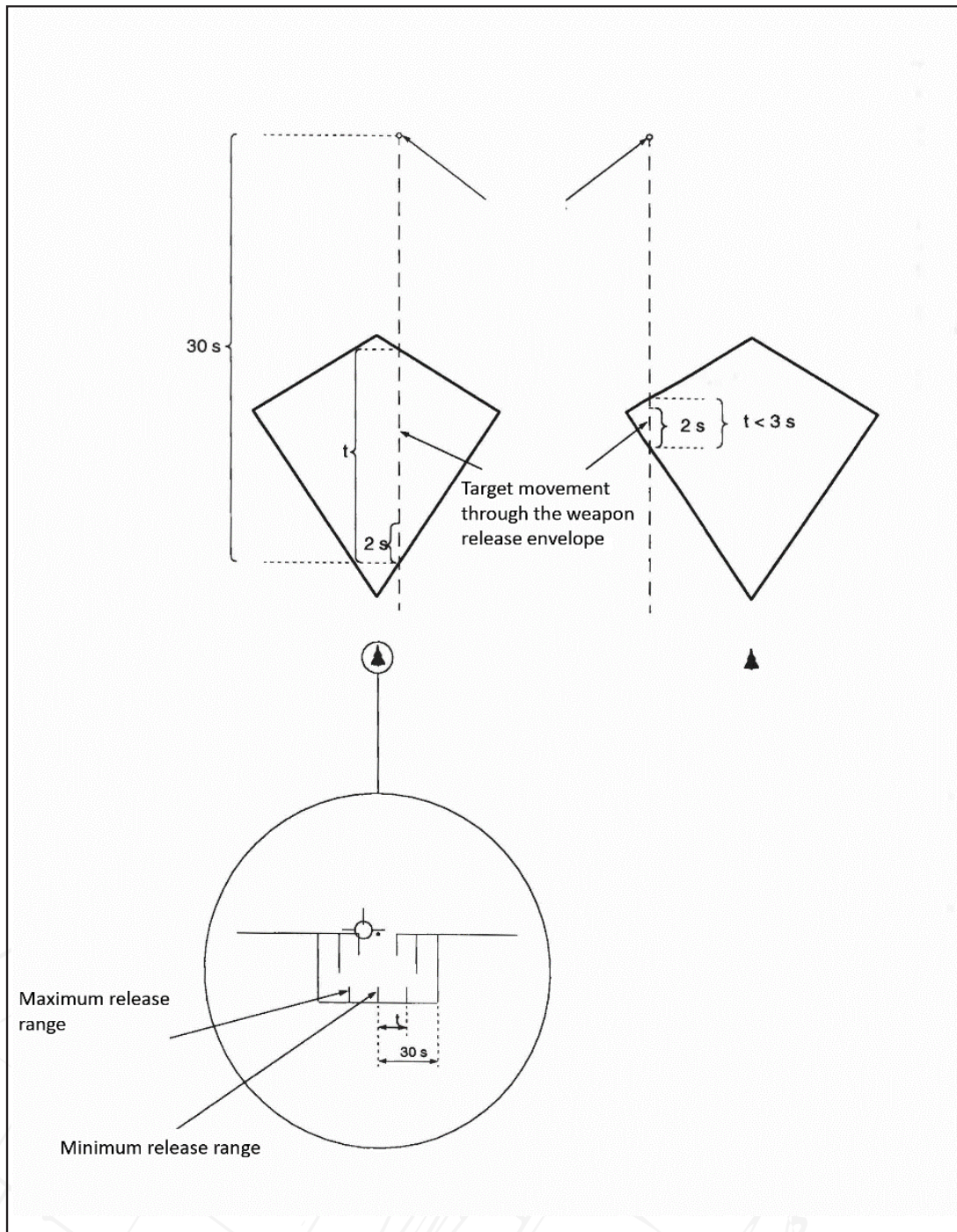

Figure 229. BK-90 HUD symbology.

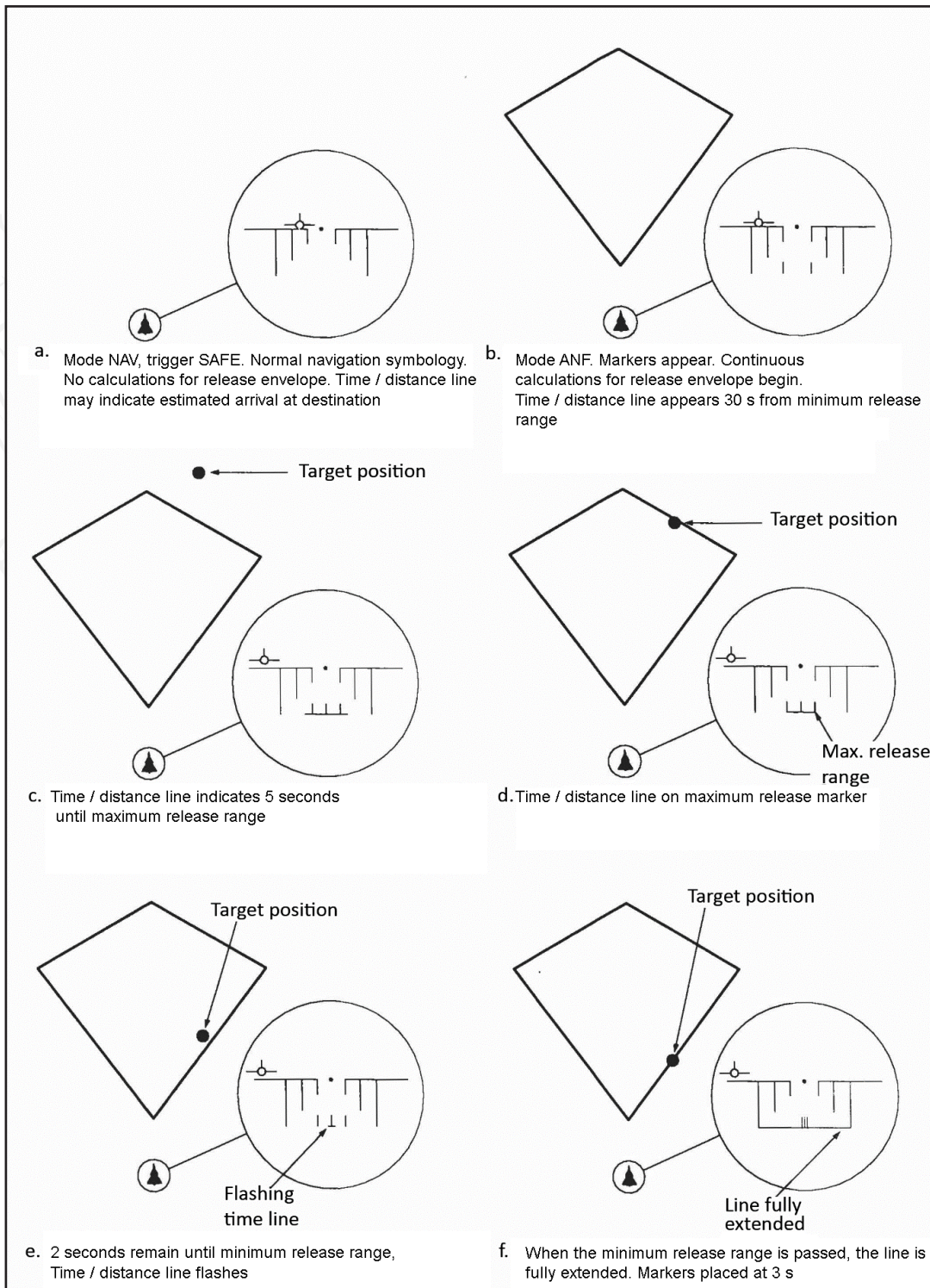

Figure 230. BK-90 HUD symbology and release envelope.

Release types

Release mode is determined by the position of the release mode selector IMPULS / SERIE. Release of the first dispenser pod occurs about 1.3 second after the trigger is pulled. If in series, the pods are released with 1.5 second intervals. The pilot will have to make sure that all pods can be released within the release envelope.

SERIE (Series)

When two or more dispenser pods are loaded, they can be released in series by setting the release mode selector to SERIE.

The area of effect pattern can be set via address 92 in mode TAKT / IN. Confirm entry by pressing LS.

1000 (921000): Long area

2000 (922000): Wide area

3000 (923000): Compact area.

0000 will reset any entry and set the default compact area.

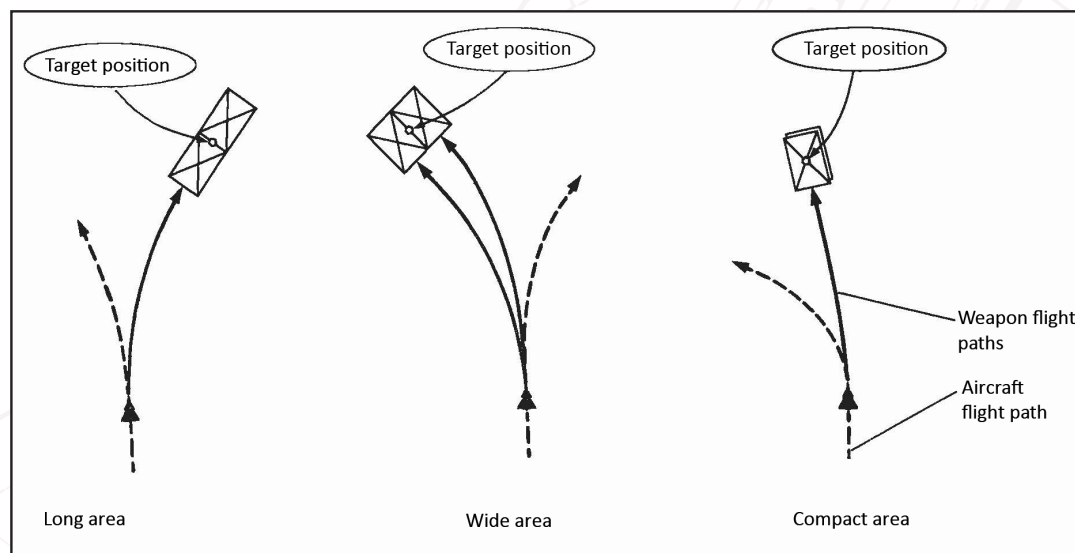

Figure 231. BK-90 area types.

IMPULS (single)

Each pull of the trigger will release one weapon.

Indication

Stores released indicator light:

Solid light: All dispenser pods released if in mode series.

Flashing light: Not all pods released if in mode series.

Altitude warning light

Will be lit with a solid light if outside of the release altitude envelope if in mode ANF or NAV / SPA with trigger UNSAFE.

BK 90 Checklist

1. Master mode selector: mode ANF (or NAV / SPA).
2. Confirm target as current waypoint in the destination indicator.
3. Weapon selector: mode ATTACK.
4. Release mode selector: IMPULS (Single) or SERIE (Series).
5. Set altimeter pressure QFE.
6. Fly between 50 – 500 metres AGL.
7. Trigger: UNSAFE.
8. Fire when the distance line in the HUD is within the release envelope. In mode IMPULS, each pull of the trigger will release a weapon. In mode SERIE, the weapons will be released with 1.5 second intervals. Keep trigger pulled until all the weapons are released, which is indicated by the FÄLLD LAST light being lit with a solid light.
9. Evade and set Master mode NAV.

Notes:

Manual destination change after release may be necessary as the aircraft can release the weapon without overflying the target area.

Air to Air weapons employment

In the air-to-air role, the AJS has the option of either using IR guided Sidewinder missiles, the AKAN gun pods, or the RB05 in an air-to-air fusing.

Radar usage

The radar can be used in a limited air-to-air mode, which is used to roughly determine the position of potential targets. The radar mode is essentially the ground mapping radar but elevated upward. As such, it is unable to display targets as specific symbols or targets, but merely radar returns in an unfiltered form. The performance of the radar is dependent on the contrast between the target aircraft and the ground clutter. The radar in search mode cannot be used to lock the target.

However, the radar can be used for ranging to determine whether the target is within the selected weapon's envelope.

The air-to-air mode is selected by setting the weapons selector to any of the air-to-air weapons positions: RB05 LUFT (rb05 A/A), AKAN JAKT (gunpods A/A), or IR-RB (IR missile) and then setting the radar mode to either A1 (PPI) or A2 (B-scope)

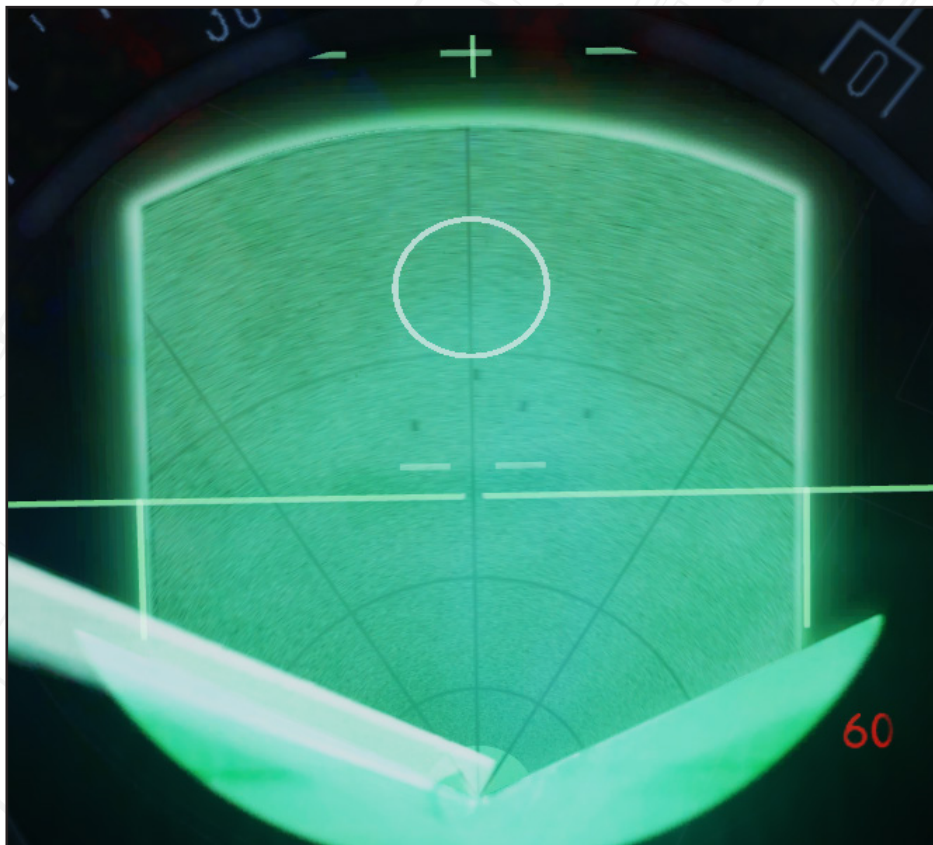

Figure 232. Radar in Air-to-Air mode. 4 aircraft at about 38 km away, likely large transports

The elevation of the radar is centred to $+1.5^\circ$ relative to the horizon, and can be manually elevated using the radar elevation knob. In the air-to-air mode, the antenna elevation indicator is added to the top part of the radar scope indicating the elevation of the beam relative to the 1.5° centre.

Air to air Gun pods AKAN

AKAN gun pods can be used for air-to-air engagements as well as ground attack. The gun pods can be sighted in two modes, either by setting the wingspan, or using the radar to determine range.

In the wingspan mode, the wingspan is set by moving the sight mode selector to the wingspan of the identified aircraft. The wingspan markers in the HUD represents the wingspan of the set target size as 500 metres distance. The sight calculations will be correct at this point, but it is necessary to “lead” the target if it is manoeuvring.

Examples of wingspans:

Il76 "Candid" 50 m

MiG-23 "Flogger" 13 m (wings extended)

MiG-21 "Fishbed" 8 m

Su-27 "Flanker" 15 m

In the radar ranging mode, the sight will count down to the recommended 500 meter distance. As with the wingspan mode, the pilot will have to lead the target manually.

Gun pod AKAN air-to-air Checklist

1. Weapon selector: AKAN JAKT.
2. Sight mode selector: Target wingspan.
3. Master mode selector: ANF.***
4. Radar mode selector: A1 or A2.***
5. Place the sight dot over the target aircraft and lock the target by pulling the fix trigger to the first detent (T1).***
6. Trigger UNSAFE and fire when the time / distance line reaches the event markers*** or, Wingspan markers envelop the target.
7. Trigger SAFE and master mode NAV after firing.

*** May be omitted if using the wingspan method.

Notes.

- Sight calculates for 500 metres range to target.
- Rescaling of the distance line from 8 km to 2 km occurs at 2 km distance.

RB 05A

The RB 05A can be used in an air-to-air capacity. Missile guidance and general usage is very similar to air-to-ground use. A radar proximity fuse will detonate the warhead when the missile passes near an aircraft. Range is highly dependent on the relative airspeed between the aircraft. The air-to-air differs from the air-to-ground in the HUD symbology. The radar can be used both for roughly finding the target and for ranging.

Generally, the missile will perform very poorly against any form of maneuvering target and can only really be used against transports. However, the very large warhead is excellent for that purpose.

The missile can be fired with or without the use of the radar for ranging. If not using the radar, the wingspan markers can be used for ranging. The recommended firing range is 2800 m. The HUD symbology only serves as a method to estimate range and will not affect the guidance of the missile.



Figure 233. RB-05 being guided onto a target.

RB 05A A-to-A Checklist

1. Weapon selector: mode RB 05 LUFT.
2. Sight mode selector: Target aircraft wingspan.
3. Radar mode selector: A1 or A2.
4. Master mode: ANF (or NAV).
5. Trigger: UNSAFE.
6. Steer the aircraft towards the target aircraft and lock the target by setting the reticule over the target and pulling the fix trigger to the first detent (T1).
7. Engage autopilot ATT or HÖJD if desired.
8. Fire the missile at 2800 metres distance when either: the distance line reaches the markers or, wingspan markers envelops the target.
9. Manually guide the missile onto the target. Do not attempt to lead the target with the missile. Instead, attempt to superimpose the missile on the target aircraft and keep it there until impact.
10. After impact, trigger SAFE and Master mode NAV.

7

Notes.

- RB 05 can also be fired in master mode NAV.
- Recommended firing range 2800 metres.
- Rescaling of the distance line from 8 km to 4 km occurs at 4 km distance.

RB 24J/RB 74

The AJS-37 can carry two variants of the AIM-9 Sidewinder; the older, rear-aspect RB 24J (AIM-9P) and the all-aspect RB 74 (AIM-9L). The missile can be aimed with or without using the radar to determine the range to target.

When selected, a growling audio tone will be sent from the seeker to indicate whether a target is locked. When a solid tone is heard, the seeker has locked onto a heat source.

The main difference between the RB 24J and the RB 74 is the sensitivity of the seeker. The RB 74 is an all-aspect missile where it can lock an aircraft from the front-aspect as well, rather than only from behind an aircraft like the older rear-aspect RB 24J.

Seeker uncage

When the missile has acquired a heat source, the audio tone will change. The missile seeker head can be uncaged to maintain the lock on the heat source outside of the centre bore-sight. This is done by pressing the IR missile uncage button on the throttle. When uncaged, the locked target will be indicated by the IR target ring (ITR). The ITR is restricted to $\pm 6^\circ$ horizontally and $\pm 10^\circ$ vertically on the HUD, however the seeker may be locked on a target outside of the display area. The pilot will have to estimate the position of the target based on the position of the ITR.

Over G indication

The missile will have difficulty tracking a target if the aircraft is under an excessively high G-load. This is indicated by the “wings” of the flight path vector appearing. Maximum G-load for the RB 24J / 74 launch is 6 G.

IR missile fast select

Sidewinders can be selected quickly by pressing the AFK quick disconnect / IR missile fast select button on the front of the throttle. Each press of the button will cycle the next selected missile. This cannot be used when the landing gear is extended.

HUD symbology

The same HUD symbology is used in master mode ANF with the weapon selector in mode IR-RB as well as after fast selecting the IR missiles in master mode NAV, SPA and LANDING and trigger UNSAFE. The missile is boresighted to the centre of the boresight indicator.



Figure 234. Sidewinder HUD symbology.. Missile uncaged.

RB 24 / 74 Checklist

1. Weapon selector: IR-RB (or press IR missile fast select).
2. Sight mode selector: Set target wingspan.
3. Master mode selector: Mode ANF.
4. Radar mode selector: Mode A1 or A2.
5. Aim at the target visually and engage radar lock by pulling the fix trigger to the first detent (T1)
6. Confirm sidewinder growling tone. Adjust volume if necessary.
7. Uncage seeker if needed (manoeuvring target).
8. Trigger: UNSAFE and fire on sidewinder steady tone, if distance line indicates inside of max range or wing span markers envelop the target (when not using radar ranging).
9. Trigger: SAFE and master mode: NAV.

Notes.

- Missile will launch about 1 second after the trigger is pulled.
- Flashing “wings” in the HUD indicates that the G-limit (6 G) of the missile is exceeded.
- In NAV, the radar ranging is only possible after trigger UNSAFE.
- Flashing distance line indicates the minimum firing range has been passed (500 m).
- Rescaling of the distance line from 8 km to 4 km occurs at 4 km distance.

Reconnaissance

Introduction

The reconnaissance (recce) functionality of the AJS-37 is naval reconnaissance via the radar to determine the position, course and speed of ships at sea. Most of the reconnaissance functions are used in master mode SPA.

Two main sub modes exist for the reconnaissance

SPA/ MÅL: Target measurement mode. Used to determine the position of reconnaissance targets such as ships. Yields a coordinate with a timestamp.

SPA / SKU: Target tracking. Used to determine the course and speed for previously measured targets.

Important NOTE:

The term *target* will be used in this chapter. These target are reconnaissance contacts recorded by the system and is entirely separate from that of the normal waypoint targets.

A measured target is a simple position fix on a contact (indicated by a *red M* on the destination indicator). These positions are referred to as *M1-M9*, but are separate from the normal "white" *M1-M9* (which are waypoints made into target points). Where possible the reconnaissance target points will be referred with the italicized *M*.

A tracked target is a contact that has been fixed on twice to determine its course and speed (indicated by *S* on the destination indicator).

On the whole, the normal navigation polygon system is rarely used for reconnaissance purposes.

Developers Note.

While the system is designed for maritime / naval reconnaissance, the system can be adapted for recording the position of other objects / locations such as ground troops or installations. However, this is outside the scope of this manual .

The main goal of the reconnaissance system is to be able to quickly set a fix (either visually or via the radar). Then be able to view the location (subject to the quality of the navigation system) and timestamp of that fix in the computer, instead of manually writing down that information.

Flight profile

Below is a typical flight profile for a reconnaissance mission.

Normal waypoints are just used as geographic reference points (such as passing B1 to confirm that the navigation system has a good fix before heading out to sea). normal navigation waypoints. Normal waypoints are just used as geographic reference points (such as passing B1 to confirm that the navigation system has a good fix before heading out to sea).

R1-R4: Patrol square corner points. R6 is a middle point because R5 was not entered.

M1-M9: Reconnaissance targets. (Indicated by a red M on destination indicator). Note that the reconnaissance target points (Red M) are not normal target waypoints (White M, converted from B points) but entirely separate (White M, converted from B points).

S1: Tracked reconnaissance targets.

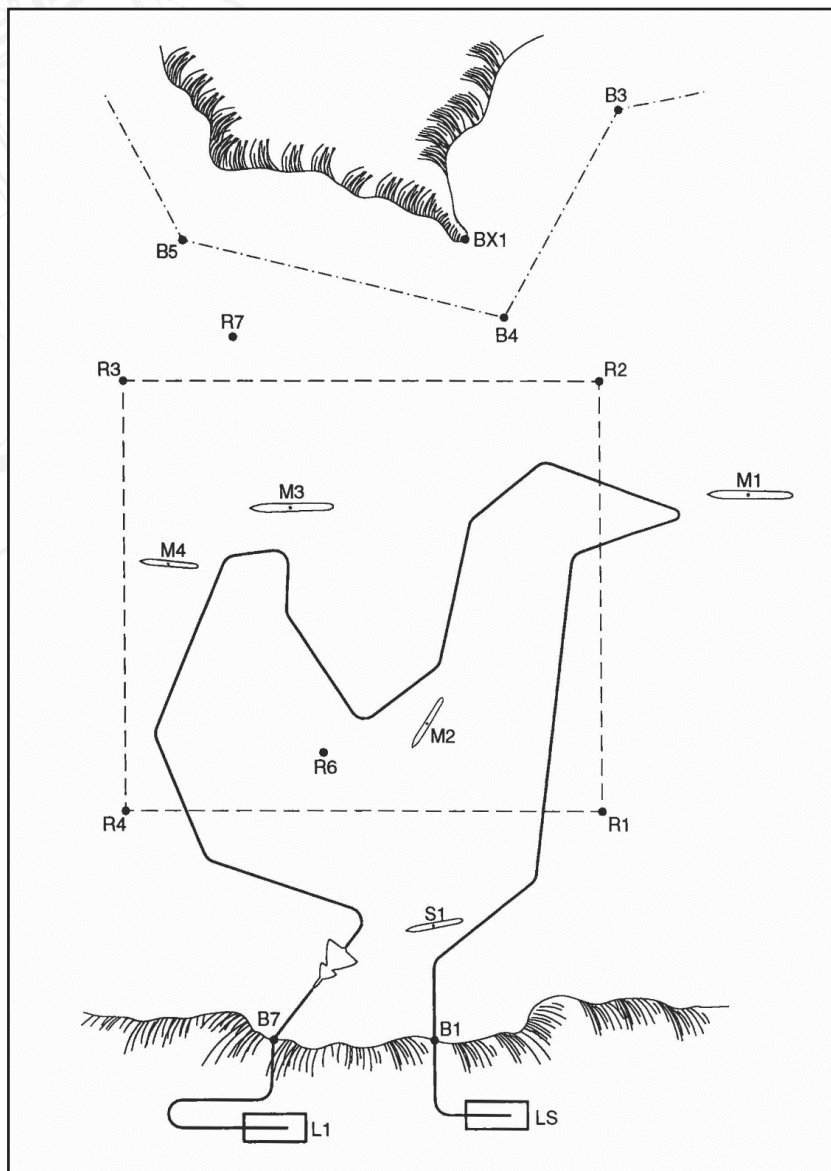

Figure 235. Typical reconnaissance flight plan with normal waypoints, patrol areas and measured targets. R6 becomes a middle point because R5 was not entered. Normal waypoints are just used as geographic reference points (such as passing B1 to confirm that the navigation system has a good fix before heading out to sea). Several contacts have been recorded (M1- M4) and a single ship has been tracked (S1)

RUTA (Patrol square) and display in mode SPA.

In order to make reconnaissance easier, there is a special display mode in the Central Indicator (CI) mode SPA. The display is in the form of a pre-determined patrol area (usually a square, but can be any other shapes based on the position of the corner points “R”).

Other displays are slightly changed in the following manner:

Timekeeping is paused, airspeed deviation fin is reset.

Fuel requirement is between the current position to the primary landing base, based on to requirement need to return to base with current parameters along with the set fuel reserve.

Automatic destination change is inhibited. When changing from mode SPA, the previous destination waypoint will be selected automatically.

Display on the data panel and destination indicator changes to the reconnaissance mode, which is addressed below.

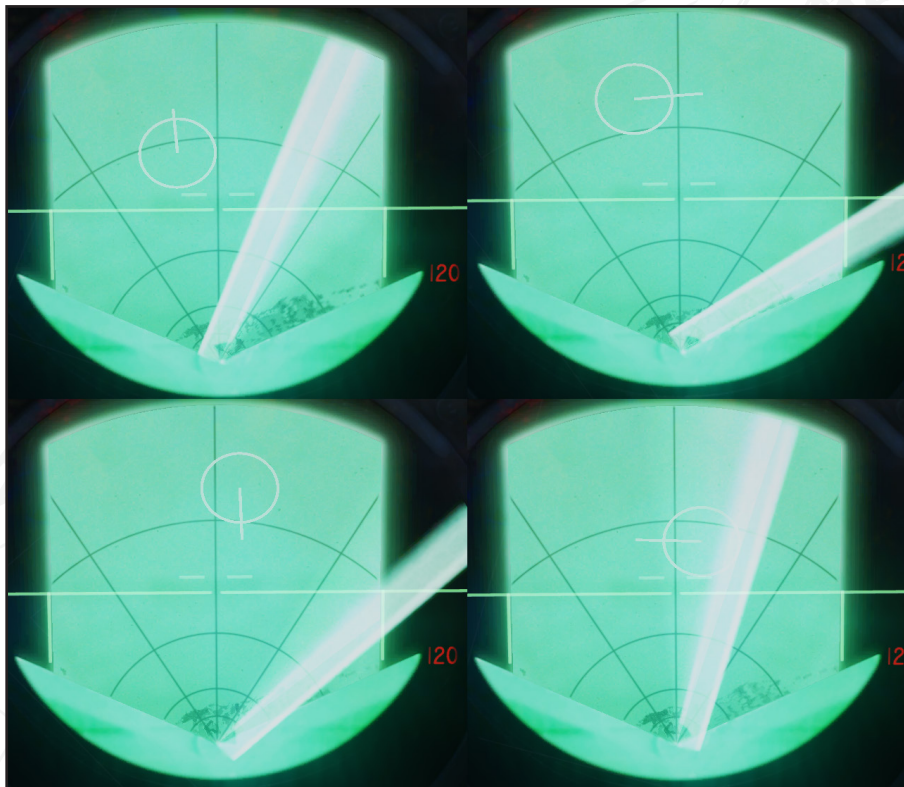

Figure 236. RUTA symbology.

RUTA

The patrol area is only displayed if the master mode selector is in mode SPA and the radar mode selector in modes A0 and A1. The RUTA display is automatically selected on switching to master mode SPA.

The RUTA display can be toggled with the normal destination display by briefly pressing the fix trigger to the first detent and releasing (T0-T1-T0). The CI will display the position and shape of the patrol area. The display is also changed to destination display on changing the destination.

RUTA is displayed with the circle marker and a line, similar to the boundary or extended runway indicator. The circle marker will “jump” between the corner points in sequence. The line will indicate the direction of the adjacent corner points, alternating between the two directions every second.

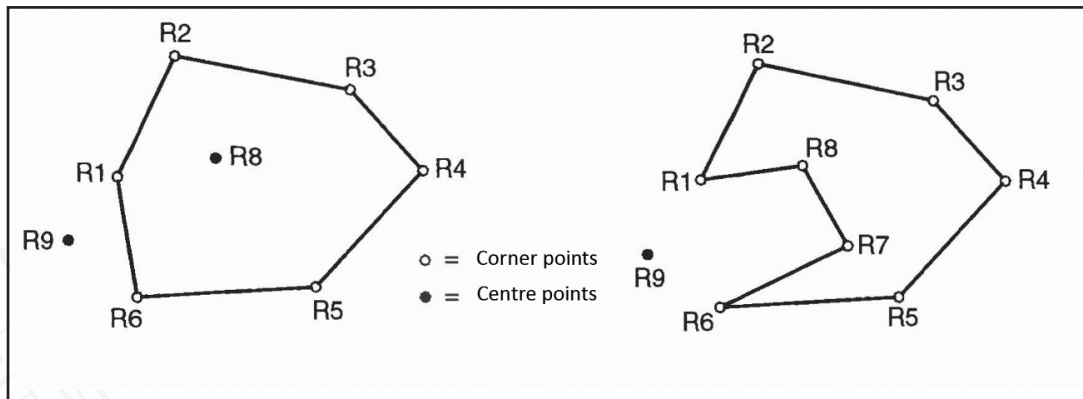

Figure 237. RUTA points.

In the example above, two different types of patrol areas defined by RUTA. Note that the layout of the corner points can take any form the pilot wishes, although it is better to keep the polygon as simple as possible.

There are two different types of RUTA points, either corner points or centre points.

Corner points: Normally constitute the boundaries of the assigned patrol area. Corner points are any points entered that are continuous from R1.

In the cases above, on the left example, R1 through R6 are entered. R7 is missing leading to R8 being a corner point.

Whereas in the right example, R7 is added to the sequence, leading to R7 and R8 becoming a corner point.

Centre points: Centre points are points added to the polygon, but will not appear in the radar on the normal SPA display showing the boundary of the patrol area. Instead, they are used as points of reference. Corner points are points entered, but not part of a continuous series.

R9 will always be a centre point.

For information how to set up the R points in the Mission Editor, please refer to the "I Mission Editor Settings" Appendix

Reconnaissance Target Measurement SPA/MÅL

The purpose of the sub-mode Target Measurement SPA/MÅL is to search a patrol area and record detected maritime or naval targets in order to determine their positions. In this mode, the pilot will make fixes on certain ships in an area via the radar or visually.

This information will then be stored and can be reviewed. Additional "out of system" notes may be necessary, such as manually writing down what type of ship the corresponding fix was.

Selection

Mode SPA/MÅL is obtained by default when setting the master mode selector to SPA.

The mode can be selected when in the tracking mode (SPA/SKU) by pressing the L/MÅL waypoint button with the data selector in mode AKT POS, or selecting a destination other than a tracking target by pressing any of the waypoint buttons B1-B9.

System

Discovered targets can be measured visually or by radar, similarly to a normal target waypoint. In mode SPA/MÅL, a target fix is not made for an existing waypoint, but a new reconnaissance target waypoint is created for each defined reconnaissance target instead.

The longitude and latitude of the contact as well as a timestamp of the target fix is stored in the system. The system can store up to 9 reconnaissance position targets *M1-M9*.

Each new reconnaissance target will be stored in sequence *M1-M9*. Any new target will be assigned to the next number in the sequence.

If all the slots are filled however, the previous contacts will be overwritten one by one, starting with *M1*. If the contacts have been entered manually (by manually entering the coordinates in the computer), they will never be overwritten. They can however be either cleared or overwritten by inputting a new coordinates on that slot.

Fixes

Visual reconnaissance fixes are made similarly to how a navigation or target fix is made, however in this case the current destination is irrelevant, as a new "fix slot" is made for each fix.

Prepare a fix by pressing the fix trigger to the first detent (T0-T1), when directly above the ship, press the fix trigger to the second detent (T1-TV) or cancel the fix by releasing the fix trigger (T1-T0). A new reconnaissance target will be created on the current position.

Radar fixes are made by setting the radar mode selector to A1 and making a radar fix on the ship's radar contact (similarly to how a normal radar fix is made by maneuvering the cross onto the target and pressing TV).

The data panel will indicate the bearing and distance to position of the radar cursor (cross). When the fix is made, the data panel will alternate between longitude and latitude on the first five digits. The sixth digit will alternate between a minus sign (when displaying longitude) and the reconnaissance target number (when displaying latitude).

The CI will display the completed fix point with the circle marker until a new destination is set, or a new fix is prepared.

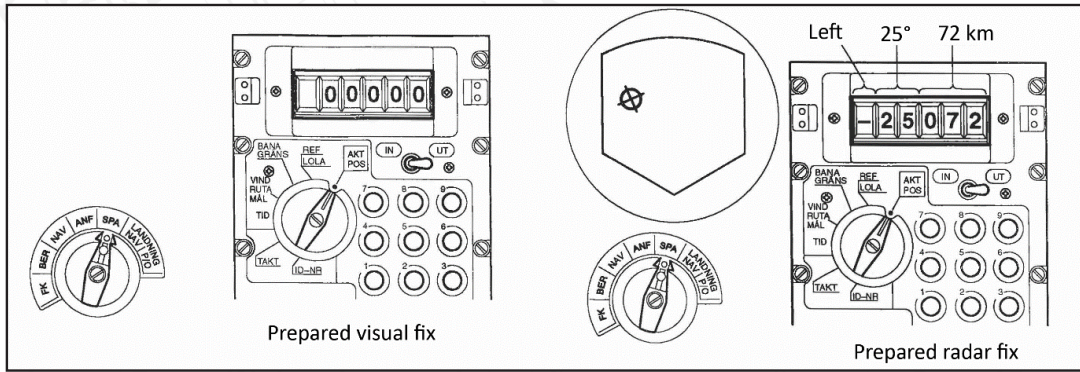

Figure 238. Prepared fixes.

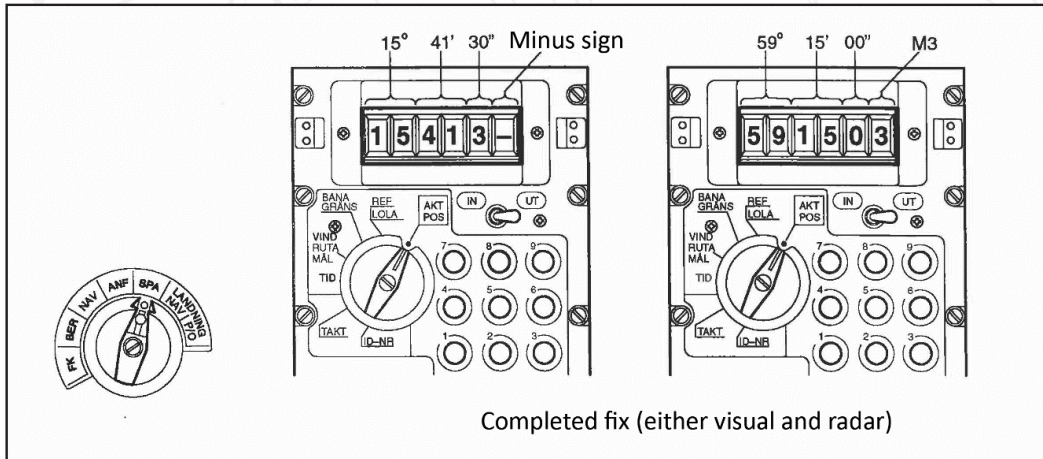

Figure 239. Completed fixes.

Transfer to tracking target

Data from the target measurement mode (MÅL) can be transferred to the target tracking mode layer (SKU). This is done by selecting the desired measured target in SPA/MÅL and then pressing the waypoint button LS/SKU **twice** in rapid succession.

A successful transfer is indicated by the tracked target number (S1 – S9) in the destination indicator.

A failed transfer (due to the tracking slots being full) is indicated by six minus signs. Transferred targets are assigned the lowest available tracking slot number.

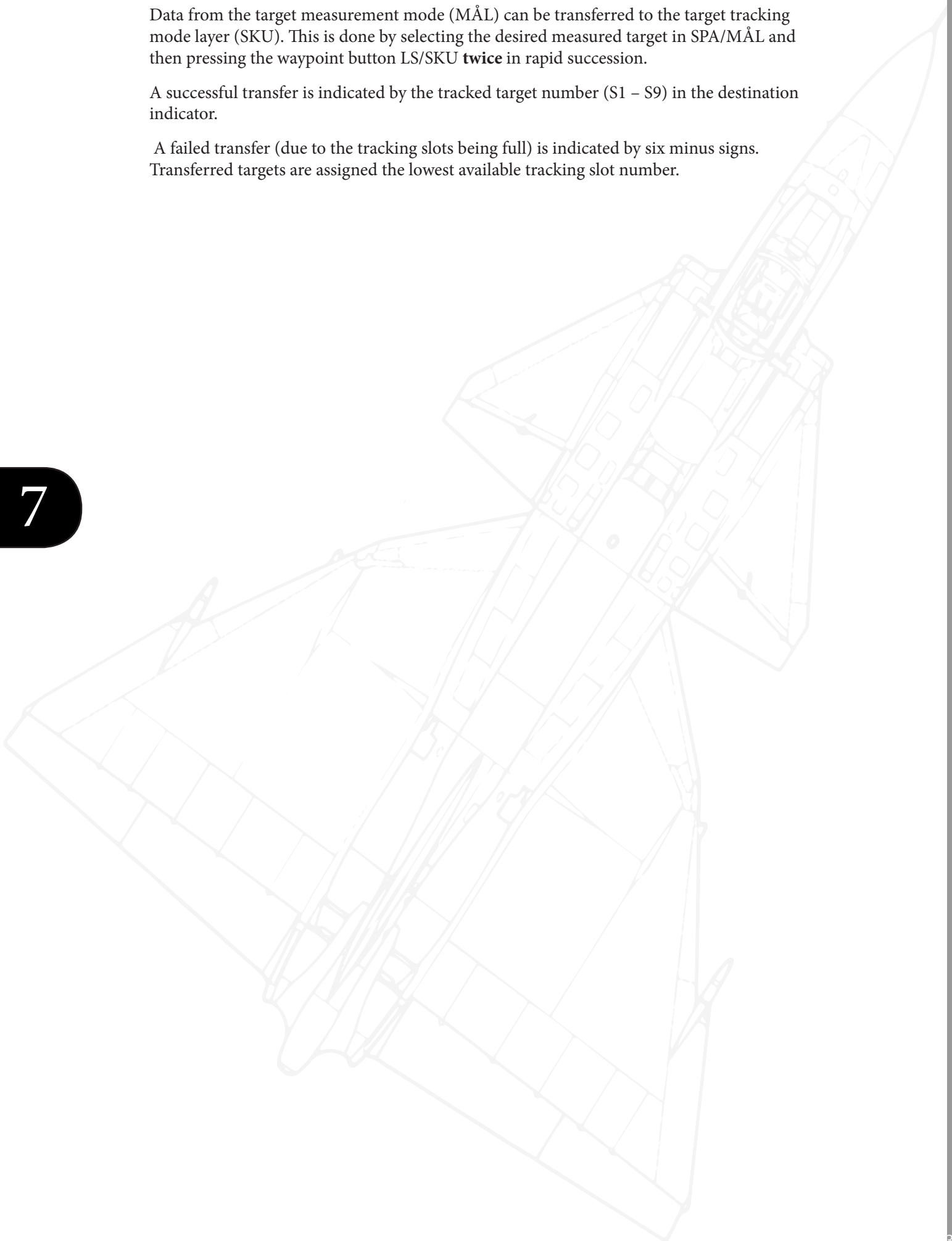

Reconnaissance target tracking SPA/SKU

The purpose of Target Tracking SPA/SKU is to determine the course and speed for previously discovered and recorded targets. Data is stored in a separate SKU data layer with room for nine separate targets (S1 – S9). Essentially the purpose is doubling the fix on the same target to determine course and speed rather than a single data point.

Selection

Mode SPA/SKU is selected, in mode SPA/MÅL and with the data selector in AKT POS, by pressing the waypoint button LS/SKU once.

This will result in the either latest selected, measured, or transferred target in the SKU layer being selected as a destination.

System

In mode SPA/SKU, only targets in the SKU-layer can be selected as a destination. A target is selected in the SKU layer by choosing the data selector mode AKT POS, then pressing the number (S1 – S9). As the tracking targets cannot be selected in any other mode than SPA/SKU, the mode is indicated by a tracking target being the destination (S on the destination indicator).

Fixes in SPA/SKU

A fix in mode SPA/SKU means that the position of the target is updated, as opposed to merely determining the position of the target in SPA/MÅL. Two fixes per SKU target can be stored, from which the position, course and speed of the target ship can be determined. The two fixes must be taken with at least 3 minutes in between. On taking a new fix, the most recent of the old fixes is kept, if it is at least 3 minutes old. If it is less than 3 minutes old, the oldest fix is kept and the more recent is overwritten by the new fix.

A SKU-fix that does not result in a target course and speed is called a type I fix. A transferred target from the SPA/MÅL mode is a type I fix. A SKU-fix that does result in a target course and speed is called a type II fix.

SKU targets can be determined either by visual fixes or by radar. Display will however be slightly different between the two types.

In mode SPA/SKU, fixes are prepared in the same manner as in SPA/MÅL. Prepare a fix by pressing the fix trigger to the first detent (T0-T1), confirm position of the ship when directly above it or when the cursor is on the target by pressing the fix trigger to the second detent (T1-TV) or cancel the fix by releasing the fix trigger (T1-T0).

When preparing a SKU-fix (either visual or radbyar fix) the destination indicator will display a red S. It can either be solid or flashing with different frequencies (1.2 or 0.6 Hz). The display has the following meaning:

- If the S is **flashing with 1.2 Hz**, this means that the SKU-target does not have any SKU-fix older than 3 minutes. If the fix is completed, it will result in a new type 1 fix.
- If the S is **flashing with 0.6 Hz**, this means that the SKU-target has two earlier SKU-fixes and one of them is older than 3 minutes and the other less than 3 minutes. If the fix is completed, a type II fix is made, resulting in course and speed of the target. It is however, calculated from the older fix, as the recent fix is too young and will be overwritten by the new fix.
- If the S is **solid** the SKU-target has one or two earlier SKU-fixes and it/they are older than 3 minutes. If the fix is completed, a type II fix is made. The course and speed will be calculated from the most recent fix and the new fix. The oldest fix will be overwritten.

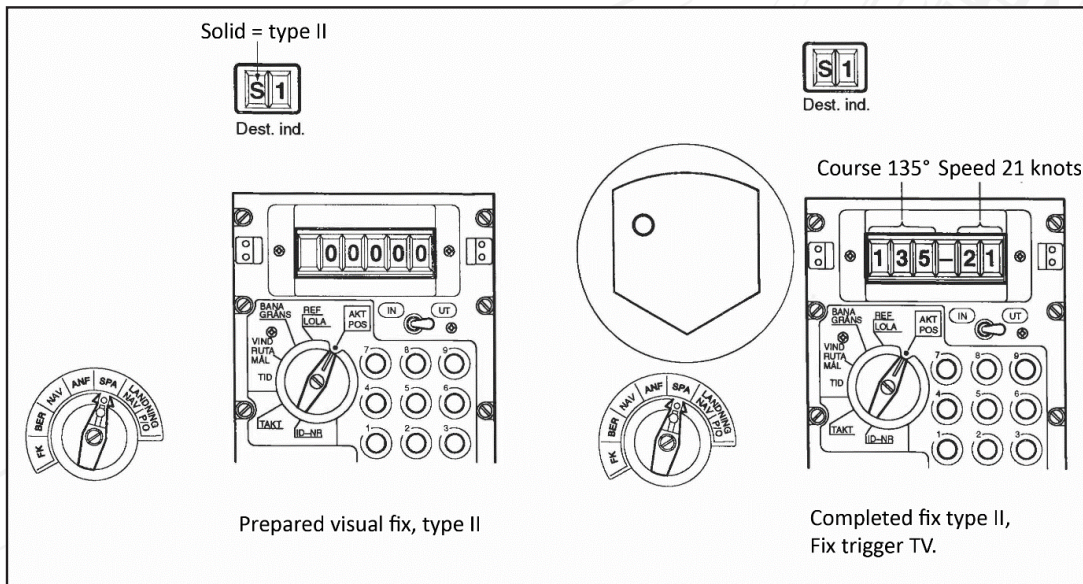
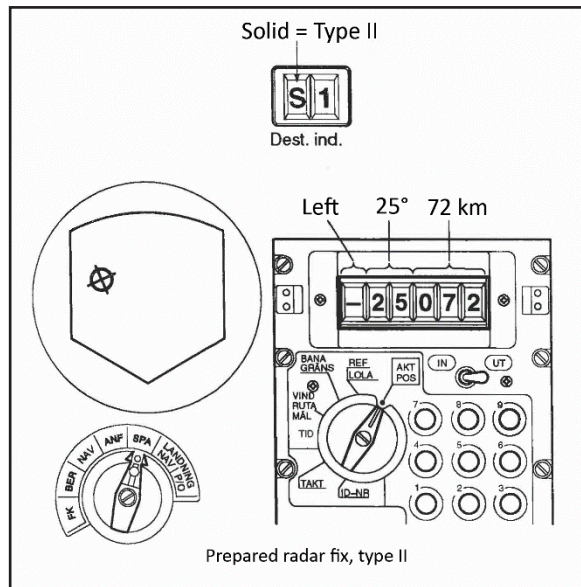

7

When the fix is completed, and the fix trigger is still held beyond the second detent (TV), the display on the data panel is dependent of the fix type. If the fix was a type II, the data indicator will display the target ship's course and speed (in knots). If the fix was a type I, six zeroes (0) will be displayed. The circle marker will remain on the target position (if using a radar fix)

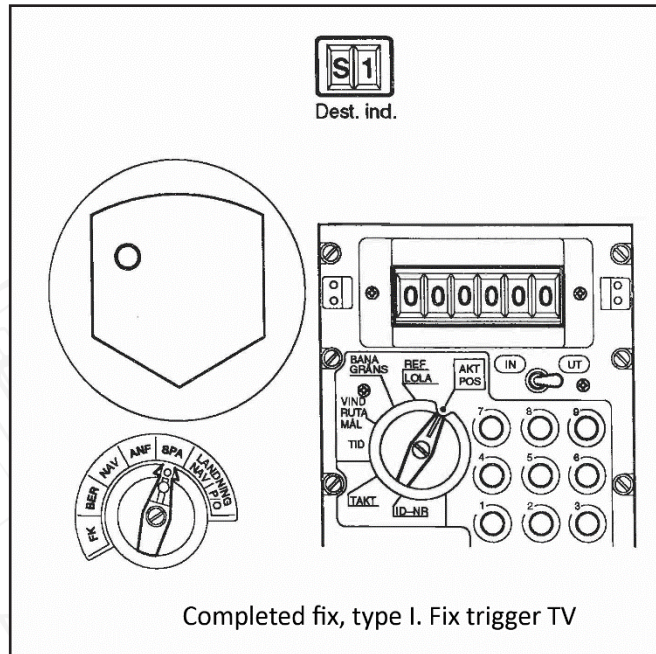

When the fix trigger is released to T0 after a completed fix, the data indicator's first 5 digits will alternate between the longitude and latitude, similarly to the display in SPA/MÅL. The last digit will alternate between the target number and a minus sign.

The data indicator and the CI will display the completed fix until a new destination is selected or a new fix is prepared.

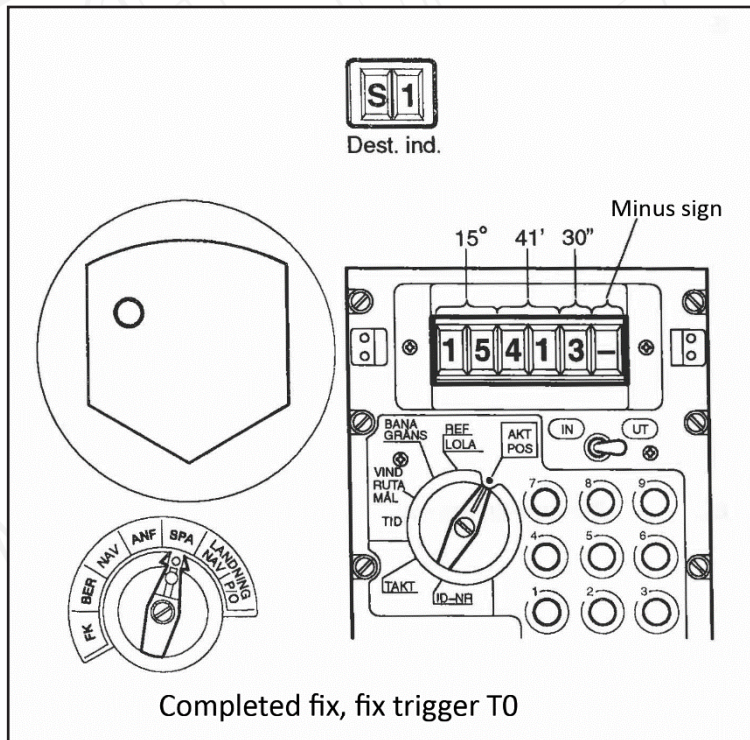

Data input / output for reconnaissance modes

Several reconnaissance functions are only programmable / accessible in mode SPA. Normally, pressing the RENSA (CLEAR) button while airborne will result in that the fixes being cleared, in mode SPA the button has other functions:

In mode SPA / MÅL (recce target measurement), the latest selected / measured target is cleared on the first press of the button, the second will clear all the measured reconnaissance targets if pressed within 2 seconds of the first press and no digit button or fix trigger has been pressed in-between. Individual targets can be cleared by entering 0 manually on the desired target.

In mode SPA / SKU (recce target tracking), the first press of the button will clear the latest tracking fix. The second press of the button will clear all the tracking fixes for the current destination.

Input VIND/RUTA/MÅL

With the data selector in mode VIND/RUTA/MÅL, coordinates or reference numbers can be entered for the RUTA corner and centre points, as well as for manually inputting reconnaissance targets (measured targets). Input can be made in any master mode.

Corner / Centre points

Input of corner and centre points (R1 – R8) is made by entering longitude, latitude or a reference number in the data panel, and confirming by pressing the corresponding waypoint button (R1 being B1). *Please refer to the in-game kneeboard for a list of the reference numbers specific to the map or created in the mission editor.*

Corner points are required to be in sequence starting with R1. If the sequence is broken, the new point becomes a centre point. Point R9 is always a centre point regardless of the sequence.

Manual input of reconnaissance targets

Input of measured reconnaissance targets (M1 – M9) is done in the same manner as the corner points. Enter the coordinates or reference number, and confirm by pressing waypoint button L/MÅL and then the corresponding number on the data panel (ex: button B2 for M2).

Measured reconnaissance targets, corner points and reference points are cleared by pressing the RENSA (CLEAR) button when on the ground, if the data selector is in modes AKT POS, REF/LOLA, BANA/GRÄNS, VIND/RUTA MÅL, or TID. Measured reconnaissance targets are cleared by pressing the RENSA button while airborne in mode SPA / MÅL selected.

Input TID

You may enter a timestamp on a manually entered measured reconnaissance target in mode TID. Input can be made in any master mode.

Input is made by inputting the time in hours, minutes and seconds and confirming by pressing L/MÅL, and then the corresponding number on the data panel.

Ex: Enter 150430, press LMÅL, and then B2 for M2, for a timestamp of 15:40:33 at measured target number 2.

Fix timestamps for measured targets are cleared by pressing the RENSA (CLEAR) button when on the ground, if the data selector is in modes ATK POS, REF/LOLA, BANA/GRÄNS, VIND/RUTA MÅL, or while airborne by pressing the RENSA button in mode SPA / MÅL.

Input TAKT

Stand-off warning

The purpose of the stand-off warning is to provide a warning so that the aircraft does to approach a reconnaissance target too closely. The set stand-off warning distance is common to all reconnaissance targets, and they cannot be set individually.

Prerequisites

Stand-off warning is given when the distance to any of the reconnaissance targets M1-9 or S1-9 is less than the entered value. If multiple warnings are given, only the closest target is displayed.

Warning is not presented during start/landing, and any present warning is cancelled on selecting any of the landing master modes.

Warning is not presented during weapons use / aiming (either in mode ANF or trigger is UNSAFE). However, any present warning is *not* cancelled by weapons use / aiming.

Indication

Stand-off warning is indicated by:

- Flashing, fully extended time / distance line in the HUD.
- Flashing number in the destination indicators second digit as well as a “temporary” destination change to the warned target. This will result in:
 - Warning in the destination indicator.
 - Distance on the distance indicator.
 - Heading bug on the course ring.
 - Left / right displacement on the HUD and the ADI flight director needles
 - Direction / distance of the circle marker on the CI.

Cancellation

Stand-off warning is cancelled in the one of these two ways:

- Cycling the fix trigger from the first detent (T0-T1-T0). The warned target is set as the destination. Warned tracked target (SKU) is only cancelled in master mode SPA.
- Manual destination change. Warning is cancelled and selected waypoint becomes the destination.

Non-cancelled warnings last until the warning parameters are no longer fulfilled. When this occurs, the most recent waypoint (LS, B1 – B9, or L1, L2) will be selected as the destination.

Note. Fix taking is inhibited as long as the stand-off warning is active.

Input

In mode TAKT, a Stand-off warning distance can be entered. All targets (M1-9, S1-9) will share the same stand-off distance. Input can be made in any master mode.

Input is made on address 30 and then the desired warning distance (01-99 km) and confirming by pressing waypoint button LS / SKU. Input of 00 km means that no warning is given. Example: 303500 for 35 km.

Stand-off warnings are cleared on setting the master mode selector to BER after landing, or clearing in mode TAKT (Pressing the RENSA / Clear button while in TAKT).

Output VIND/RUTA/MÅL in mode SPA

Coordinates for corner and centre points of the RUTA patrol square can be displayed by pressing and holding the corresponding waypoint button (B1-B9).

Readout of the measured reconnaissance targets is done by pressing and holding the corresponding target number on the data panel.

Output TID in mode SPA

Manual Timestamp

Timestamp readout for measured reconnaissance targets is done by pressing the corresponding number button (B2 for M2) on the data panel.

Output TAKT in mode SPA

Stand-off distance

Current stand-off distance can be displayed by entering address 30 in TAKT/IN and pressing LS/SKU to confirm.

Example: 303500 for 35 km stand-off warning from all reconnaissance targets (M1-9, S1-9).

8. EMERGENCY PROCEDURES



Some of the following procedures are printed on the left and right placards on the inside of the glare shield.

Engine fire

On right placard.

Fire suspected: (fire indicator light lit or other suspicion)	
Low pressure fuel valve (LT- KRAN):	OFF.
Lowest possible RPM.	
AIRCRAFT ON FIRE: NO	
Land as soon as possible.	
Aircraft on the ground:	
Throttle:	OFF.
> 3 seconds: Main power (HUVUDSTRÖM):	OFF.
Egress aircraft as soon as possible.	
AIRCRAFT ON FIRE: YES	
EJECT	EJECT

Engine flameout

On left placard.

Sudden engine RPM and temperature decrease	
Throttle:	Ground idle
Decrease altitude below 12 km (12.000m or 40.000 ft).	
ENGINE restart (ÅTERSTART).	Press 2 seconds
Manual fuel regulator (BRÄNSEREGULATOR).	Manual (MAN)
If no RPM or EGT increase within 20 seconds:	
Engine start switch (START)	(Normal engine start procedure).
Fly gently.	
Land as soon as possible.	

Engine compressor stall / surge

On left placard.

Reduce AoA (α) and G-load (nz)
Maintain throttle.
If atypical compressor stall / surge (indicating an engine fault)
AND / OR compressor stall / surge remains:
Reduce throttle below afterburner.
Highest possible RPM.
Fly gently.
Land as soon as possible.

Abnormal thrust following compressor surge / stall

On left placard.

Fly gently	
Engine nozzle position	
OPEN	CLOSED
If required: Jettison weapons stores (press NÖD-FÄLLNING VAPEN)	Throttle: In-flight idle, Reduce altitude below 9 km (9000 m / 30.000 ft)
	Manual fuel regulator (BRÄNSE-REGULATOR): Manual (MAN)
	EGT: Max 570° C
	If required: Jettison weapons stores (press NÖDFÄLLNING VAPEN)
Land as soon as possible / Eject	

Reduced thrust after take-off

On cover below the Head Up Display (HUD). In case of a suspected reduction in engine thrust.

Throttle: Military power (max dry thrust)
If problem persists:
Manual fuel regulator (BRÄNSEREGULATOR): MAN
If required: Jettison weapons stores (press NÖDFÄLLNING VAPEN)
Fly gently
Land as soon as possible
If take-off cannot be completed or aborted: EJECT

9. APPENDICES



I. Mission Editor Settings

Mission Editor Waypoints

Beyond the normal waypoint and other common DCS settings, the DCS AJS-37 has added the functionality of setting the BX and R points in the editor.

BX Markpoints

BX Markpoints are set via the "Navigation Target Point" tab on the "Airplane group" page, assuming the aircraft group is set either to "Player" or "Client" (AI units have no use for these types of points).

BX points should be formatted as "BX1" for BX1. RB15 points, BX6-9 are formatted similarly. The "number" of the point does not matter as long as the formatting is correct. These points will then be loaded into the data cartridge and will be loaded along with the other normal waypoints

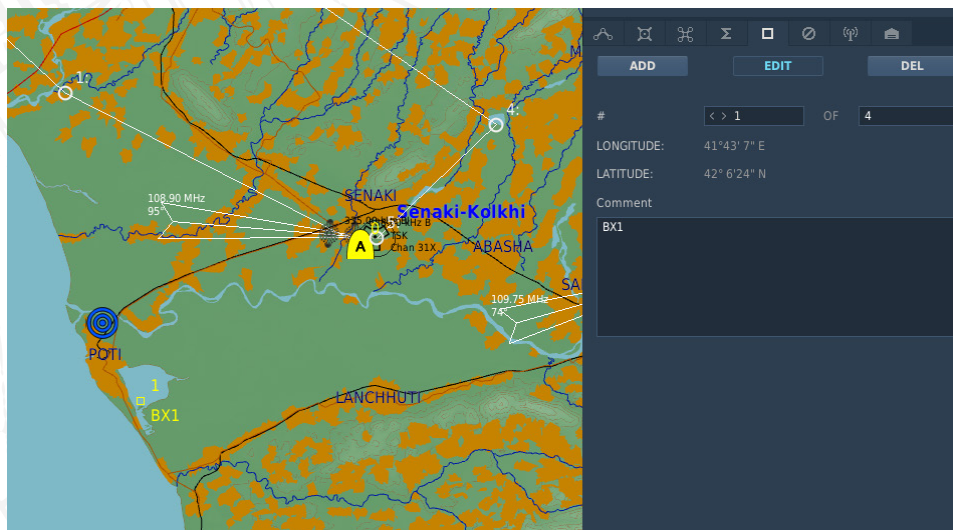

Figure 240. BX1 set.

BX points should be formatted as "BX1" for BX1. RB15 points, BX6-9 are formatted similarly.

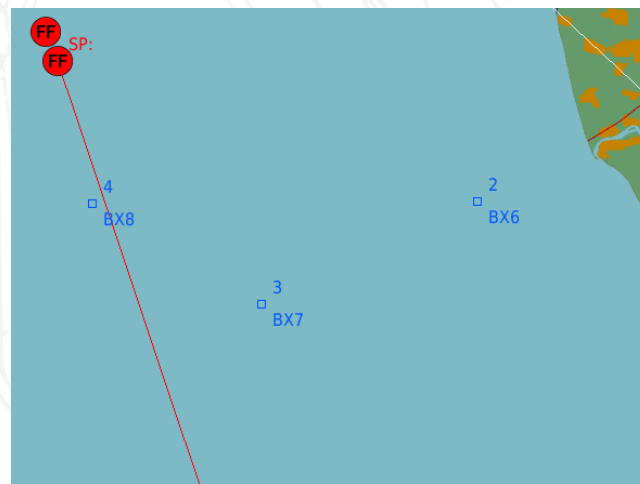

Figure 241. RB15 BX points BX6-8 set..

RUTA (R) Reconnaissance Corner and Centre points

Reconnaissance corner and centre points set via the "Navigation Target Point" tab on the "Airplane group" page in the mission editor, assuming the aircraft group is set either to "Player" or "Client" (AI units have no use for these types of points).

Corner and Centre points are formatted as: "R1" for corner point R1.

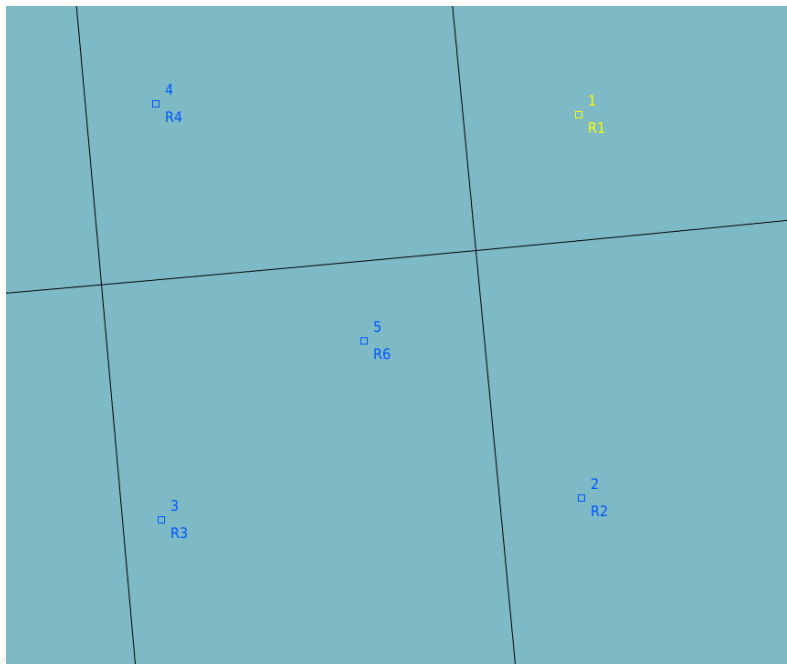

Figure 242. R1-4 added as corner points . R6 set as centre point.

Mission editor weapon settings

In the "Additional properties for aircraft" tab on the "Airplane group" page, a number of weapon settings can be preset. These are settings that in real life are set in either the apparatus bay or on the weapon itself by either the pilot or the crew chief, such as safety or seeker settings.

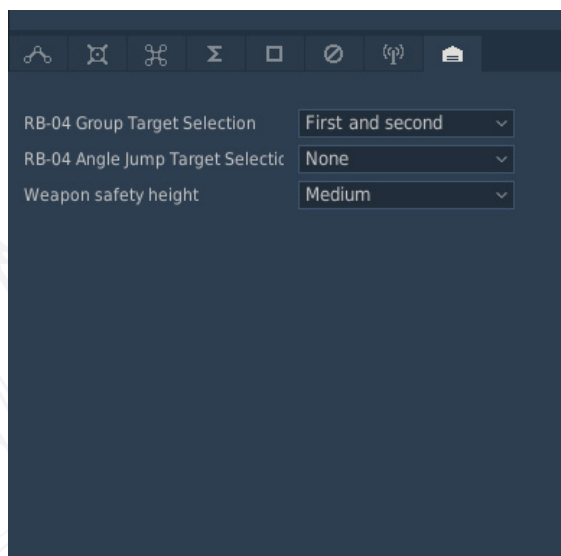

Figure 243. Additional properties for aircraft tab.

Safety height:

Sets the safety altitude for weapons. This will affect values such as minimum firing distances for rockets and commanded altitude for level bombing.

Can be set to either *Low*, *Medium*, or *High*.

Values for each height preset varies with the weapon system and mode used.

In general, a higher setting will be safer, but less accurate. Set to *medium* by default.

RB04 Group target selection

Sets which "row" of targets are selected for each missile.

First and Third: Missiles 1 will select the first row, missile two will select the third row.

First and Second: Missile 1 will select the first row, missile two will select the second row.

Second and Third: Missile 1 will select the second row, missile two will select the third row.

Random: Missiles will be randomly assigned. (Preferable unless very detailed planning is involved)

Please refer to the RB04 procedures section for more detailed information.

RB04 Angle Jump

Please refer to the RB04 procedures section for more detailed information.

Can be used to force the missile to select the second column detected by the seeker (usually to the right from the perspective of the missile) in order to spread out which column is selected by multiple missiles when released by aircraft on the same approach vector.

Generally only useful for when attacking very large ship formations with multiple aircraft at the same time in multiplayer. Set to none by default.

None: Missiles will select the first valid group detected.

Left: The left missile will select another column.

Right: The right missile will select another column.

Both: Both missiles will select another column.

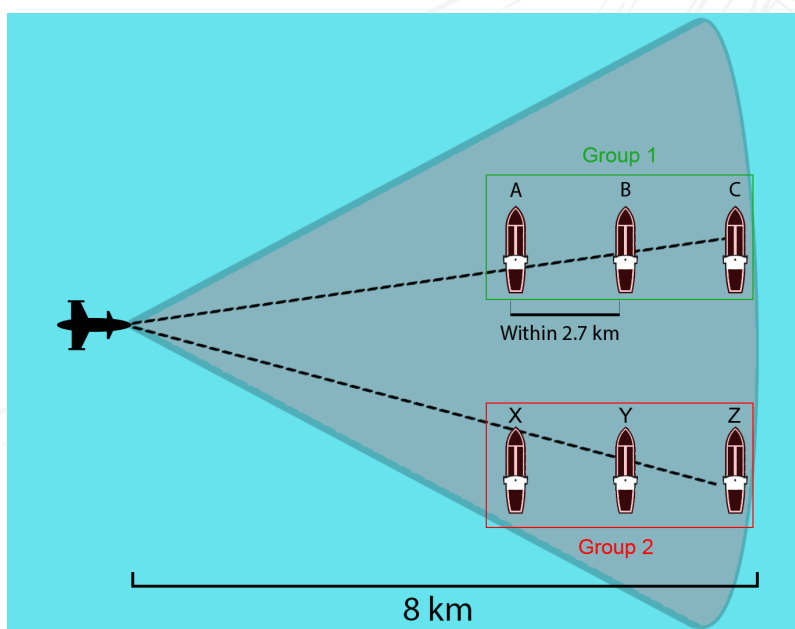

Figure 244. Angle jump. If angle jump is selected, the missile would select Group 2 (ships X, Y, Z). If angle jump (as per default) is not selected, the missile will select the first valid group detected likely Group 1 (ships A, B, C).

II. Data Cartridge system

Types of cartridges

With the DCS AJS-37 Viggen, there are several types of data cartridges available.

Press L-ALT, L-Ctrl +C or L-Shift, L-Ctrl + C to cycle between the available cartridges.

After selecting your cartridge, load normally using the REF-LOLA/IN, 9099 method.

Note: It is possible for the mission maker to disallow the different types of cartridges in the "additional properties for aircraft" tab.

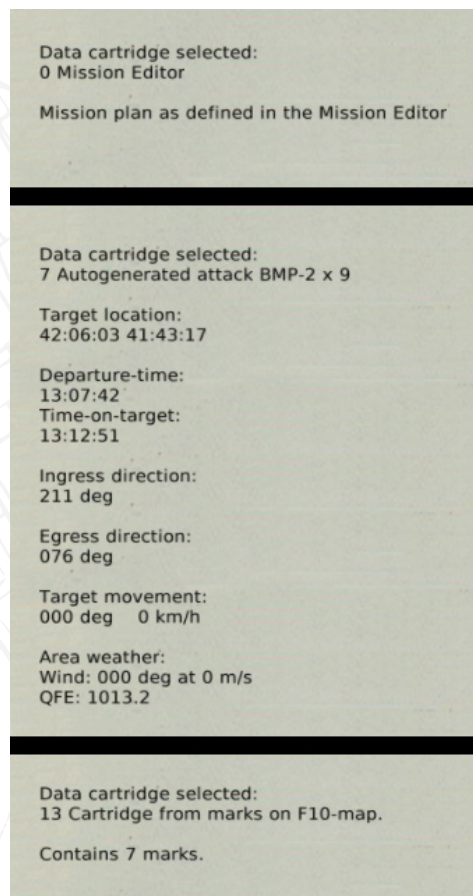

Figure 245. Examples of different types of data cartridges (Mission editor, Auto-generated, and F10 marks).

Mission Editor cartridge

The flight-plan as designed by the mission maker.

Auto-generated cartridge

The system will automatically generate a flightplan towards a hostile group. Cycle between cartridges for different groups.

F10 Map generated cartridge

The cartridge can be created based on setting marks on the in-game F10 Map.

Place a mark on the desired coordinate, and use the following format for the different types of waypoints:

Airfields LS L1 L2:

Waypoints B1-9: B1, BP1

Target waypoints M1-9: MP1 MB1 MBP1

Markpoints: BX1-9: BX1

Measured Recce targets M1: M1, MR1

RUTA points R1-9: R1-9

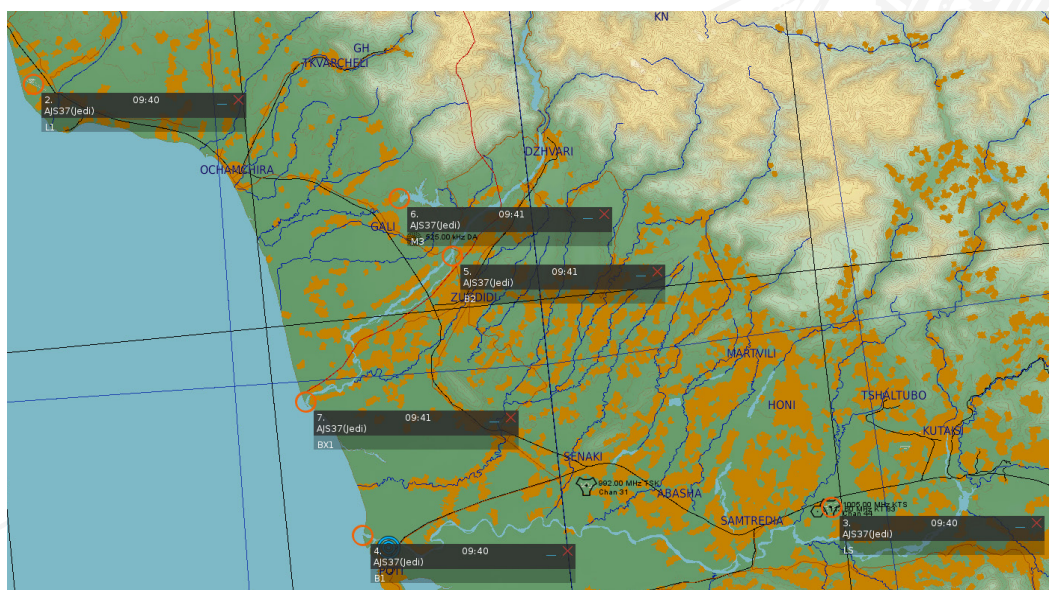

Figure 246 Example of F10 map marks.

External cartridges

The system allows cartridges to be created via editing a LUA file in the saved-games folder, or using external software such as CombatFlite.

This page intentionally left blank



CREDITS

Heatblur Simulations

Christoffer Wärnbring - Lead Programmer
 Daniel Malmquist - Weapons Programmer
 Krzysztof Sobczak - Programmer
 Bert Van Leeuwen - Programmer

Nicholas Dackard - Lead Artist/3D/2D/VFX
 Anders Karlsson - 3D/Animation
 Andreas Sandin - 2D/Documentation
 Stirling Rank - 3D Softsurface Sculpting
 Bartosz Lemke - 3D
 Andrzej Osiecki - 3D

Teodor Frost - Lead QA, Research, Documentation, Missions
 Aleksander Studen-Kirchner - Community Management, Voice Directing, Testing, Editing.

Testers

Alexander Jacobs
 Daniel Striby
 Jonathan Törnkvist
 Ola Nykvist
 Rickard Lundgren
 Johan Malmquist
 Martin Wall
 Emil Sundberg

Special thanks

Eagle Dynamics
 Matthew Wagner
 Jonas Lundh
 Joachim Hultgren
 Mattias Nordgren
 The wonderful people at the Masterarms community for all of their support.
 Novak Djordjijevic
 Radu Manole
 Michael Carter II
 Igor Tishin
 Alexander Oyikin
 Peter Collins
 Chris Ellis
 CJ Soques
 Thomas Tyrell
 Sam Johnson
 Mike Sto

www.HeatBlur.com

Thank you for your support!

